

GranQuartz

EVERYTHING

For The Stone Industry Professional

Over 10,000 Products!

- **NEW! Silica Dust Control & Elimination Products Special Section**
- **NEW! Thin Panel Porcelain Tools and Equipment Special Section**

1-800-458-6222
GranQuartz.com

2020



Cyclone® Ultra
UCS/Porcelain Blade p. 133



Pearl®
VX5XWV Saw p. 223



Nemo® Grabo
Vacuum Cup p. 161

GranQuartz
Visit one of our 13 Stores!

ONE DAY Shipping Nationwide!*

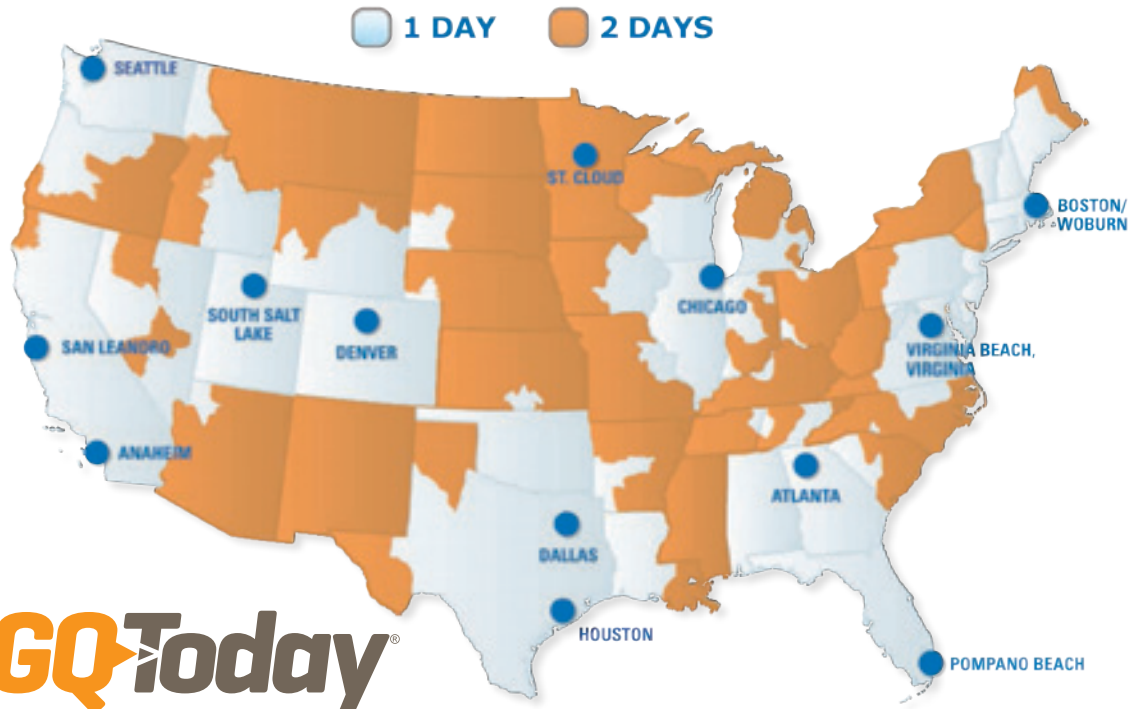

GQ Today

SAME DAY Delivery NOW AVAILABLE in 14 Major Markets!
Call for details or visit granquartz.com.

13 Regional Shipping Locations Ensure Fast Delivery and LOW Freight Costs!

Atlanta - 770-621-9777
3950 Steve Reynolds Blvd., Norcross, GA 30093

Anaheim - 714-905-5400
1201 E. Ball Road, Ste. K, Anaheim, CA 92805

Boston/Woburn - 508-915-4213
185 New Boston Street, Woburn, MA 01801

Chantilly, VA - 703-234-2180
14110 Sullyfield Circle, Ste. F, Chantilly, VA 20151

Chicago - 847-787-0900
1111 Chase Ave., Elk Grove Village, IL 60007

Dallas - 972-865-4786
1400 I35E, Carrollton, TX 75006

Denver - 303-733-6840
1020 S. Jason St., Denver, CO 80223

Houston - 832-467-0400
13230 Hempstead, Ste. 300, Houston, TX 77040

Pompano Beach - 954-974-5999
2210 N.W. 15th Ave., Pompano Beach, FL 33069

San Leandro - 510-924-0914
2781 Teagarden St., San Leandro, CA 94577

Seattle - 206-973-7640
Northwest Corporate Park, Building B
6001 6th Avenue South, Seattle, WA 98108

S. Salt Lake - 801-203-3791
2876 South 300 W. South Salt Lake, UT 84115

St. Cloud - 320-251-8600
820 Sundial Dr., Waite Park, MN 56387

*One day shipping to 75% of the contiguous U.S.



WARNING! Abrasive products **MUST NOT** be used without proper personal protective equipment and approved dust control methods. Failure to do so may result in the inhalation of respirable crystalline silica and can cause serious or fatal respiratory diseases, including silicosis.

Dust and Silica Warning The use of abrasive tools generate dust. This dust may contain respirable crystalline silica. Repeated and/or substantial inhalation of airborne crystalline silica can cause serious or fatal

respiratory diseases, including silicosis. In addition, California and some other authorities have listed respirable crystalline silica as a substance known to cause cancer.

These products **MUST NOT** be used without (1) proper personal protection equipment that has been fit tested to the worker, and (2) dust containment and collection systems, or (3) integrated water delivery systems. Acceptable work practices and recommendations for dust control methods

can be found in the **29 CFR § 1910.1053**.

If you are unfamiliar with the risks associated with cutting, grinding, or polishing quartz, quartzite, granite, sintered material, concrete, mortar, brick, or block, please review the products' material safety data sheet and/or consult your employer, the manufacturers/suppliers, or governmental agencies such as **OSHA** and **NIOSH** and other sources on the hazardous of these materials.



Warning! Products can expose you to chemicals which are known to the State of California to cause cancer, birth defects or other reproductive harm.

California residents see all prop 65 warnings at www.p65Warnings.ca.gov

TABLE OF CONTENTS

[Index: pages 246-247]

1 - BLADES

Turbo Blades.....	3-7
Specialty Blades (Marble, Contour, Tile, UCS, etc.)	7-17
Bridge Saw Blades.....	18-33
Milling Wheels.....	34

2 - POLISHING PADS, SANDPAPER & ACCESSORIES

Polishing Pads.....	35-44
Specialty Polishing Pads.....	45-50
Sandpaper.....	51-54
Hand Pads & Polishing Drums.....	55-56

3 - CORE BITS & ACCESSORIES

Wet Use Core Bits.....	57-58
Dry Use Core Bits.....	59-60
1/2" Gas Core Bits, Specialty Core Bits.....	61-62
Water Jackets & Adapters.....	63

4 - CUP WHEELS & GRINDING STONES

Tornado System Grinding Wheels.....	63
Diamond Cup Wheels.....	64-67
Silicon Carbide Grinding Wheels.....	68

5 - ROUTER BITS, PROFILING TOOLS & SPECIALTY BITS

Router Bits (Diamond, Electroplated).....	69-73
Profiling Bits.....	73-74
T-31 Anchor Bits & Accessories.....	75
Die Grinder Tooling.....	76

6 - CNC MACHINE TOOLING

CNC Vacuum Pods.....	77-79
ADI® CNC Program Overview.....	80-83
CNC Profile Wheels.....	84-88
CNC Finger Bits.....	89-91
Stubbing Wheels.....	92
Adapters, Connection Cones.....	92-93
CNC Core Bits.....	94
Zoller Smile Pilot, Advant Edge.....	95
CNC Blades, Tool Dressing Stones.....	96

7 - AUTO EDGE MACHINE TOOLING

Flat Polishing, 3-Step Systems, 5-Step Systems.....	96-97
ADI® Auto Edge Wheels.....	98-100
Straight Edge Polish Wheels.....	101
Bullnose Polish Wheels.....	102
Combo Polish Wheels.....	103-107
Leather Texture Effect/Antiquing Brushes.....	108-109

8 - RADIAL ARM MACHINE TOOLING

Incremental Cutting Finger Bits, Finishing Brushes.....	111-112
Top Polishing.....	113
Bush Hammer Plates, Grinding Drums.....	114-115

9 - ENVIRONMENTAL SAFETY

DuroAir Dust Containment & Air Cleaning Systems..	116
Weha Dust Walls, Novair HEPA Filtration Systems..	117
HEPA Vacuums, Aztec® Floor Scrubber.....	118
Dust Guards & Shrouds (for Grinders).....	119
Particulate Respirators, Dust Maks.....	120
Water Recycling/Reclamation Systems.....	121-122

10 - LARGE EQUIPMENT

Sasso America Flying Fla Vertical Edge Polisher.....	123
Farnese Bridge Saws.....	124-125
Farnese Alexia Sink Cutout System.....	126
Fab King Sink Cutout System.....	127
Farnese Technicut CNC Bridge Saw.....	129

11 - PORCELAIN FABRICATION TOOLING & EQUIPMENT

Material Handling Equipment.....	130-131
Alpha Cutting Tools and Equipment.....	132
Blades, Cup Wheels & Core Bits.....	133

12 - MATERIAL HANDLING

Gorbel Cranes & Hoists.....	134
-----------------------------	-----

Manzelli Vacuum Lifters.....	130,135-136
Slab Lifters & Accessories.....	136-138
Transport Racks, Carts.....	138-139, 145
Carts, Self-Dumping Hopper.....	140
Fabrication Tables.....	141-144, 149
Booms.....	146-147
Slab & Bundle Racks.....	147-148
Carry Clamps & Dollies.....	149-150, 132

13 - INSTALLATION SUPPLIES

Omni Cubed.....	151-158
Suction Cups & Seam Setters.....	159-161
Sinks.....	162
Sink Installation Products.....	163-166
Protective Film, Drop Cloth, Builder's Paper.....	167
Corbels, Fiberglass Reinforcement Rodding.....	168
Tuscan Leveling System, Pearl® Smart Spacers.....	169

14 - STONE RESTORATION & CARE

Repair Supplies.....	170
Surface Prep Products.....	171
Surface Machines.....	171-172
Floor Polishing Pads, Buffing Pads.....	173-175
Shop Vacs.....	176
Floor Grinding Discs & Pads.....	177-178

15 - ADHESIVES

Polyester, Hybrid Adhesives.....	179-159
Superior® Adhesives, Coloring Paste.....	180-182
Akemi® Adhesives, Coloring Paste.....	183
Tenax® Adhesives.....	186-187
Nitro® One Shot Adhesives.....	188
Adhesive Guns, Colorants, Accessories.....	188-189
Repair Kits, Tape, Hot Glue Guns, Caulk Guns.....	191-192
Adhesive Caulks.....	193

16 - FABRICATION CHEMICALS

Impregnators, Sealers.....	194-198
Color Enhancers.....	194-197
Cleaners, 113M 3-IN-1.....	198-199
Waxes & Polishes.....	200
Honing Powder, Marble Polish.....	201-202
Reulin Powder, Felt Buffing Pads.....	203

17 - SHOP SUPPLIES

Clamps, 90° Mitre Clamp, OmniCubed Miter-It™.....	204
Waterproof Fabrication Shop Clothing.....	205-206
Dust Masks, Hearing/Eye Protection.....	207-209
China Markers, Coilhose Blow Guns.....	210
Levels & Squares, Utility Knives, Razor Blades.....	211

18 - POWER TOOLS & ACCESSORIES

Grinders.....	212-213
Polishers, Electric.....	214
Polishers, Pneumatic Waterfed.....	215-217
Polishers, Electric Dry Use.....	218
Sanders & Die Grinders.....	218
Cutting Guards, Dust Shrouds.....	219
Back-Up Heads & Pads.....	219-220
NSI Seam Phantom, NSI Floating Turbo Wheels.....	221
Saws - Circular, Track Saws, Pneumatic.....	217, 222-224
Saws - Tile.....	225-226
Achilli Jobsite Saws.....	226-231
Fluting & Chiseling Tools.....	232
Magnum Routers.....	233
Marmomechannica Master Router.....	234
Aqua Router, Klindex Planetary Polisher.....	235
T-31 Machines & Anchor Bits.....	236
Power Tool Accessories.....	237

19 - MONUMENT TOOLS & SUPPLIES

Stencil Cutting Supplies.....	238-240
Lifting/Transport Supplies and Equipment.....	241-242



NEW for 2020!

More Innovations in Fabrication Equipment and Supplies, From GranQuartz®

GranQuartz is the leading distributor of stone fabrication, tile and concrete tooling and supplies with nearly 40 years of experience and is the trusted partner you can rely on to help ensure the success of your business. Whether we serve you through our experienced staff of sales professionals, retail stores and distribution centers, catalogs, telemarketing or e-commerce, we are always here when you need us!



Ad-Vise CNC Tool Press
#981771, P.93



Achilli® AFR 300 A-ZM Bridge Saw
#053307, P.228



DuroTower® Cleaning Systems
#491042, P.116



Cyclone® Ultra UCS/Porcelain Blade
#052571, P.133

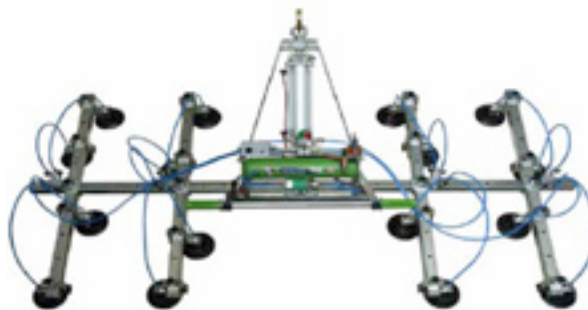

Manzelli® EXE 16PN GRES Thin Material Power Tilt Lifter
#490737, P.130



Black Magic® Combo Edge Polishing Wheels
#113968, P.105



Diasant® Pulsar Patterned Diamond Blade
#445115, P.22



Diamond Wright® Electroplated CNC Fingerbit
#924008, P.90

TURBO BLADES

PEARL



Pearl® P5™ Professional Granite Blade

- 8mm Rim height
- High diamond concentration for extra long life
- Turbo rim for fast cut and minimal chipping
- Wet or dry cutting

Stock No.	Diam.	Arbor Size	Price
940400	4"	20mm - 5/8"	\$43.95
940450	4 1/2"	7/8" - 5/8"	49.95
940500	5"	7/8" - 5/8"	59.95
940697	5"	20mm - 4 hole	59.95
940501	6"	7/8" - 5/8"	75.95
170927	6"	20mm - 4 hole	75.95
940700	7"	5/8", \diamond	88.95
940699	7"	20mm - 4 hole	88.95

PEARL



Pearl® P5S Turbo Blade

- 8mm Rim height
- Wet or dry cutting
- For granite, natural stone and engineered stone surfaces, concrete

Stock No.	Diam.	Arbor Size	Price
677100	4 1/2"	7/8" - 5/8"	\$54.86
677101	5"	7/8" - 5/8"	65.73
677102	6"	7/8" - 5/8"	71.03
677103	7"	5/8", \diamond	75.83

PEARL



Pearl® P4™ Super Dry Blade

- 8mm Rim height
- Extra long life
- Waved design adds stability to the steel core, reduces friction, and removes the debris from the cutting path, extending blade life
- Wet or dry cutting

Stock No.	Diameter	Arbor Size	Price
115764	4"	20mm-5/8"	\$54.95
115767	4 1/2"	7/8" - 5/8"	59.95
115794	5"	7/8" - 5/8"	76.55
115970	7"	7/8", \diamond , 5/8"	88.95
115973	8"	5/8", \diamond	128.95
115975	10"	5/8"	211.95
116321	12"	1"	255.00

PEARL



Pearl® P5™ Super Dry Blade

- 8mm Rim height
- High diamond concentration for extra long life
- Waved core design adds stability, reduces friction, and removes the debris from the cutting path
- Extended diamonds on the rim and embedded diamond segments in steel core reduces under-cutting and keeps the blade cool
- Wet or dry cutting

Stock No.	Diameter	Arbor Size	Price
940150	4"	20mm - 5/8"	\$60.95
940152	4 1/2"	7/8" - 5/8"	67.20
940155	5"	7/8" - 5/8"	80.70
940157	7"	7/8", \diamond , 5/8"	99.30
940158	8"	5/8", \diamond	131.40
940159	10"	5/8", \diamond	226.95

ALPHA



Alpha® Quad Turbo Blade

- 8mm Rim height
- Use with Quad Adaptor for flush cutting applications- Quad Drive Adapter eliminates the typically required lock nut
- Make 90° inside corners cleanly and efficiently
- Wet or dry cutting

Stock No.	Diameter	Arbor Size	Price
116063	4" Quad	20mm	\$53.45
116067	5" Quad	20mm	67.26
116070	6" Quad	20mm	79.44
116072	7" Quad	20mm	84.72
116074	8" Quad	20mm	103.15
116077	9" Quad	20mm	156.20
116075	10" Quad	20mm	175.68



Alpha® Plus Turbo Blade

- 8mm Rim height
- Use on angle grinders, wet stone cutters and demolition saws
- Wet or dry cutting

Cutting Speed

Blade Life

Smooth Cuts

Stock No.	Diameter	Arbor Size	Price
899200	4"	20mm - 5/8"	\$51.32
899203	4 1/2"	7/8" - 20mm	56.39
899206	5"	7/8" - 20mm	64.99
899209	6"	5/8",	77.02
899212	7"	5/8",	81.79
899215	8"	5/8",	98.88
899224	10"	1" - 5/8"	172.05
899221	10"	1" - 5/8"	172.05
899230	12"	20mm	216.17



Legend® Turbo Blade

- High diamond concentration for extra long life
 - Fast cutting
 - 8mm Rim height
 - Wet or dry cutting
- Premium diamond formulation and narrow cutting flutes provide clean chip-free cuts. Legend Turbo blades are among the fastest, most aggressive granite cutting blades on the market.

Cutting Speed

Blade Life

Smooth Cuts

Stock No.	Diameter	Arbor Size	Price
920652	4 1/2"	7/8"-20mm-5/8" 4-hole	\$31.95
920653	5"	7/8"-20mm-5/8" 4-hole	34.95
920654	6"	7/8"-20mm-5/8" 4-hole	47.95
920655	7"	7/8"--5/8"	65.95



Pulsar® Turbo Blade

- Quad adapter holes (4" - 6" diam.) for flush cutting applications
- Fast, clean cutting
- 8mm Rim height
- Wet or dry cutting

Thin kerf allows for fast and clean cutting, the Pulsar is an economical option that provides high quality.

Stock No.	Diam.	Arbor	Price
445180	4"	7/8"-20mm-5/8" 4-hole	\$22.92
445181	4 1/2"	7/8"-20mm-5/8" 4-hole	26.67
445182	5"	7/8"-20mm-5/8" 4-hole	27.00
445183	6"	7/8"-20mm-5/8" 4-hole	41.25
445184	7"	7/8"--5/8"	55.50
445185	8"	7/8"--5/8"	64.00



Pro Series® Turbo Blade

- For Granite, Marble & Engineered Stone
- 8mm Rim height
- Wet or dry cutting

Stock No.	Diam.	Arbor	Price
600260	4"	7/8"-20mm-5/8" 4-hole	\$25.95
600261	4 1/2"	7/8"-20mm-5/8" 4-hole	29.95
600262	5"	7/8"-20mm-5/8" 4-hole	32.95
600263	6"	7/8"-20mm-5/8" 4-hole	45.95
600264	7"	7/8"--5/8"	63.95
600269	7"	7/8"-5/8", 4-Hole	65.95
600265	8"	7/8"--5/8"	75.95



Pro Series® PLUS Turbo Blade

- Superior cutting and premium performance.
- 9.5mm Rim height
- Wet or dry cutting

Stock No.	Diam.	Arbor	Price
119050	4 1/2"	7/8"-20mm-5/8" 4-hole	\$44.45
119051	5"	7/8"-20mm-5/8" 4-hole	46.50
119052	6"	7/8"-20mm-5/8" 4-hole	58.95
119053	7"	7/8"--5/8"	81.95



Cyclone® "S" Turbo Blade

- Designed for fast, clean cutting.
- Special core reduces noise by over 10 decibels
 - Stable vibration free cutting
 - Cut over 1,000 feet when used wet
 - Wet or dry cutting

Stock No.	Diam.	Arbor Size	Price
052535	5"	7/8"-22mm-5/8", 4-hole	\$34.95
052527	5 1/2"	7/8"-22mm-5/8", 4-hole	41.95
052536	6"	7/8"-22mm-5/8", 4-hole	47.95
052537	7"	7/8"--5/8"	65.95
052538	8"	7/8"--5/8"	75.95



Xpert "S" Turbo Blade

The Xpert S turbo blade delivers high performance at mid-grade pricing and will outperform many higher priced turbo blades. High Diamond Concentration provides fast and clean cutting performance with long life.

- High performance wet or dry cutting
- Fast, clean cutting on granite or engineered stone

Stock No.	Diam.	Arbor	Price
359130	4 1/2"	7/8"-20mm-5/8" 4-hole	\$19.95
359131	5"	7/8"-20mm-5/8" 4-hole	22.50
359132	6"	7/8"-20mm-5/8" 4-hole	27.25
359133	7"	7/8" - \diamond - 5/8"	39.95



Cayenna Turbo Blade

The large segment design of this blade cuts aggressively, while the tall diamond segment provides excellent life.

- Wet or dry cutting

Stock No.	Diam.	Arbor	Price
359119	4 1/2"	7/8"-20mm-5/8" 4-hole	\$11.50
359120	5"	7/8"-20mm-5/8" 4-hole	12.50
359121	6"	7/8"-20mm-5/8" 4-hole	15.50
359123	7"	7/8" - \diamond - 5/8"	20.50



Assassin® II Turbo Blade

Great for wet or dry cutting granite.

- 10mm Rim height

Cutting Speed	★★★★★
Blade Life	★★★★★
Smooth Cuts	★★★★★

Stock No.	Diam.	Arbor Size	Price
620016	4 1/2"	7/8"-20mm-5/8" 4-Hole	\$22.74
620013	5"	7/8"-20mm-5/8" 4-Hole	23.37
620014	6"	7/8"-20mm-5/8" 4-Hole	26.65
620017	7"	7/8" - \diamond - 5/8"	37.56

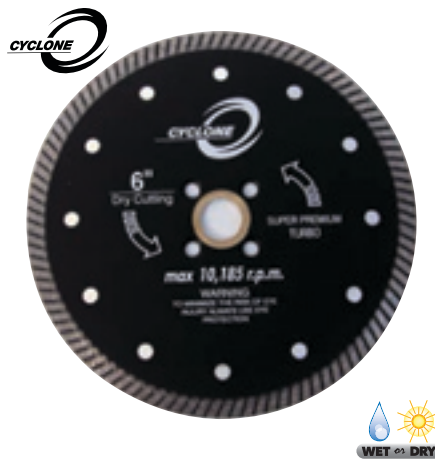

Cyclone® Turbo Blade

- 8mm Rim height
- Wet or dry cutting

Stock No.	Diam.	Arbor Size	Price
600250	4"	7/8"-20mm-5/8" 4-hole	\$26.95
600251	4 1/2"	7/8"-20mm-5/8" 4-hole	31.95
600252	5"	7/8"-20mm-5/8" 4-hole	34.95
600253	6"	7/8"-20mm-5/8" 4-hole	47.95
600258	7"	7/8"-5/8" 4-Hole	65.95



Assassin® Turbo Blade

Best performing economy turbo blade in the industry. Consistently cuts granite, marble, engineered stone and ceramic tile.

- 8mm Rim height
- Wet or dry cutting

Stock No.	Diam.	Arbor Size	Price
620000	4"	7/8"-20mm-5/8" 4-Hole	\$17.59
620005	4 1/2"	7/8"-20mm-5/8" 4-Hole	18.59
620010	5"	7/8"-20mm-5/8" 4-Hole	19.59
620011	6"	7/8"-20mm-5/8" 4-Hole	21.70
620015	7"	7/8" - \diamond - 5/8"	31.95

Cutting Speed	★★★★★
Blade Life	★★★★★
Smooth Cuts	★★★★★



Pro Series® EXW Turbo Blade

Unique rim design reduces friction for very fast cutting with minimal chipping. Great performance when making forward or reverse cuts on UCS (Ultra Compact Surfaces), Granite, Porcelain or Engineered Stone surfaces.

- Fast cuts with minimal chipping
- Unique side diamond for cleaner cuts
- Wet or dry use (wet only if cutting UCS)

Stock No.	Diam.	Arbor Size	Price
600753	4 1/2"	7/8"-20mm-5/8" 4-hole	\$32.50
600754	5"	7/8"-20mm-5/8" 4-hole	33.50
600755	6"	7/8"-20mm-5/8" 4-hole	39.95
600756	7"	7/8"-◇-5/8"	53.50



Assassin® EXW Blade

Extra wing side segment for added core protection and aggressive cutting, the EXW is ideal for use in the roughest conditions.

- 8mm Rim height
- Wet or dry cutting

Stock No.	Diam.	Arbor Size	Price
112912	4 1/2"	7/8"-20mm-5/8" 4-hole	\$29.95
112913	5"	7/8"-20mm-5/8" 4-hole	30.95
112914	6"	7/8"-20mm-5/8" 4-hole	37.95
112915	7"	7/8"-◇-5/8" 4-hole	50.95



Q4 Samurai Turbo Blade

Offset protruding side segments help prevent binding and increase cutting speed.

- Wet or dry cutting

Stock No.	Diam.	Arbor	Price
359018	4 1/2"	7/8"-20mm-5/8" 4-hole	\$28.44
359019	5"	7/8"-20mm-5/8" 4-hole	32.95
359027	6"	7/8"-20mm-5/8" 4-hole	42.18
359020	7"	7/8"-◇-5/8"	51.87
359021	8"	7/8"-◇-5/8"	56.94



Assassin® EXT Blade

Extra thick core with side segments for added core protection. Waved core increases cooling for improved performance.

- 8mm Rim height
- Wet or dry cutting

Stock No.	Diam.	Arbor Size	Price
620001	4"	7/8"-20mm-5/8" 4-hole	\$26.50
620002	4 1/2"	7/8"-20mm-5/8" 4-hole	29.00
620003	5"	7/8"-20mm-5/8" 4-hole	32.00
620006	6"	7/8"-20mm-5/8" 4-hole	41.00
620004	7"	7/8"-◇-5/8"	49.50



Recon™ Turbo Blade

Great for granite, marble, engineered stone and ceramic tile.

- 8mm Rim height
- Wet or dry cutting

Property	Rating
Cutting Speed	★★★★
Blade Life	★★★★
Smooth Cuts	★★★★

Stock No.	Diam.	Arbor Size	Price
695923	4"	7/8"-20mm-5/8" 4-Hole	\$20.95
695924	4 1/2"	7/8"-20mm-5/8" 4-Hole	25.95
695931	5"	7/8"-20mm-5/8" 4-Hole	28.95
698855	6"	7/8"-20mm-5/8" 4-Hole	36.95
698858	7"	7/8"-◇-5/8"	42.95



PEARL

Pearl® P3™ Turbo Blade

- 8mm Rim height
- Long life
- Turbo rim for fast cut and minimal chipping
- Wet or dry cutting

Stock No.	Diameter	Arbor Size	Price
990156	4".....	7/8"-20mm-5/8" 4-Hole	\$21.20
990157	4 1/2".....	7/8"-20mm-5/8" 4-Hole	25.95
990158	5".....	7/8"-20mm-5/8" 4-Hole	28.45
990159	6".....	7/8"- 5/8"	34.10
990160	6".....	7/8"-20mm-5/8" 4-Hole	34.10
990161	7".....	7/8"- 5/8"	40.30
990162	7".....	7/8"-20mm-5/8" 4-Hole	40.30



Hurricane™ Turbo Blade

Hurricane Turbo Blades are formulated for quick cutting performance at an economy price.

- 8mm Rim height
- Wet or dry cutting

Stock No.	Diam.	Arbor Size	Price	Stock No.	Diam.	Arbor Size	Price
600244	4".....	7/8"-20mm-5/8" 4-Hole.....	\$24.75	600277	6".....	7/8"-20mm-5/8" 4-Hole.....	\$39.95
600275	4 1/2".....	7/8"-20mm-5/8" 4-Hole.....	25.80	600278	7".....	7/8"- 5/8"	51.70
600276	5".....	7/8"-20mm-5/8" 4-Hole.....	30.95	600279	7".....	7/8"-5/8" 4-Hole.....	51.70



Typhoon™ Turbo Blade

- 6mm Rim height
- Wet or dry cutting

Stock No.	Diameter	Arbor Size	Price
600213	5".....	7/8"-20mm-5/8" 4-Hole.....	\$20.65
600214	6".....	7/8"-20mm-5/8" 4-Hole.....	34.10



Zenesis® Turbo Blade

New turbo design features cooling holes to limit overheating and provides consistently fast and chip-free cutting.

- Quad-hole pattern for use with flush cut adapters
- Can be used for wet or dry cutting



Stock No.	Diameter	Arbor Size	Price
358031	4 1/2".....	7/8"-20mm-5/8" 4-Hole	\$23.50
358032	5".....	7/8"-20mm-5/8" 4-Hole	25.50
358033	6".....	7/8"-20mm-5/8" 4-Hole	34.00
358035	7".....	7/8"- 5/8"	38.00

ELECTROPLATED MARBLE BLADES

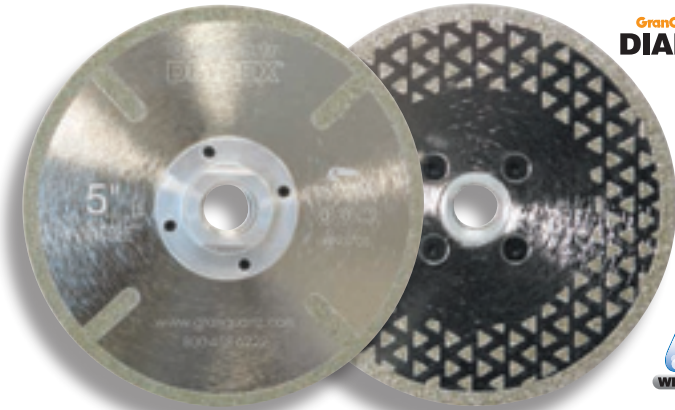

GranQuartz
DIAREX

**Diarex®
Vanity Disc**

The Diarex Vanity Disc is designed for both cutting and grinding. It is ideal for use on marble and other soft stone and can also be used for cutting engineered stone surfaces. Includes a 5/8"-11 adapter which allows convenient use for flush cutting applications.

- Combination cutting and grinding wheel
- High diamond concentration extra long life
- Use for wet or dry cutting on marble & other soft stones



Stock No.	Diam.	Arbor	Price
993705	5"	4-Hole w/5-8"-11 adapter	\$89.95



GranQuartz
Assassin

**Assassin®
Electroplated Blade**

- Exceptional value
- Use for wet or dry cutting on marble & other soft stones
- Fast, chip free cutting



Stock No.	Diam.	Arbor Size	Price
103676	4 1/2" 7/8 - 20mm - 5/8"		\$29.95
103677	5" 7/8 - 20mm - 5/8"		31.95
103678	6" 7/8 - 20mm - 5/8"		36.95



DS



**Dongsin®
Electroplated Multi-Cutter**

The Dongsin® Electroplated Multi-Cutter is designed with 10mm diamond strips for grinding with 3 extra strips on top for core protection. All-in-one cutter provides excellent cutting and grinding performance.

- 10mm Diamond Strips
- All-In-One Cutting & Grinding Applications
- Use for wet or dry cutting on marble & other soft stones

Stock No.	Diameter	Arbor	Price
122995	4 1/2" 4-Hole w/5-8"-11 adapter		\$109.95
122996	5" 4-Hole w/5-8"-11 adapter		114.95

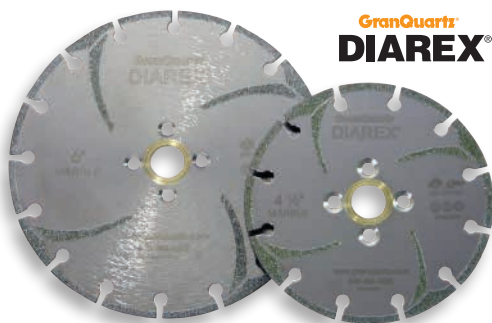

GranQuartz
DIAREX

**Diarex®
Electroplated Blade**

- Smooth cutting, long life marble blade
- "L" side protection for increased cutting speed
- Quad mount adaptor holes
- Use for wet or dry cutting on marble & other soft stones



Stock No.	Diam.	Arbor Size	Price
103673	4 1/2" 7/8 - 20mm - 5/8"		\$39.95
103674	5" 7/8 - 20mm - 5/8"		44.95
103675	6" 7/8 - 20mm - 5/8"		59.95



DS



**Dongsin® Blackbird
Electroplated Blade**

- Smooth cutting marble blade
- Use for wet or dry cutting on marble & other soft stones

Stock No.	Diam.	Arbor Size	Price
122991	4" 5/8 - 7/8"		\$41.95
122992	4 1/2" 5/8 - 7/8"		45.95
122993	5" 5/8 - 7/8"		49.95
122994	7" 5/8 - \diamond		89.95



GranQuartz
Pro Series



**Pro Series®
Electroplated Blade**

The best performance for electroplated blades.

- Use for wet or dry cutting on marble & other soft stones

Stock No.	Diameter	Arbor Size	Price
118271	4" 7/8 - 20mm - 5/8"		\$27.10
118272	4 1/2" 7/8 - 20mm - 5/8"		28.75
118273	5" 7/8 - 20mm - 5/8"		32.35
118274	6" 7/8 - 20mm - 5/8"		47.00
118275	7" 7/8 - \diamond - 5/8"		62.65

PEARL



**Pearl® P5™
Electroplated Marble Blade**

- High diamond concentration for extra long life
- Advanced electroplated bond for fast, clean chip-free cutting
- For wet or dry cutting of Marble & other softer stone

Stock No.	Diameter	Arbor Size	Price
697354	4"	20mm - 5/8"	\$67.95
697355	4 1/2"	7/8" - 5/8"	74.70
697356	5"	7/8" - 5/8"	83.55
697357	7"	5/8" - 	119.95

Keep it Cool! Even though many diamond tools are dry cutting, it is still important to not let the blade or core bit get too hot. Heat is the #1 enemy of diamond tools.

PEARL



**Pearl® P4™
Electroplated Marble Blade**

- Extra long life
- Advanced electroplated bond for fast, clean chip-free cut
- Ideal for cutting marble and travertine
- For wet or dry cutting of marble & other softer stone

Stock No.	Diameter	Arbor Size	Price
600310	4"	7/8" - 20mm - 5/8"	\$44.95
600311	4 1/2"	7/8" - 20mm	49.99
600312	5"	7/8" - 5/8"	58.45
600313	7"	5/8" - 	80.40



**Cyclone®
Electroplated Marble Blade**

Cyclone marble blades are specially designed to cut all types of marble faster and cleaner than anything on the market today at a mid-range price!

- For wet or dry cutting of marble & other softer stone

Stock No.	Diam.	Arbor Size	Price
115980	4"	7/8" - 20mm - 5/8"	\$32.35
115981	4 1/2"	7/8" - 20mm - 5/8"	33.95
115982	5"	7/8" - 20mm - 5/8"	37.00
115983	7"	7/8" -  - 5/8"	65.95

CYCLONE



**Super Cyclone®
Electroplated Marble Blade**

Smooth cutting electroplated blade with side protection.

- For wet or dry cutting of Marble & other softer stone

Stock No.	Diam.	Arbor Size	Price
600494	4 1/2"	7/8" - 20mm - 5/8"	\$39.95
600495	5"	7/8" - 20mm - 5/8"	42.95
600496	6"	7/8" - 20mm - 5/8"	62.95

ALPHA



Alpha® Libero Blades

- For wet or dry cutting of Marble & other softer stone

Stock No.	Diam.	Arbor Size	Price
115994	4"	20mm - 5/8"	\$63.14
115996	4 1/2"	7/8" - 20mm - 5/8"	70.43
115993	5"	7/8" - 20mm - 5/8"	84.85
115999	7"	5/8" w/ 	115.05

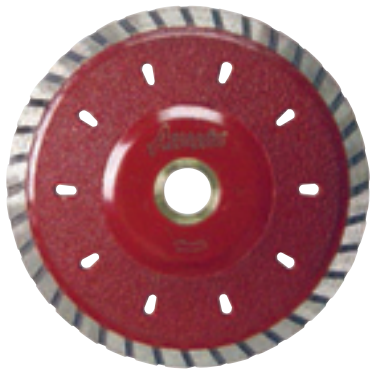

GranQuartz
Assassin



Assassin® Contour Cutting Blade

- Vacuum brazed side protection on both sides
- Fast, smooth cutting with minimal chipping
- Wet or dry cutting

Stock No.	Diameter	Arbor Size	Price
993183	4 1/2"	7/8 - 20mm - 5/8"	\$85.95
993185	5"	7/8 - 20mm - 5/8"	89.95
993189	6"	7/8 - 20mm - 5/8"	95.95



GranQuartz
RECON



Recon® Contour Cutting Blade

- Thin kerf, turbo rim design for fast cutting
- Diamond segments embedded throughout the core for maximum protection
- Wet or dry cutting

Stock No.	Diameter	Arbor Size	Price
993783	5"	7/8 - 20mm - 5/8"	\$95.95



Rival® Contour Cutting Blade

- Thin kerf, turbo rim design for fast cutting
- Side cutting segments for smooth cut
- Wet or dry cutting

Stock No.	Diameter	Arbor Size	Price
359266	5"	7/8 - 20mm - 5/8"	\$96.50



GranQuartz
Pro Series



Pro Series® Contour Cutting Blade

Pro Series Contour blades are the industry leader for sink & curved cuts, utilizing diamond layered slide slots for increased performance.

- For curved cutting applications
- Wet or dry cutting

Stock No.	Diameter	Arbor Size	Price
800334	4 1/2"	7/8 - 20mm - 5/8"	\$104.45
800339	5"	7/8 - 20mm - 5/8"	114.95



ALPHA



Alpha® Contour Cutting Blade

Alpha's contour blade is designed with diamonds on the convex side for high performance cutting of sink holes & other curved cutting applications.

- Wet or dry cutting

Stock No.	Diameter	Arbor Size	Price
116095	4"	20mm	\$143.33
116096	4 1/2"	7/8"	140.46
116097	5"	7/8"	148.42

GranQuartz
DIAREX®

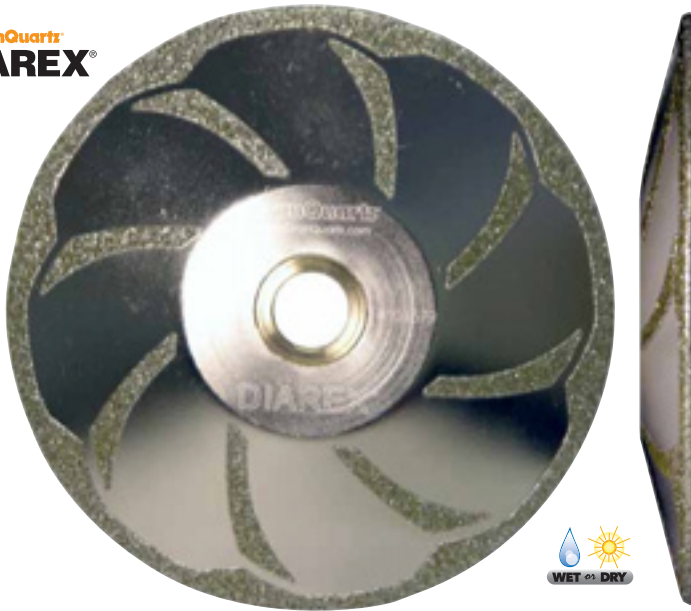

**Diarex®
Electroplated
Contour Cutting Blade**

- For curved cutting applications and for cutting sink holes in marble and other softer stone
- Electroplated diamond protection on both sides
- 5" Diameter
- Use for wet or dry cutting

Stock No.	Diameter	Arbor Size	Price
103679	5"	7/8"-20mm -5/8"	\$99.95



CYCLONE



**Cyclone®
Contour Cutting Blade**

Cyclone's turbo design cuts with a smoother, cleaner cut than a segmented blade. Diamond slots on the outside ensure easy and uninterrupted passage through the stone.

- Wet or dry cutting

Stock No.	Diam.	Arbor Size	Price
600259	5" 7/8" -20mm -5/8".....		\$114.95
600240	6" 7/8" -20mm -5/8".....		139.95

CYCLONE



**Hurricane®
Contour Cutting Blade**

Quick, smooth cutting performance at an excellent value.

- Turbo Rim design
- Two-sided drop segment for core protection

Stock No.	Diam.	Arbor Size	Price
600490	5" 7/8" -20mm -5/8".....		\$84.95
600491	6" 7/8" -20mm -5/8".....		104.95

CYCLONE

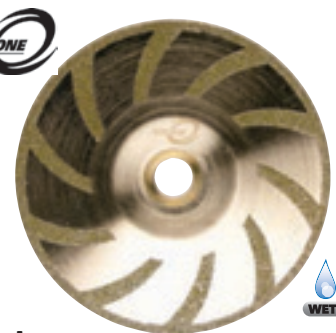

**Cyclone®
Electroplated
Contour Cutting Blade**

Designed for curved cutting applications in marble.

- Electroplated core protection
- 5" Diameter
- Wet or dry cutting

Stock No.	Arbor Size	Price
600492	7/8" - 20mm - 5/8"	\$109.95

PEARL



**Pearl® P5™
Contourcut™ Blade**

- High diamond concentration for extra long life
- Designed with core protection
- Cuts circles and ovals quickly and efficiently
- Wet or dry cutting

Stock No.	Diameter	Arbor Size	Price
115761	4" 5/8".....		\$132.95
115770	5" 7/8" - 5/8".....		181.95
115762	6" 5/8" - ◊.....		194.95
170926	7" 5/8" - ◊.....		197.95

ALPHA



**Alpha®
Contour Cutting Marble Blade**

The Alpha® Contour Blade for Marble is designed specifically for cutting marble and limestone sinkholes and other curve cutting applications.

- Great for Marble and Limestone
- Cuts clean curves with a wider kerf
- 5" Diameter
- Wet or dry cutting

Stock No.	Diameter	Arbor Size	Price
116259	5" 5/8".....		\$149.51



Alpha® Trim Master Blade

Dry cutting blade for miter saws.

- Wet or dry cutting

Stock No.	Diameter	Arbor Size	Price
900211	10"	5/8"	\$135.57
900219	12"	1" - 5/8"	188.53



Alpha® Knock Out Rail Saw Blade

- Designed for rail saws
- Excellent choice for the Trac-Star 2000 saw
- Wet or dry cutting

Stock No.	Diameter	Arbor	Price
116085	8"	5/8" -	\$101.61



Alpha® Vortex Dry Cut Blade

- For dry cutting & grinding applications
- Make straight cuts and grind bullnose edges
- Wet or dry cutting

Stock No.	Diameter	Arbor Size	Price
900090	4"	20mm - Quad Drive ...	\$89.16
900091	5"	20mm - Quad Drive ...	108.61



Alpha® Katana Dry Cut Blade

Designed for dry cutting granite, marble, porcelain and engineered stone.

- Wet or dry cutting

Stock No.	Diameter	Arbor Size	Price
116211	4" 1/2"	7/8" - 20mm	\$46.16
116212	5"	7/8" - 20mm	52.49



Alpha® Q-Cut

- For cutting hard tile surfaces including Quartzite and Granite
- Designed for fast, precision chip-free cutting

Stock No.	Diam.	Arbor Size	Price
116926	5"	7/8"	\$41.26
116927	6"	5/8"	52.07
116930	10"	5/8"	108.83



Pearl® P3™ Marble Blade

- Long life
- Thin turbo rim and core for fast, clean and chip-free cutting
- Ideal for cutting marble and tile
- Wet or dry cutting

Stock No.	Diameter	Arbor Size	Price
694699	4"	20mm	\$27.25
694700	4 1/2"	7/8 - 5/8"	29.20
694701	7"	5/8"	50.50



STANDARD



FLUSH-CUT



Pro Series® UCS Turbo Blade



The Pro Series UCS blade is unlike any blade in the market. With a thin kerf, special matrix, diamond grit size, and electroplating on the cutting side of the rim, the Pro Series UCS is a truly universal cutting blade. Testing has shown it will work great on UCS material, quartzite, granite, and engineered stone.

• Available in standard Quad or full face Flush Mount for finish cutting

QUAD

Stock No.	Diameter/Arbor	Price
602360	5", 7/8" - 20mm - 5/8", 4 Hole...	\$48.95
602361	6", 7/8" - 20mm - 5/8", 4 Hole.....	59.95

FLUSH

Stock No.	Diameter/Arbor	Price
602362	5", 5/8" - 11, Flush	\$76.95
602363	6", 5/8" - 11, Flush	96.95

TILE BLADES

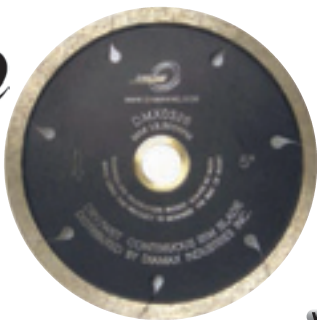

Cyclone® Continuous Rim Blade

- 4" - 5" Diameter blades: wet or dry cutting
- 7" - 12" Diameter blades: wet cutting only

Stock No.	Diameter/Use	Arbor Size	Price
620080	4" wet/dry use.....	7/8" - 20mm - 5/8"	\$21.95
620081	4 1/2" wet/dry use.....	7/8" - 20mm - 5/8"	26.95
620082	5" wet/dry use.....	7/8" - 20mm - 5/8"	28.95
620084	7" wet use.....	5/8" -	43.95
620085	8" wet use.....	7/8" - 20mm - 5/8"	51.95
620086	10" wet use.....	7/8" - 5/8"	56.95
620087	12" wet use.....	7/8" - 5/8"	77.95



Great for Finish Cuts!



Pro Series® Continuous Rim Blade

Best cutting continuous rim blade in the stone industry.

- 4" - 5" Diameter blades: wet or dry cutting
- 6" - 14" Diameter blades: wet cutting only

Stock No.	Diameter/Use	Arbor Size	Price
600364	4" wet/dry use.....	7/8" - 20mm - 5/8"	\$19.79
600365	4 1/2" wet/dry use.....	7/8" - 20mm - 5/8"	21.95
600366	5" wet/dry use.....	7/8" - 20mm - 5/8"	24.99
600369	6" wet use.....	7/8" - 20mm - 5/8"	27.10
600367	7" wet use.....	7/8" - - 5/8"	32.35
600368	10" wet use.....	1" - 5/8"	55.95
600488	12" wet use.....	1" - 5/8"	83.55
600489	14" wet use.....	50/60mm	115.95



Alpha® Sonic Tile Blades

- Extremely smooth, chip-free cutting
- 4" Diameter blade: wet or dry cutting
- 6" - 12" Diameter blades: wet cutting only

Stock No.	Diameter/Type/Use	Arbor Size	Price
116014	4" Sonic wet/dry use.....	20mm.....	\$24.32
116023	8" Sonic wet use.....	5/8".....	41.37
116003	10" Sonic wet use.....	5/8".....	55.42
115997	12" Sonic wet use.....	1".....	85.14



Pearl® P2™ Pro V™ Tile Blades

- 10mm rim height
- Economical price
- Continuous rim for clean chip-free cutting
- 4" and 4 1/2" Diameter blades: wet or dry cutting
- 7" - 10" Diameter blades: wet cutting only

Stock No.	Diameter/Use	Arbor Size	Price
569306	4" wet/dry.....	5/8"-20mm.....	\$8.35
569307	4 1/2" wet/dry.....	7/8"-20mm-5/8".....	9.95
569308	7" wet use.....	7/8"-5/8".....	19.89
569309	8" wet use.....	5/8"-20mm.....	29.25
569310	10" wet use.....	5/8"-20mm.....	36.60



Zenesis® Continuous Rim Blades

- For cutting porcelain, granite and other hard materials
- Continuous rim for clean chip-free cutting
- 4 1/2", 5" and 6" Diameter blades: use for wet or dry cutting
- 7" and 10" Diameter blades: wet cutting only

Stock No.	Diameter/Use	Arbor Size	Price
370125	4", wet/dry.....	5/8"-20mm.....	\$18.50
370126	4 1/2", wet/dry.....	5/8"-20mm.....	19.50
370127	5", wet/dry.....	7/8"-5/8".....	22.50
370128	6", wet/dry.....	5/8"-20mm.....	28.00
370129	7", wet.....	5/8" -	33.00
370130	8" wet.....	1" - 5/8"	35.00
370131	8" wet.....	5/8" -	35.00
370132	10", wet.....	5/8"-20mm.....	54.50

PORCELAIN BLADES



Cyclone® Mesh Thin Turbo Blade

- New dimple rim design reduces heat from friction
- Cooler rim increases life and cutting speed
- Wet or dry cutting

Stock No.	Diam.	Arbor Size	Price
950166	4".....	5/8"-20mm-7/8".....	\$26.95
950167	4 1/2".....	5/8"-20mm-7/8".....	28.95
950168	5".....	5/8"-20mm-7/8".....	33.95
950169	10".....	5/8"-20mm-7/8".....	65.95
050458	14".....	50/60mm.....	139.95



Cyclone® Ultra Mesh Black Turbo Blade

Designed for use on Ultra Compact surfaces, granite, engineered stone and quartzite at fast speeds with minimal chipping and clean cuts.

- For wet or dry cutting
- Ultra thin rim with turbo mesh design
- Reinforced hub for consistent, straight cutting

Stock No.	Diam.	Arbor Size	Price
950137	4 1/2"	5/8"-20mm-7/8"	\$34.95
950138	5"	5/8"-20mm-7/8"	37.95
950139	6"	5/8"-20mm-7/8"	39.95



ProSeries® Thin Cut Turbo Blade

- Wet or dry cutting
- Cuts porcelain and granite chip-free and faster than continuous rim tile blades.

Stock No.	Diam.	Arbor Size	Price
600180	4"	7/8" - 20mm - 5/8"	\$20.65
600181	4 1/2"	7/8" - 20mm - 5/8"	25.80
600182	5"	7/8" - 20mm - 5/8"	28.95
600183	7"	7/8" - \diamond - 5/8"	44.45



Alpha® Porcellana

- 10mm Rim height
- Continuous rim
- Designed for dense Granite, Marble, and Porcelain
- Wet cutting only

Stock No.	Diameter	Arbor Size	Price
900087	4 3/8"	7/8"-20mm	\$33.68
900088	5"	7/8"	41.70
900089	8"	5/8"	87.62
118187	10"	5/8"	103.14



Turbo-mesh rim

Pearl® Mesh Thin Turbo Blade

- Turbo-mesh rim design with thin core for fast cutting and minimal chipping
- Blade cuts cool with increased life and cutting speed
- Wet or dry cutting
- 10mm rim height

Stock No.	Diam.	Arbor Size	Price
920672	4"	5/8"-20mm-7/8"	\$28.55
920673	4 1/2"	5/8"-20mm-7/8"	32.45
920674	5"	5/8"-20mm-7/8"	36.25
920665	6"	5/8"-20mm-7/8" 4-Hole	48.95
920675	7"	5/8" - \diamond - 7/8"	54.95
920676	10"	5/8"-20mm-7/8"	65.95
920677	14"	50/60mm	149.95



Pearl® P2™ Pro V Porcelain Blade®

- 8mm Rim height
- Economical price
- Designed with slots for a fast, cool and chip-free cut
- 4" & 4 1/2" Diameter blades: wet or dry cutting
- 7" - 10" Diameter blades: wet cutting only

Stock No.	Diameter/Use	Arbor Size	Price
990169	4" wet/dry use	20mm - 5/8"	\$13.09
990170	4 1/2" wet/dry use	7/8" - 5/8"	15.19
990171	7" wet use	5/8"	28.15
990172	8" wet use	5/8"	31.50
990173	10" wet use	5/8"	44.95

PEARL



Pearl® P4™ Porcelain Blade

- 8mm Rim height
- With slots for fast, cool and chip-free cutting
- 4" & 4 1/2" Diameter blades: wet or dry cutting
- Extra long life
- 7" - 10" Diameter blades: wet cutting only

Stock No.	Diameter/Use	Arbor Size	Price
990174	4" wet/dry use.....	5/8"	\$31.30
990175	4 1/2" wet/dry use.....	5/8"	35.50
698870	7" wet use.....	5/8"	54.55
698871	8" wet use.....	5/8"	59.95
695225	10" wet use.....	5/8"	78.70



PEARL



Pearl® P5™ Porcelain Blade

- 9mm Rim height
- High diamond concentration for extra long life
- Continuous rim for clean and chip-free cut
- Wet cutting only

Stock No.	Diameter/Use	Arbor Size	Price
990176	4" wet use	5/8"	\$35.50
695217	7" wet use	5/8"	51.40
695219	8" wet use	5/8"	71.35
695224	10" wet use	5/8"	94.45



GLASS BLADES

PEARL



Pearl® P2™ Pro V Glass Blade

- 7mm Rim height
- Economical price
- Engineered with an advanced bond
- Wet cutting

Stock No.	Diameter	Arbor	Price
990153	7"	5/8"	\$52.20
990154	8"	5/8"	55.35
990155	10"	5/8"	61.60



ALPHA



Alpha® Vetro Glass Blade

- Premium wet cutting blade for glass, with a continuous diamond rim and bond hardness for clean, smooth cuts with minimal chipping.
- Wet cutting only
 - Minimal chipping when wet cutting glass

Stock No.	Diam./Use	Arbor Size	Price
116029	4 3/8" wet use.....	7/8"-20mm.....	\$31.83
900081	7" wet use.....	5/8"	67.55
170075	8" wet use.....	5/8"	80.28
900086	10" wet use.....	5/8"	93.27



PEARL



Pearl® P5™ Glass Blade

- 7mm Rim height
- High diamond concentration for extra long life
- Engineered with an advanced bond
- Wet cutting

Stock No.	Diameter	Arbor	Price
695223	10"	5/8"	\$99.95



TUCK POINT/RODDING BLADES



ProSeries® Turbo Tuck Point Blade

Designed for cutting channels for reinforcement rods in granite, marble and other natural stone.

- 3/16" Thick diamond rim
- Ideal for use on circular saws or angle grinders
- Wet or dry cutting

Stock No.	Diam.	Arbor	Price
993615	4"	5/8"-7/8"	\$74.95
993616	5"	5/8"-7/8"	79.95
993617	7"	5/8"-◇-7/8"	99.95



Pearl® P2™ Tuck Point Blade

- 10mm Thick diamond rim
- Engineered for repairing grout
- Designed to clean mortar joints quickly and easily
- Wet or dry cutting

Stock No.	Diameter/ Blade Thickness	Arbor	Price
677760	4" x 1/4"	7/8 - 5/8"	\$25.95
677761	4 1/2" x 1/4"	7/8 - 5/8"	27.95
677762	7" x 1/4"	7/8- ◇ - 5/8"	43.95



Alpha® Hot Rod

Ideal for channel cutting when using steel reinforcement rods, quick cutting diamond grit and matrix suited for all granites.

- 3" Diameter
- Arbor: 7/8" - 20mm
- 15,000 Max. RPM
- Wet or dry cutting

Stock No.	Application	Segments	Price
620021	Granite	1/4"	\$94.96
620023	Granite	1/8"	94.96
620024	Granite	3/8"	108.30

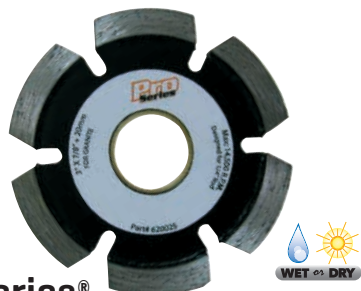

ProSeries® Rodding Blade

Industry's best performing standard rodding blade. Great for cleaning mortar and grout areas.

- Wet or dry cutting

Stock No.	Size	Arbor	Price
620025	3" x 1/4"	7/8"-5/8"	\$62.65
620029	3" x 1/8"	7/8"-20mm	52.20
620030	5" x 1/4"	7/8"-5/8"	72.95
620031	5" x 1/8"	7/8"-5/8"	62.95
620032	7" x 1/4"	7/8"- ◇ -5/8"	93.95
620033	7" x 1/8"	7/8"- ◇ -5/8"	83.95

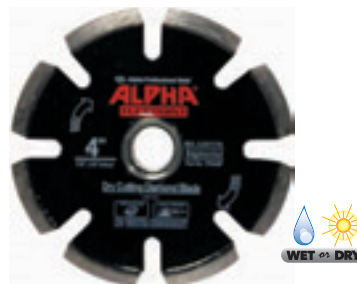

Alpha® Tuck Point Wheels

Very aggressive and long lasting, these dry cutting wheels fit 4 and 7 inch grinders. Masons and brick re-pointers will find this wheel extremely useful for working mortar and soft stone.

- 6mm Thick diamond rim
- 13,700 Max. RPM
- Wet or dry cutting

Stock No.	Diameter/ Blade Thickness	Arbor	Price
116071	4" x 1/4"	7/8"-5/8"	\$71.70



Legend® Premium Rodding Blade

High performance rodding blade for those who require maximum performance.

- 1/4" Thickness
- Great for granite rodding applications
- Wet or dry cutting

Stock No.	Size	Arbor	Price
696445	4"	7/8" - 5/8"	\$62.70
696446	4 1/2"	7/8" - 5/8"	67.95
696447	5"	7/8" - 5/8"	85.70
696448	7"	5/8" -	104.50



Pearl® P2 PRO-V™ Segmented Blades

- .080 Thickness
- 10mm Rim height

• Wet or dry cutting

Stock No.	Size	Arbor	Price
569291	4"	5/8"-20mm	\$9.95
569292	4 1/2"	7/8"-20mm-5/8"	12.00
569293	5"	7/8"-20mm-5/8"	15.39
569294	7"	7/8" -	20.55
699200	10"	7/8"-20mm-5/8"	39.05



Recon® Segmented Blade

- 8.5mm Rim height
- Medium bond for use on many types of hard materials
- Wet or dry cutting

Stock No.	Size	Arbor	Price
993554	4"	7/8-20mm-5/8"	\$10.95
993555	4 1/2"	7/8-20mm-5/8"	11.95
993556	5"	7/8-20mm-5/8"	13.95
993557	7"	7/8 -	19.95



HydroQuad™ Adapters

Use with any center water fed grinder and turbo blade with the HydroQuad™ flush-mount adapter to eliminate dust. The HydroQuad™ directs water towards the work, flushing out the cut line for faster, cleaner cutting. HydroQuad™ washer converts your existing standard quad adapter to a HydroQuad™. Patent applied for.

Stock No.	Description	Price
115911	Brass, 8-hole 5/8"-11 thread for 20mm Arbor	\$41.55
115720	Brass, 4-hole HydroQuad™ Washer	11.80



Diarex® Flush-Mount Threaded Flanges

- 4-hole brass flange for use on 4" - 7" blades and cup wheels
- 8-hole steel flange for use on 8" - 12" blades when used on angle grinders

Stock No.	Description	Price
115786	Brass, 4-hole 5/8"-11 thread for 20mm arbor	\$24.50
170326	Stainlesssteel, 4-hole 5/8"-11 thread for 22.2mm arbor	30.15
115774	Brass, 4-hole M-14 thread for 22.2mm (7/8") arbor	21.80

Call GranQuartz® For The Best Selection of Diamond Blades In The Stone Industry!

We have the perfect bridge saw blade for your specific cutting requirements.

Choose The Correct Diameter Blade Based On The RPM On Your Bridge Saw.

Diameter	Marble RPM	Granite RPM
12"	2,200-2,500	1,800-2,000
14"	1,800-2,000	1,600-1,800
16"	1,600-1,800	1,400-1,500
18"	1,400-1,500	1,200-1,300
20"	1,200-1,300	1,100-1,200
24"	1,000-1,100	900-1,000

Always Begin Cutting At The Lowest Feed Speed and Increase Feed Based Off Load On Your Saw.

Diam.	Quartzite/ Granite RPM	Quartzite Feed	Medium Granite Feed	Hard Granite Feed
12"	1,900-2,100	1-3'	5-12'	5-10'
14"	1,650-1,800	1-3'	5-12'	5-10'
16"	1,450-1,600	1-3'	5-12'	5-10'
18"	1,300-1,400	1-3'	5-12'	5-10'
20"	1,200-1,300	1-3'	5-12'	5-10'
24"	900-1,000	1-3"	5-12'	5-10'

Diam.	Marble RPM	Marble Feed
12"	2,200-2,500	5-9'
14"	1,800-2,000	5-9'
16"	1,600-1,800	5-9'
18"	1,400-1,500	5-9'
20"	1,200-1,300	5-9'
24"	1,000-1,100	5-9'



PEARL P5 REACTOR

Cutting Speed	●●●●●
Blade Life	●●●●●
Clean Cutting	●●●●●



PEARL P5 SHADOW

Cutting Speed	●●●●●
Blade Life	●●●●●
Clean Cutting	●●●●●



DIAREX MACHETE

Cutting Speed	●●●●●
Blade Life	●●●●●
Clean Cutting	●●●●●



GRANQUARTZ LEGEND CERBERUS

Cutting Speed	●●●●●
Blade Life	●●●●●
Clean Cutting	●●●●●



Recon Combat™ Silent Core Blade

- 20mm Tall Diamond Segments.
- High Diamond Concentration.
- Special Matrix Eliminating the Need for re-dressing.
- 50/60mm Arbor

Stock No.	Diam.	Arbor	Price
695952	14"50/60mm.....	\$224.00
695971	16"50/60mm.....	273.00

Cutting Speed	●●●●●
Blade Life	●●●●●
Clean Cutting	●●●●●



Legend® Cerberus Blade

The Legend Cerberus is a beast of it's own, with a 25mm segment with high diamond concentration for extremely long life and high quality cutting of granite, engineered stone and other natural stone materials. Best performance will be on saws of 15 Hp or higher, great on Robo-Cut saws.

- 25mm Tall Segments
- 50/60 mm Arbor

Stock No.	Diameter	Arbor	Price
490190	12"	50/60	\$245.00
490191	14"	50/60	299.00
490192	16"	50/60	345.00
490193	18"	50/60	435.00

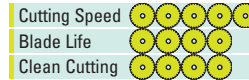

25mm Segment

GranQuartz
DIAREX®



Diarex® Machete Blade

Pattern diamond and segment layering technology for faster cutting speeds on granite, engineered stone and other natural stone materials. Very quiet, clean and consistent cutting.

- 25mm Tall Segments
- 50/60 mm Arbor

Stock No.	Diameter	Arbor	Price
490054	12"	50/60	\$259.50
490055	14"	50/60	327.50
490155	14"	50/60 Combi Cut...	368.00
490056	16"	50/60	390.50
490064	16"	50/60 Combi Cut...	429.00
490057	18"	50/60	466.50
490058	20"	50/60	582.00
490087	24"	50/60	865.00

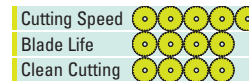

Unique Segment Layering and Pattern Diamond Technology

PEARL



Pearl® P5™ REACTOR™ PRO Silent Core Blade

Engineered with ADM™ (Advance Diamond Matrix) diamond pattern and layering technology.

- 25mm segments
- High diamond concentration for extra long life
- 50/60mm Arbor

Stock No.	Diameter	Arbor	Price
698220	14"	50/60	\$320.00
698221	16"	50/60	382.00
698223	18"	50/60	457.00



High Diamond Concentration

PEARL



High Diamond Concentration

Pearl® P4™ REACTOR™ PRO Silent Core Blade

Engineered with ADM™ (Advance Diamond Matrix) diamond pattern and layering technology for precision cutting.

- 18mm segments
- Extra long life
- 50/60 Arbor

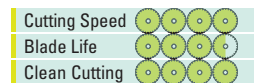

Stock No.	Diameter	Price
600359	12"	\$235.00
600354	14"	266.00
600355	16"	328.00
600358	18"	359.00

PEARL



Pattern Diamond Technology

Pearl® P5™ Shadow™ Bridge Saw Blade

- 25mm Tall Segments
- Pattern Diamond Technology
- Very Fast Cutting
- 50/60mm Arbor
- Consistent Cutting Performance

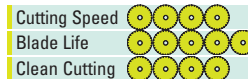

Stock No.	Diam.	Arbor	Price
990123	12"	...50/60mm	\$278.00
990124	14"	...50/60mm	329.50
999124	14"	...50/60Combi Cut	379.95
990125	16"	...50/60mm	391.50
990126	18"	...50/60mm	473.50

GranQuartz Pro Series



Pattern Diamond Technology

Pro Series® Bridge Saw Blade

Special bond formulation makes the Pro Series blade ideal for use on medium to high horsepower saws.

- Wet cutting only
- Pattern Diamond Technology

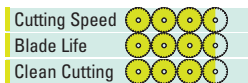

Stock No.	Diam.	Arbor	Price
490062	14"	...50/60mm	\$259.95
490065	16"	...50/60	309.95
490067	18"	...50/60mm	329.95

**DIAREX®
BLACK
MAGIC
2.0**



Diarex® Black Magic 2.0 Granite Blade

Black Magic 2.0 has a new, upgraded segment formula to produce clean, chip-free cuts on all natural stone and engineered stone surfaces.

- Excellent cutting performance
- Ultra clean cutting

Stock No.	Diam.	Arbor	Price
490142	14"	50/60mm	\$325.00
490143	16"	50/60mm	355.00
490144	18"	50/60mm	455.00

GranQuartz®
DIAREX®



Diarex® Black Magic Silent Core Granite Blade

- Legendary cutting performance
- Ultra clean cutting
- 20mm Tall segments

Stock No.	Diam.	Arbor	Price
490074	14"	50/60mm	\$318.00
490076	16"	50/60mm	349.00
490078	18"	50/60mm	450.00

Cutting Speed	●●●●●
Blade Life	●●●●●
Clean Cutting	●●●●●

GranQuartz®
Assassin



Assassin® Bridge Saw Blade

- 20mm Tall Segments
- Silent Core
- 50/60mm Arbor

Stock No.	Diam.	Arbor	Segment	Price
490015	14"	50/60mm	20mm	\$256.50
490017	16"	50/60mm	20mm	291.50
490152	18"	50/60mm	25mm	305.00

Cutting Speed	●●●●●
Blade Life	●●●●●
Clean Cutting	●●●●●

GranQuartz®
Gran Cut IIIGranQuartz®
Gran Cut III
Granite Blade

Cutting Speed	●●●●
Blade Life	●●●●
Clean Cutting	●●●●

Gran Cut III's proprietary segment design provides consistently high quality sawing performance.

- 50/60mm Arbor

Stock No.	Diam.	Arbor	Price
108938	10"	50/60mm	\$191.50
108966	12"	50/60mm	189.50
109080	14"	50/60mm	214.00
109137	16"	50/60mm	238.00
109188	18"	50/60mm	293.50
109212	20"	50/60mm	391.50

NEW!

Diasant® Pulsar Plus
Granite Blade

Diasant's aggressive, fast cutting & unique diamond pattern offer great quality and value. 25mm segment height for exceptional speed and longevity.

- 50/60mm Arbor
- Fast, chip-free cutting

Stock No.	Diam.	Arbor	Price
445105	12"	50/60mm	\$255.00
445106	14"	50/60mm	305.00
445107	16"	50/60mm	355.00
445108	18"	50/60mm	425.00
445109	20"	50/60mm	555.00

NEW!

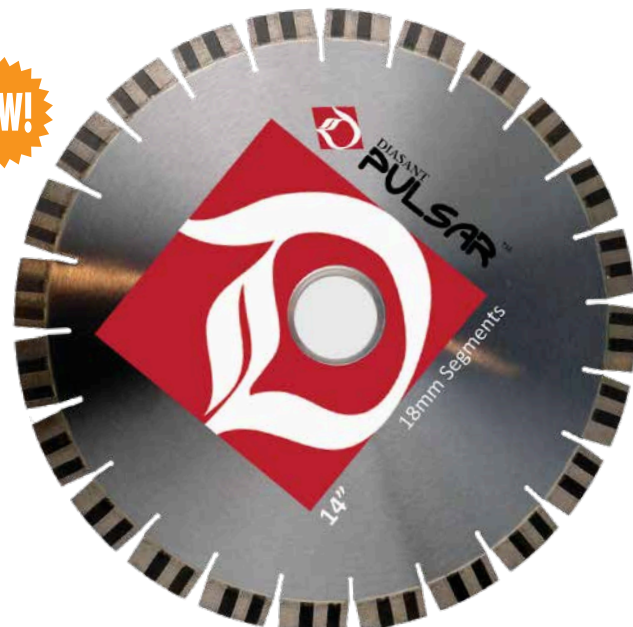
Diasant® Pulsar
Patterned Diamond Blade

Pulsar's Pattern Diamond bond provides fast, clean cutting. 18mm segment height for exceptional speed and smooth cuts.

- 50/60mm Arbor
- Excellent for fast cutting of Quartz surfaces

Stock No.	Diam.	Arbor	Price
445113	14"	50/60mm	\$266.00
445114	16"	50/60mm	328.00
445115	18"	50/60mm	359.00

WORLD BEST
BRIDGE SAW BLADES

ZENESIS™



ZENESIS™ BLACK 4
The most technologically advanced
pattern diamond bridge saw blade
available today





Zenesis® Xpert Bridge Saw Blade

Xpert patterned diamond technology provides consistently excellent cutting speed with minimal chipping from the first cut to the very last.

- 25mm segments
- High diamond concentration for extra long life
- Ultra fast, consistent cutting
- 50/60mm Arbor

Stock No.	Diameter	Price
359097	14".....	\$309.00
359099	16".....	360.50
359101	18".....	435.50



Zenesis® II Bridge Saw Blade

- Works great on high or low horsepower saws
- Great on granite & engineered stone
- Feed rate: 10-17' per minute
- For wet cutting only
- 25mm Tall Segments

Stock No.	Diam.	Arbor	Price
359037	12".....	50/60mm	\$247.00
359045	14".....	50/60mm	267.50
359035	16".....	50/60mm	319.00
359034	18".....	50/60mm	412.00
359092	20".....	50/60mm	541.00



Zenesis Black® 4 Silent Core Bridge Saw Blade

- 25mm Tall Diamond Segments
- 50/60mm Arbor
- Pattern Diamond Technology
- For Granite & Engineered Stone

Stock No.	Diam.	Arbor	Price
057573	12".....	50/60mm	\$282.00
057574	14".....	50/60mm	328.00
057575	16".....	50/60mm	381.00
057576	18".....	50/60mm	476.00
057577	20".....	50/60mm	614.50



Cyclone® Silent Core Granite Blade

Cyclone High Speed Granite Blades achieve feed rates 10'-17' per minute.

- Noise reducing core
- Pressure-Tested Segments
- 26mm Tall Segments
- Extended life
- 9 Layers of Diamond Array Technology

Stock No.	Diam.	Arbor Size	Price
052532	14"	50-60mm.....	\$319.95
052533	16"	50-60mm.....	369.95

BRIDGE SAW BLADES FOR MARBLE



Pro Series® Marble Blade

The Pro Series® Marble blade is a high quality, economical solution to the most demanding marble cutting needs.

- 7mm Tall segment
- 50/60mm arbor
- Very clean cutting
- Long life

Stock No.	Diam.	Arbor Size	Price
490129	12"	50/60mm	\$139.95
490130	14"	50/60mm	159.95
490131	16"	50/60mm	189.95
490132	18"	50/60mm	259.95



Zenesis® Marble Blade

- Designed specifically to cut marble
- Silent core, smooth chip-free cutting
- Wet cutting only

Stock No.	Diam.	Arbor	Price
359209	14"	50/60mm	\$237.00
359210	16"	50/60mm	288.50
359211	18"	50/60mm	360.50

GranQuartz
DIAREX

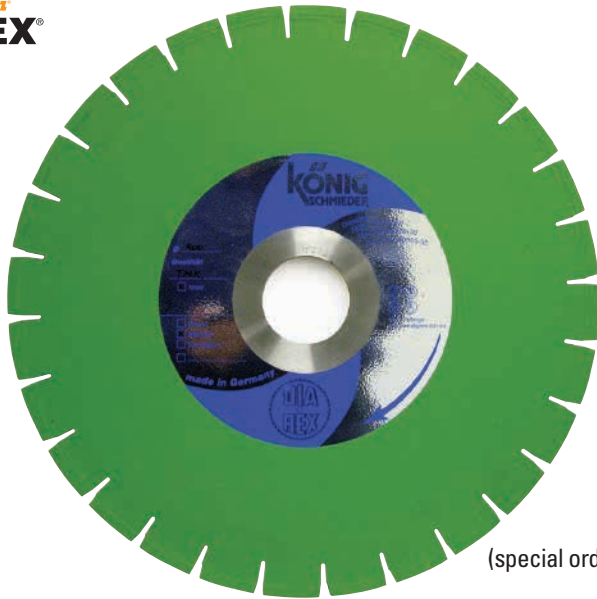

(special order item)

**Diarex®
TMK Marble Blade**

Highest quality marble blade, extremely clean cutting with long life.

- 7mm Tall segment
- Made in Germany

Stock No.	Diam.	Arbor Size	Price
057302	16"	50/60mm	\$369.00
057304	18"	50/60mm	429.95
057305	20"	50/60mm	489.95
057306	24"	50/60mm	749.95

GranQuartz



GranQuartz® Marble Blade

- Clean cut and long performance
- 8mm Tall segment

Stock No.	Diam.	Arbor Size	Price
100226	14"	60mm	\$235.00
100230	16"	60mm	292.00
100234	18"	60mm	395.00



**Disco® Blue Impulse III
Marble Blade**

- Smooth cutting and long lasting
- Soft bond, Premium Diamonds

Stock No.	Diam.	Arbor Size	Price
695288	14"	50/60mm	\$264.95
695289	16"	50/60mm	294.95
695290	18"	50/60mm	339.95

FOR LOW-HORSEPOWER SAWS



**Pro Series®
Segmented Blade**

for Blue Ripper Saw

Proprietary bond developed for 5HP Blue Ripper saws, great for high RPM rail saws.

- Long life
- 60mm arbor
- Great for cutting granite

Stock No.	Diameter	Price
600031	14"	\$206.00

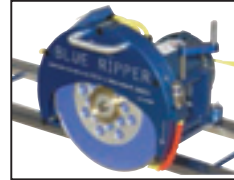

#693714
see page 224

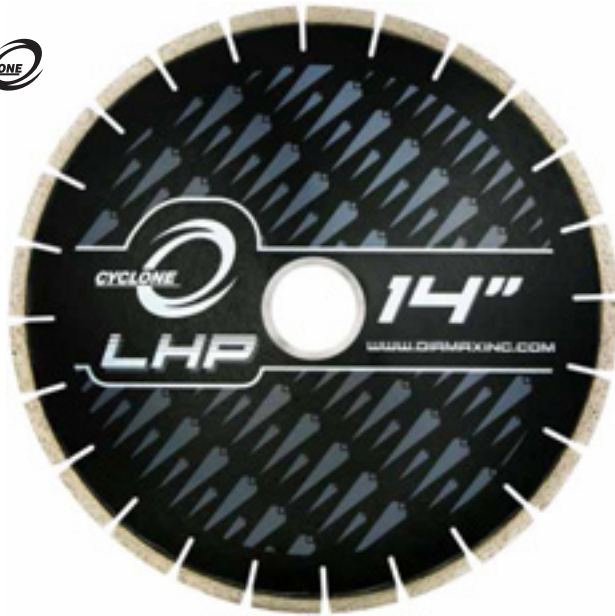

**Cyclone®
Low-Horsepower Silent Core Blade**

Designed for the Blue Ripper, Achilli TSA or similar portable track saws.

- Noise reducing core
- Special soft bond cuts super-hard material
- Excellent performance on all low horsepower saws

Stock No.	Diam.	Arbor Size	Price
052534	14"	50-60mm.....	\$195.00

PORCELAIN & GLASS BLADES

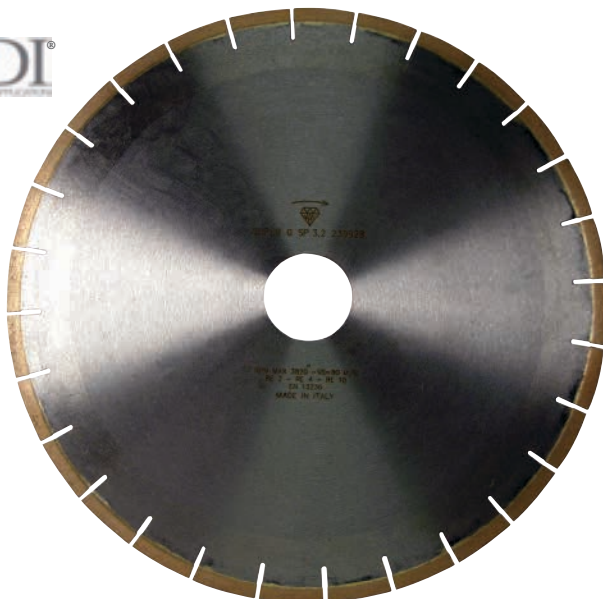

**ADI® Segmented
Porcelain &
Glass Blade**

- 10mm Tall segments
- Clean cutting of porcelain and glass
- 50/60mm Arbor

Stock No.	Diameter	Arbor	Price
926146	14".....	50/60mm	\$239.95
926147	16".....	50/60mm	279.95

PORCELAIN & GLASS BLADES

ADI



ADI® Continuous Rim Porcelain Blade

- 10mm Rim height
- Specially designed for cutting porcelain
- Ultra clean cutting
- Max depth of cut: 6mm

Stock No.	Diameter	Arbor	Price
926976	14"	60MM	\$255.00
926977	16"	60MM	299.00

GranQuartz®
DIAREX®

Diarex® Continuous Rim Blade

- For cutting granite, glass tile, porcelain and quartzite
- Pattern Diamond segment

Stock No.	Diameter	Arbor	Price
993781	14"	50/60MM	\$199.95
993782	16"	50/60MM	239.95

ALPHA®



Alpha® Silencer III Porcelain & Crystallized Glass Blade

- Clean Cutting
- Silent Core

Stock No.	Diameter	Arbor	Price
116353	12"	1"	\$322.75
116228	14"	50/60mm	351.95
116354	16"	50/60mm	439.95



FOR MITER CUTTING

GranQuartz



GST Miter Blade

- 15mm tall segment
- 50/60mm Arbor
- Specifically designed for cutting precision miters

Stock No.	Diameter	Price
057314	14"	\$359.00
057308	16"	432.00
057309	18"	538.00

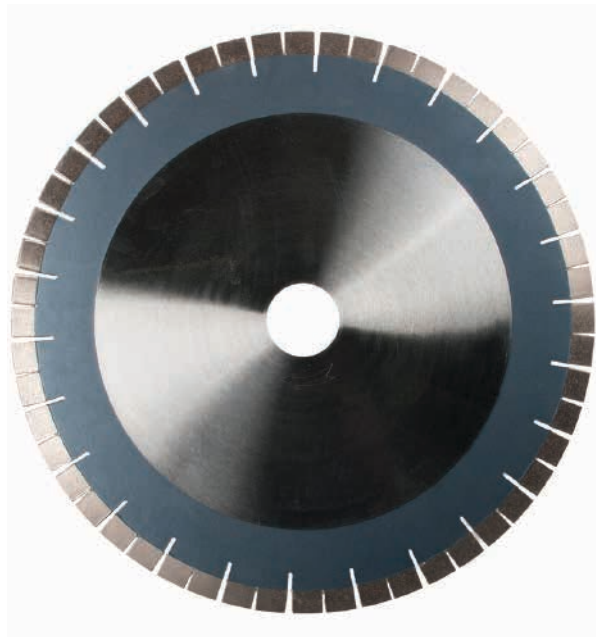

Diarex® Reinforced Miter Blade

Proprietary diamond formula layer for straight cutting & slower feed rates for mitering prevents glazing.

- 20mm tall segment
- 50/60mm Arbor
- Reinforced Core for cutting miters
- Also great for straight cutting

Stock No.	Diameter	Price
057320	16"	\$456.00
057321	18"	545.00



König® Razor Miter Blade

Two sizes available to fit multiple types of miter saws.

- Wet Cutting
- Enhanced bond for Granite and Engineered Stone
- Sizes: 350MM/40MM Arbor for MS45, 350MM/60MM Arbor for FARNESE

Stock No.	Diameter/Arbor	Price
057315	350mm, 60mm Arbor	\$269.95
057316	350mm, 40mm Arbor	299.95

QUARTZITE CUTTING



Machete for Quartzite

Segment layering technology and a special bond formulation for cutting Quartzite produces a chip free edge on mitered and straight cuts.

- 25mm segment
- Pattern Diamond Technology
- Special bond formulation for Quartzite

Stock No.	Diam.	Arbor	Price
490145	12"	50/60MM	\$232.00
490146	14"	50/60MM	283.50
490147	16"	50/60MM	349.00
490148	18"	50/60MM	438.00
490149	20"	50/60MM	510.00



Layered Bond Formula Segment Smoothly Cuts Quartzite Surfaces!

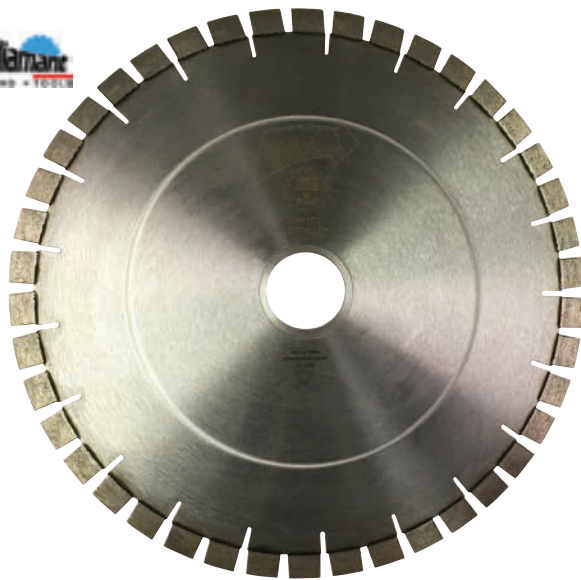

Italdiamant® Quartzite Silent or Steel Core Bridge Saw Blade

Italdiamant Quartzite blades are available as a silent core blade for making straight cuts in Quartzite, or as a steel core blade that is more robust and will handle miter cuts with little deflection.

- 50/60mm Arbor
- Silent Core or Steel Core

Stock No.	Diam./Type	Arbor	Price
050357	14", Miter/Straight.....	50/60MM	\$240.75
050358	16", Miter/Straight.....	50/60MM	285.50
050359	14", Straight Cut	50/60MM	267.50
050360	16", Straight Cut	50/60MM	305.00

QUARTZITE CUTTING



Legend® Cerberus Quartzite Bridge Saw Blades

The Legend Cerberus Quartzite blade features a V style 20mm segment with high diamond content and a special bond specifically for cutting Quartzite.

- V style segment Design
- High Concentration Pattern Diamond
- Special Bond specifically for Quartzite

Stock No.	Diam.	Arbor	Price
490195	14"	60MM	\$265.00
490196	16"	60MM	329.00
490197	18"	60MM	410.00



QUARTZITE CUTTING

ALPHA®



Alpha® Silencer III for Quartzite

Alpha Silencer III blades are specially formulated for cutting Quartzite.

- Wet cutting only

Stock No.	Diam.	Arbor	Price
052552	14".....	50/60MM\$413.25
052553	16".....	50/60MM513.05
052554	18".....	50/60MM608.25



Zenesis® for Quartzite

Zenesis blades are specially formulated for cutting Quartzite.

- Wet cutting only

Stock No.	Diam.	Arbor	Price
057544	12".....	50/60MM\$222.50
057545	14".....	50/60MM267.50
057546	16".....	50/60MM334.50
057547	18".....	50/60MM420.00
057548	20".....	50/60MM490.00



Cyclone® S/QZT Quartzite Silent or Steel Core

Ideal for use on all high performance bridge saws. Available as a silent core blade for straight cutting or as a steel core blade specially formulated for miter cutting.

- Silent core or Steel Core
- NEW softer segment design for hard stone surfaces like Quartzite
- 20mm segment height

SILENT CORE				STEEL CORE			
Stock No.	Diam.	Arbor	Price	Stock No.	Diam.	Arbor	Price
052248	14" ...	50/60MM	...\$299.75	620091	14".....	50/60MM\$329.95
052249	16" ...	50/60MM330.50	620092	16" ...	50/60MM364.95
052252	18" ...	50/60MM380.95	620093	18" ...	50/60MM428.25
				620099	20" ...	50/60MM565.00

QUARTZITE CUTTING

NEW!



Weha® White Lion Quartzite Blade

Weha's White Lion blade is excellent for cutting granite, engineered stone and quartzite materials. German made silent core runs quietly and smoothly and the Arrix (Array diamond layering) segment technology allows consistent, high speed performance.

- 50/60mm Arbor
- Fast, chip-free cutting
- 20mm Segment height

Stock No.	Diam.	Arbor	Price
444941	14"	50/60mm	\$288.75
444942	16"	50/60mm	314.15
444943	18"	50/60mm	376.35

ALPHA®



UCS
Ultra Compact Surfaces

Alpha® Silencer III J-Slot Segment Bridge Saw Blade

Alpha Silencer III blades are specially formulated for cutting UCS.

- Great for Ultra Compact Surfaces
- Wet cutting only
- J-Slot Segment design keeps blade cool

Stock No.	Diam.	Arbor	Price
052548	12"	50/60MM	\$385.35
052549	14"	50/60MM	426.28
052550	16"	50/60MM	526.85
052551	18"	50/60MM	629.35



UCS
Ultra Compact Surfaces

König® UCS Speed

High quality German made blade designed for cutting ultra compact surfaces. The reinforced steel core is great for making miter cuts.

- 10mm tall segment
- 60/50mm Arbor
- Ultra clean cut
- Fast Cutting

Stock No.	Diameter	Price
057384	14"	\$345.00
057385	16"	377.72
057386	18"	415.00

Blade Diameter Speeds:

Blade Diameter	RPM
12"	2,200-2,500
14"	1,900-2,200
16"	1,700-1,900
18"	1,500-1,700

Recommended Parameters:

Slab Thickness	Feed Speed	Speed At Exit	Plunge Speed	Miter (45°) Cutting Speed
8mm	40"/Min.	20"/Min.	8"/Min.	20"/Min.
12mm	35"/Min.	16"/Min.	8"/Min.	20"/Min.
20mm	30"/Min.	10"/Min.	8"/Min.	16"/Min.



NEW!

**Italdiamant®
Dekton Plus
Bridge Saw Blade**

Italdiamant Dekton Plus blades are recommended for cutting Dekton between 8mm and 20mm thickness. The Dekton Plus blade provides 15% longer life and can be used for miter or straight cuts.

- 50/60mm Arbor
- Silent Core or Steel Core

Stock No.	Diam./Type	Arbor	Price
050378	14", Miter/Straight.....	50/60MM	\$235.00
050379	16", Miter/Straight.....	50/60MM	269.00



NEW!

**Italdiamant® Dekton
DKT3CM
Bridge Saw Blade**

Italdiamant Dekton DKT3CM bridge saw blades are recommended for cutting 3CM thick Dekton. The Dekton DKT3CM blade can be used for Miter and Straight cuts.

- 50/60mm Arbor
- Silent Core or Steel Core

Stock No.	Diam./Type	Arbor	Price
050380	14", Miter/Straight.....	50/60MM	\$247.95
050381	16", Miter/Straight.....	50/60MM	299.95





ProSeries® 14" Milling Wheel

For stationary saws and milling machines.

- Available in metal body or lightweight nylon body
- 50/60mm Arbor

Stock No.	Description	Price
102848	1 1/2" wide, Metal Body.....	\$880.00
102849	1 1/2" wide, Nylon Body.....	1,025.00

Stock No.	Description	Price
919104	60/50 Arbor Rings.....	\$27.99



Diarex® 14" Milling Wheel

For gauging slabs on stationary saws and milling machines.

- 1 1/2" width x 14" diameter
- 60mm Arbor

Stock No.	Description	Price
102841	14" Milling Wheel Steel Core	\$1,395.00
102846	14" Milling Wheel Teflon Core (Pictured)	1,255.00



Dongsin® 14" Milling Wheel

Dongsin® Milling Wheels are the perfect option for milling slabs or leveling a concrete table, and are available in both a granite and a concrete bond. Both options feature an ultra quiet Teflon® core and forty-four 40mm segments for grinding, with an additional 3 segments on the side of each wheel for extra core protection.

- Features a lightweight nylon body
- 40mm Wide segments
- 50/60mm Arbor

Stock No.	Description	Price
123095	14" Milling Wheel For Granite.....	\$1,249.00
123096	14" Milling Wheel For Concrete.....	1,249.00



Wood Table Milling Wheels

Milling Wheels designed specifically for calibrating wooden saw tables.

The wheel is equipped with special tungsten carbide blades to abate the saw table. A perfectly calibrated saw table is the most important requirement for precise miter cuts, tables should be milled often for optimal results.

- Calibrating router for calibrating of saw tables
- Fast work progress, high stock removal performance
- Router is designed with 6 special tungsten carbide blades

Stock No.	Description	Price
490163	14" Milling Wheel For Wood Tables.....	\$995.00
490160	14" Replacement Core.....	509.15
490161	Tungsten Carbide Replacement Blade	97.84
931152	Farnese Milling Wheel for Wood Tables.....	1,950.00



Diarex® Black Magic 4" Wet Polishing Pads

Designed to bring out the deep rich color in natural and engineered stone surfaces. Black Magic's aggressive lower grits allow you to achieve a beautiful polish in less time than with comparable pads.

- Saves time
- Excellent for granite, marble and engineered stone surfaces
- Wet use only

Stock No.	Color/Grit	Price
637505	● 50.....	\$19.50
637506	● 100.....	19.50
637507	● 200.....	19.50
637508	● 400.....	19.50

Stock No.	Color/Grit	Price
637509	● 800.....	\$19.50
637510	● 1500.....	19.50
637511	● 3000.....	19.50

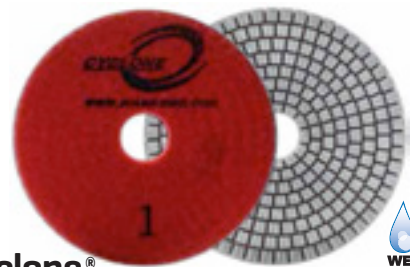

Cyclone® 3-Step Polishing Pads

- Light color resin for polishing lighter colored stones without bleeding
- Unique diamond matrix for easy 3-step polishing
- Wet use only

Stock No.	Color/Position	Price
363697	● 1.....	\$21.95
363698	● 2.....	21.95
363699	● 3.....	21.95



Hurricane® 3-Step Polishing Pads

An extremely flexible 3-Step polishing system for polishing granite as well as concrete. Optional position zero pad available (extends the life of primary polishing pads and deepens the polish).

Stock No.	Color/Position	Price
103680	● 0.....	\$21.99
103681	● 1.....	21.99
103682	● 2.....	21.99
103683	● 3.....	21.99

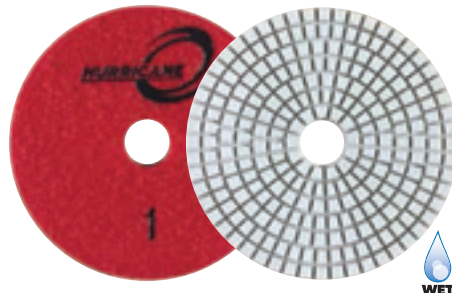

Hurricane® White Resin 3-Step Polishing Pads

- Light color resin
- Excellent for granite, marble and engineered stone surfaces
- Wet use only

Stock No.	Color/Position	Price
103684	● 1.....	\$20.99
103685	● 2.....	20.99
103686	● 3.....	20.99

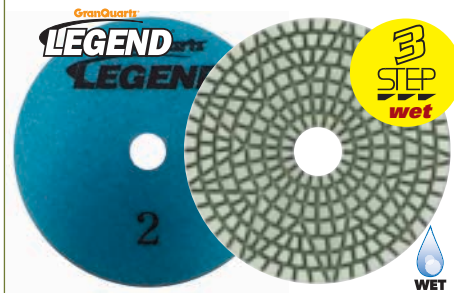

Legend® 3-Step Wet Polishing Pads

An extremely flexible 3-Step polishing system.

- Saves time
- Light color resin
- Excellent for granite, marble and engineered stone surfaces
- Wet use only

Stock No.	Color/Position	Price
171520	● 1.....	\$24.99
171521	● 2.....	24.99
171522	● 3.....	24.99

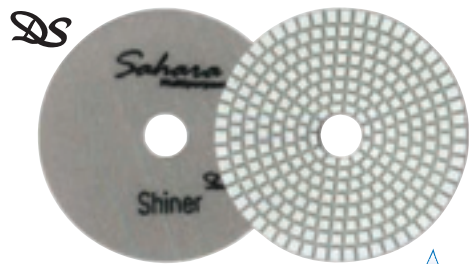

Dongsin® Sahara™ 4" Wet Polishing Pads

For polishing Granite, Marble & Engineered Stone.

- Special Resin Bond
- 2,000-3,000 Max. RPM
- Wet use Only

Stock No.	Color/Grit	Price	Stock No.	Color/Grit	Price
122749	● 50.....	\$28.95	122746	● 800.....	\$28.95
122743	● 100.....	28.95	122747	● 1500.....	28.95
122744	● 200.....	28.95	122748	● 3000.....	28.95
122745	● 400.....	28.95	122750	● Buff.....	28.95



Dongsin® Cuatro™ 4" Wet Polishing Pads

- Extremely Flexible Pads
- For polishing Granite, Marble and Engineered Stone Surfaces
- Wet Polishing Only
- Use at 2,000-3,000 RPM

Stock No.	Color/Position	Price
122691	● Step 1.....	\$27.95
122692	● Step 2.....	27.95
122693	● Step 3.....	27.95
122694	● Step 4.....	27.95

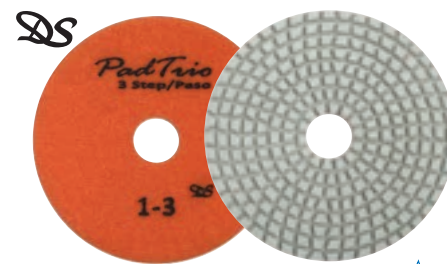

Dongsin® DS Pad Trio White Resin 3-Step Polishing Pads

White resin works great on all stone types with a high diamond concentration for aggressive cutting and a high polish.

- Great flexibility out of the box
- 2,000-3,000 Max. RPM
- Wet polish granite, marble, engineered stone

Stock No.	Color/Position	Price
123145	● Step 1.....	\$26.99
123146	● Step 2.....	26.99
123147	● Step 3.....	26.99

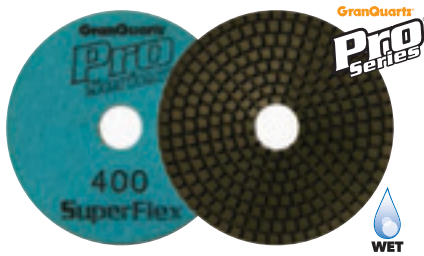

Most FLEXIBLE Polishing Pad in the Stone Industry!

Pro Series® Super Flex 4" Wet Polishing Pads

Great for finishing Ogee & other technical profiles.

- Ultra flexible, great on granite, engineered stone and other natural stone surfaces

Stock No.	Color/Grit	Price	Stock No.	Color/Grit	Price
993773	● 50	\$18.99	993777	● 800	\$18.99
993774	● 100	18.99	993778	● 1500	18.99
993775	● 200	18.99	993779	● 3000	18.99
993776	● 400	18.99			

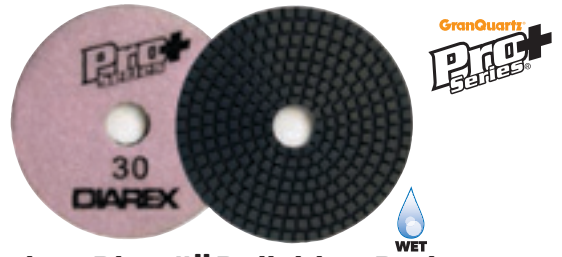

Pro Series® Plus 4" Polishing Pads

- Great for polishing of granite, marble and engineered stone surfaces
- 3.5mm thickness

Flexibility	🌟🌟🌟🌟🌟
Polish	🌟🌟🌟🌟🌟
Pad Life	🌟🌟🌟🌟🌟

Stock No.	Color/Grit	Price	Stock No.	Color/Grit	Price
119427	● 30	\$22.95	119433	● 1000	\$22.95
119429	● 50	22.95	119434	● 2000	22.95
119430	● 100	22.95	119435	● 3000	22.95
119431	● 300	22.95	119436	● Buff Black	26.95
119432	● 500	22.95	119437	○ Buff White	26.95



GranQuartz® Legend® Green Polishing Pads

Superior diamond/resin formulation provides a superior polish on marble and granite.

- Q.R.S.-backed for quick grit changes
- Available in 3", 4", and 5" diameters

Guaranteed to Last Longer, while producing a SUPERIOR FINISH!

Flexibility	🌟🌟🌟🌟🌟
Polish	🌟🌟🌟🌟🌟
Pad Life	🌟🌟🌟🌟🌟

3"

Stock No.	Color/Diam./Grit	Price
118552	● 3", 40	\$25.99
118553	● 3", 60	25.99
118554	● 3", 100	25.99
118555	● 3", 200	25.99
118556	● 3", 400	25.99
118557	● 3", 800	25.99
118558	● 3", 1500	25.99
118559	● 3", 3000	25.99
118560	● 3", FinalBuff	34.99

4"

Stock No.	Color/Diam./Grit	Price
118534	● 4", 40	\$34.99
118535	● 4", 60	34.99
118536	● 4", 100	34.99
118537	● 4", 200	34.99
118538	● 4", 400	34.99
118539	● 4", 800	34.99
118540	● 4", 1500	34.99
118541	● 4", 3000	34.99
118542	● 4", FinalBuff	44.99

5"

Stock No.	Color/Diam./Grit	Price
118570	● 5", 40	\$45.99
118571	● 5", 60	45.99
118574	● 5", 100	45.99
118577	● 5", 200	45.99
118580	● 5", 400	45.99
118583	● 5", 800	45.99
118586	● 5", 1500	45.99
118589	● 5", 3000	45.99
118593	● 5", FinalBuff	49.99

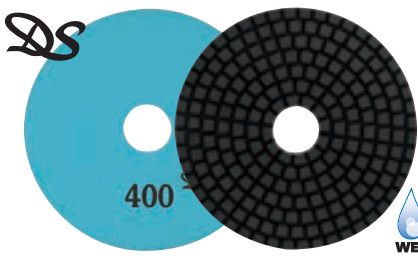

Dongsin® Premium Wet Polishing Pads

- Q.R.S.-backed
- Available in 4" and 5"

Stock No.	Diam./Grit	Price	Stock No.	Diam./Grit	Price
122612	4", 30	\$21.99	122626	5", 30	\$25.99
122610	4", 50	19.99	122624	5", 50	24.99
122598	4", 100	19.49	122613	5", 100	24.99
122599	4", 200	19.49	122614	5", 200	24.99
122600	4", 300	19.49	122615	5", 300	24.99
122601	4", 400	19.49	122616	5", 400	24.99
122602	4", 500	19.49	122617	5", 500	24.99
122604	4", 800	19.49	122618	5", 600	24.99
122605	4", 1000	19.49	122619	5", 800	24.99
122606	4", 1500	19.49	122620	5", 1000	24.99
122607	4", 2000	19.49	122621	5", 1500	24.99
122608	4", 3000	19.49	122622	5", 2000	24.99
122609	4", 6500	19.49	122623	5", 3000	24.99
122344	4", Final Buff B	26.95	122346	5", Final Buff B	32.99
122345	4", Final Buff W	26.95	122347	5", Final Buff W	32.99

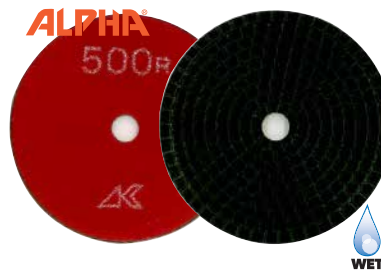

Alpha® Ceramica Resin Polishing Pads

For professional quality, fast polishing of granite, hard marble and porcelain ceramics. High quality industrial diamonds and bond materials ensure the best possible finish on polished stone.

Stock No.	Color/Diam./Grit	Price	Stock No.	Color/Diam./Grit	Price
116123	● 3", 150	\$32.09	116189	○ 4", FinalBuff W	\$77.80
116124	● 3", 300	32.09	116193	● 4", FinalBuff B	77.80
116126	● 3", 500	32.09			
116127	● 3", 1000	32.09			
116128	● 3", 2000	32.09			
116129	● 3", 3000	32.09			
116132	○ 3", FinalBuff W	63.07			
116133	● 3", FinalBuff B	63.07			

Stock No.	Color/Diam./Grit	Price
116174	● 4", 150	\$43.10
116177	● 4", 300	43.10
116178	● 4", 500	43.10
116179	● 4", 1000	43.10
116180	● 4", 2000	43.10
116181	● 4", 3000	43.10

Stock No.	Color/Diam./Grit	Price
116217	● 5", 150	\$62.13
116219	● 5", 300	62.13
116220	● 5", 500	62.13
116221	● 5", 1000	62.13
116222	● 5", 2000	62.13
116223	● 5", 3000	62.13
116224	○ 5", FinalBuff W	100.72
116225	● 5", FinalBuff B	100.72



Diarex® Mongoose Resin Bonded Granite Polishing Pads

- Excellent for granite, marble, engineered stone surfaces
- Extra long life
- 3mm thickness
- Available in 3", 4" or 5" diameters

Flexibility	
Polish	
Pad Life	

Stock No.	Color/Diam./Grit	Price
600920	● 3", 50	\$16.99
600921	● 3", 100	16.99
600922	● 3", 200	16.99
600923	● 3", 400	16.99
600924	● 3", 800	16.99
600925	● 3", 1500	16.99
600926	○ 3", 3000	16.99

Stock No.	Color/Diam./Grit	Price
600900	● 4", 50	\$21.99
600901	● 4", 100	21.99
600902	● 4", 200	21.99
600903	● 4", 400	21.99
600904	● 4", 800	21.99
600905	● 4", 1500	21.99
600906	○ 4", 3000	21.99
600907	● 4", FinalBuff B...	25.99
600908	○ 4", FinalBuff W..	25.99

Stock No.	Color/Diam./Grit	Price
600910	● 5", 50	\$25.99
600911	● 5", 100	25.99
600912	● 5", 200	25.99
600913	● 5", 400	25.99
600914	● 5", 800	25.99
600915	● 5", 1500	25.99
600916	○ 5", 3000	25.99
600917	● 5", FinalBuff B...	35.99
600918	○ 5", FinalBuff W..	35.99



Rival® P Wet Polishing Pads

Extremely fast polishing with very high gloss. Specially designed chamfered edge eliminates cutting in.

- Textured to eliminate break in
- 3mm thick
- Use Wet Only
- Use Under 5,000 RPM

Stock No.	Color/Diam./Grit	Price
363490	● 3", 50	\$12.99
363491	● 3", 100	12.99
363492	● 3", 200	12.99
363493	● 3", 400	12.99
363494	● 3", 800	12.99
363495	● 3", 1500	12.99
363496	● 3", 3000	12.99

Stock No.	Color/Diam./Grit	Price
363442	● 4", 50	\$15.99
363444	● 4", 100	15.99
363445	● 4", 200	15.99
363446	● 4", 400	15.99
363448	● 4", 800	15.99
363450	● 4", 1500	15.99
363451	● 4", 3000	15.99



Weha® Trio 3-Step Polishing Pads

Geometric Water Displacement Technology Pattern design allows water to flow across and through the pad more efficiently, keeping the pad from hydroplaning for more aggressive contact with the stone. GWD Pattern allows a faster, better polish than "brick pattern" pads.

- Geo Pattern design eliminates the segment loss on edges of pad
- Great on light and dark quartz, engineered stone, granite & quartzite
- White Hybrid bond will not bleed or leave marks on light or dark quartz or other stone surfaces

Stock No.	Description	Price
446058	Step 1	\$25.00
446059	Step 2	25.00
446060	Step 3	25.00



Weha® Trilogy 3-Step Polishing Pads

Geometric Water Displacement Technology Pattern design allows water to flow across and through the pad more efficiently, keeping the pad from hydroplaning for more aggressive contact with the stone. Proprietary design results in a faster, better polish.

- Geo Pattern design eliminates the segment loss on edges of pad
- Designed specifically for polishing Black, Brown, Gray, and other darker colored Engineered Stone, Quartz stone surfaces

Stock No.	Description	Price
367681	Step 1, HYBRID	\$25.00
367682	Step 2, HYBRID	25.00
367683	Step 3, HYBRID	25.00

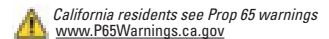

NEW!

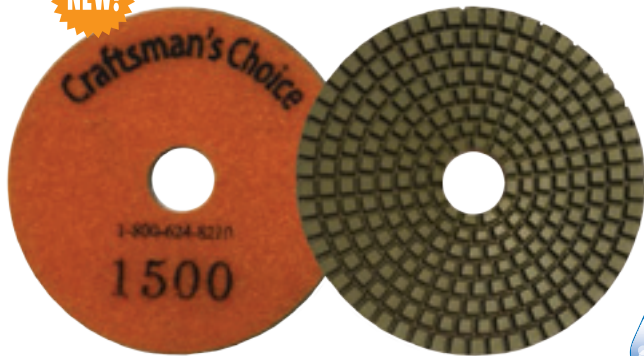

Craftsman's Choice 7-Step Resin Polishing Pads

A great value for all polishing needs, Craftsman's Choice pads can be used on natural or engineered stone for a great polish. Available in the most popular sizes and in grits 50 – 3,000 as well as black or white final buff.

- Pads become more flexible with use
- Max. RPM: 4,000
- Use Wet Only

Stock No.	Color/Diam./Grit	Price	Stock No.	Color/Diam./Grit	Price
445785	● 3", 50	\$12.00	445802	● 4", 50	\$15.00
445786	● 3", 100	12.00	445803	● 4", 100	15.00
445787	● 3", 200	12.00	445804	● 4", 200	15.00
445788	● 3", 400	12.00	445805	● 4", 400	15.00
445789	● 3", 800	12.00	445806	● 4", 800	15.00
445790	● 3", 1500	12.00	445807	● 4", 1500	15.00
445791	● 3", 3000	12.00	445808	● 4", 3000	15.00

NEW!

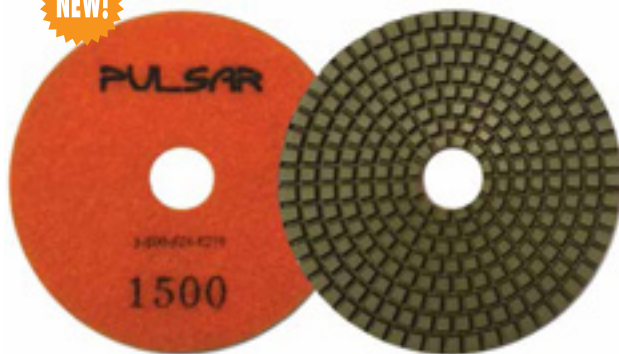

Pulsar® 4" 7-Step Polishing Pads

Pulsar Wet polishing pads are engineered with a concentrated resin & diamond formula for longer life and faster polishing times.

- Superior results on granite, marble and engineered stone surfaces
- True five step system eliminates the need for buffing pads
- Max. RPM: 4,000

Stock No.	Color/Grit	Price	Stock No.	Color/Grit	Price
445876	● 50	\$16.95	445880	● 800	\$16.95
445877	● 100	16.95	445881	● 1500	16.95
445878	● 200	16.95	445882	● 3000	16.95
445879	● 400	16.95			

NEW!



Craftsman's Choice Superflex 4" Wet/Dry Polishing Pads

Very versatile for shop or field use. Craftsman's Choice pads are very flexible allowing fast, efficient polishing of radius edges. New manufacturing process makes these an extremely good value.

- Pads become more flexible with use
- Max. RPM: 4,000
- Use Wet Only

Stock No.	Color/Diam./Grit	Price
445785	● 3", 50	\$12.00
445786	● 3", 100	12.00
445787	● 3", 200	12.00
445788	● 3", 400	12.00
445789	● 3", 800	12.00
445790	● 3", 1500	12.00
445791	● 3", 3000	12.00



Diarex® Mongoose Elite 5-Step Polishing System

- Superior results on granite, marble and engineered stone surfaces
- True five step system eliminates the need for buffing pads
- Ultra flexible design

Stock No.	Color/Step	Price	Stock No.	Color/Step	Price
600390	● 1	\$22.50	600393	● 4	\$22.50
600391	● 2	22.50	600394	● 5	22.50
600392	● 3	22.50			

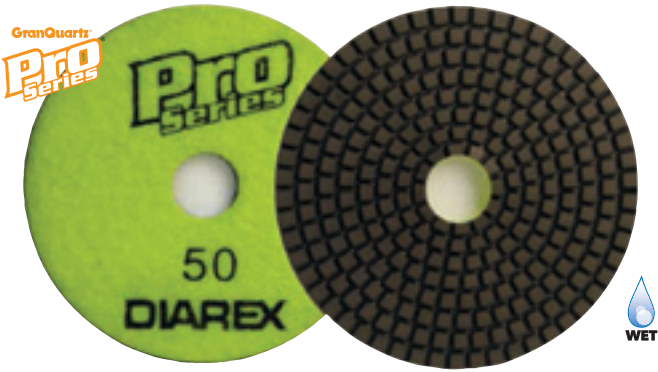

Pro Series® Polishing Pads

- Excellent for granite, marble, and engineered stone surfaces
- Available in 3", 4", or 5" diameters

Flexibility	
Polish	
Pad Life	

Stock No.	Color/Diam./Grit	Price
119400	● 3", 50	\$12.99
119401	● 3", 100	12.99
119402	● 3", 200	12.99
119403	● 3", 400	12.99
119404	● 3", 800	12.99
119405	● 3", 1500	12.99
119406	● 3", 3000	12.99
119407	● 3", FinalBuff B	16.99
119408	○ 3", FinalBuff W	16.99

Stock No.	Color/Diam./Grit	Price
119409	● 4", 50	\$15.99
119410	● 4", 100	15.99
119411	● 4", 200	15.99
119412	● 4", 400	15.99
119413	● 4", 800	15.99
119414	● 4", 1500	15.99
119415	● 4", 3000	15.99
119416	● 4", FinalBuff B	18.99
119417	○ 4", FinalBuff W	18.99

Stock No.	Color/Diam./Grit	Price
119418	● 5", 50	\$23.99
119419	● 5", 100	23.99
119420	● 5", 200	23.99
119421	● 5", 400	23.99
119422	● 5", 800	23.99
119423	● 5", 1500	23.99
119424	● 5", 3000	23.99
119425	● 5", FinalBuff B	29.99
119426	○ 5", FinalBuff W	29.99



Pro Series® Hybrid 3-Step Polishing Pads

Pro Series Hybrid pads are produced with a unique resin formula allowing them to be used wet or dry. Reduce polishing time by 50% on granite or engineered stone surfaces.

- Use for Wet or Dry polishing, best results when used wet
- Q.R.S. backed for quick pad changes

Stock No.	Color/Position	Price
114765	● 1	\$30.99
114766	● 2	30.99
114767	● 3	30.99

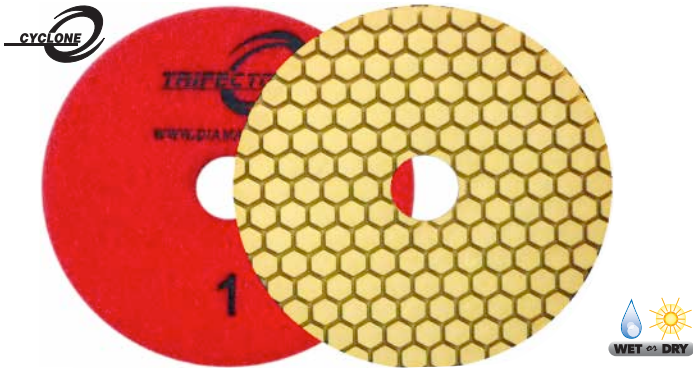

Cyclone® Trifecto® 3-Step Polishing Pads

- Reduces polishing time by 50%
- Use Wet or Dry, best results when used wet
- For polishing granite, engineered stone and other natural stone surfaces

Stock No.	Color/Position	Price
490125	● 1	\$32.95
490126	● 2	32.95
490127	● 3	32.95



Diarex® 3-Step 4" Hybrid Polishing Pads

Ultra flexible with an optional position zero for a deeper shine and to extend life of steps 1-3. Extremely fast process from first polishing step to completion.

- Ultra flexible, 4" or 5" pads
- Use Wet or Dry, best results when used wet

Stock No.	Diam.	Color/Step	Price	Stock No.	Diam.	Color/Step	Price
114726	4"	● 0, Optional	\$32.99	114730	5"	● 0, Optional	\$41.99
114727	4"	● 1	32.99	114733	5"	● 1	41.99
114728	4"	● 2	32.99	114734	5"	● 2	41.99
114729	4"	● 3	32.99	114735	5"	● 3	41.99

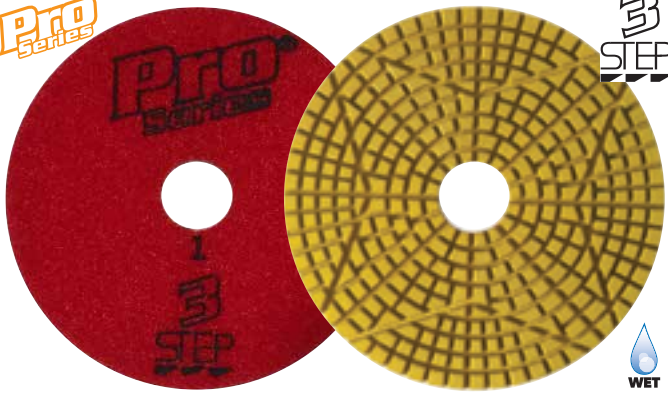

Pro Series® 4" 3-Step Polishing Pads

Pro Series 3-Step pads are designed for achieving an extremely fast process from beginning to final polish.

- Ultra flexible pads
- Great for polishing granite, engineered stone and other natural stone surfaces

Stock No.	Color/Position	Price
114721	● 1	\$21.99
114722	● 2	21.99
114723	● 3	21.99



Copper Head 4" Polishing Pads

Copper bond helps to dissipate heat for longer useful polishing life of pad. Polishes granite, marble & engineered stone.

- Q.R.S. connection
- Recommended use below 4,000 RPM
- Wet use ONLY

Stock No.	Color/Grit	Price	Stock No.	Color/Grit	Price
363441	● 35	\$22.74	363422	● 800	\$22.74
363418	● 50	22.74	363423	● 1500	22.74
363419	● 100	22.74	363424	● 3000	22.74
363420	● 200	22.74	363425	● 5000	22.74
363421	● 400	22.74			

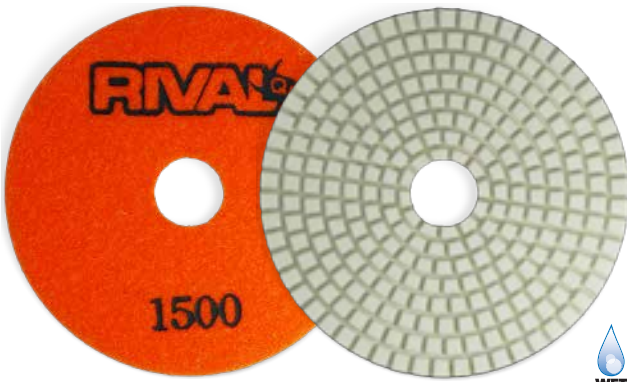

Rival® Quartz 7-Step 4" Wet Polishing Pads

Non-marking white resin will not bleed into lighter colored engineered stone surfaces. Can be used on granite and marble.

- Max RPM: 5,000
- White resin
- For wet polishing

Stock No.	Color/Grit	Price	Stock No.	Color/Grit	Price
363585	● 50	\$16.99	363589	● 800	\$16.99
363586	● 100	16.99	363590	● 1500	16.99
363587	● 200	16.99	363591	● 3000	16.99
363588	● 400	16.99			



Pro Series® 4" ICE Polishing Pads

Pro Series Ice pads are 2.8mm thick and are produced specifically for Engineered Stone, but also works great on all natural stone surfaces.

- For polishing Granite & other Natural Stone surfaces
- White resin
- For wet polishing

Stock No.	Color/Grit	Price	Stock No.	Color/Grit	Price
119732	● 50	\$18.99	119736	● 800	\$18.99
119733	● 100	18.99	119737	● 1500	18.99
119734	● 200	18.99	119738	● 3000	18.99
119735	● 400	18.99			



GranQuartz
DIAREX®

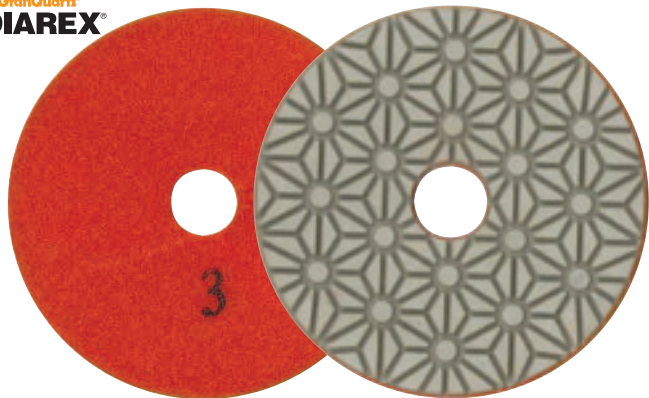

Diarex® Ice 3-Step 4” Wet Polishing Pads



A unique lighter colored resin and a special diamond matrix allows polishing lighter colored stone surfaces with reduced chance of discoloration.

- Wet polishing
- Designed specifically for engineered stone surfaces, also works great on granite

Stock Number	Color/Position	Price
112708	●1	\$22.79
112709	●2	22.79
112710	●3	22.79

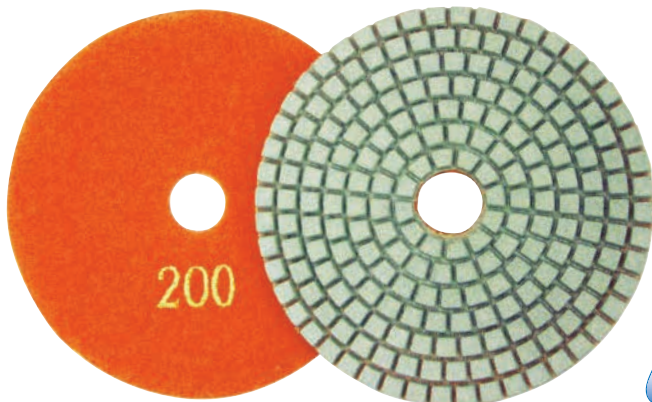

Diarex® Ice Wet Polishing Pads

Ice Pads are made with a unique type of lighter colored resin and a special diamond matrix for polishing lighter colored stone surfaces with reduced chance of discoloration.

- Designed specifically for engineered stone surfaces, also works great on granite
- Available in 3", 4" or 5" diameter

Stock No.	Color/Diam./Grit	Price
112719	● 3", 50	\$18.23
112720	● 3", 100	18.23
112721	● 3", 200	18.23
112722	● 3", 400	18.23
112723	● 3", 800	18.23
112724	● 3", 1500	18.23
112725	● 3", 3000	18.23

Stock No.	Color/Diam./Grit	Price
112712	● 4", 50	\$21.65
112713	● 4", 100	21.65
112714	● 4", 200	21.65
112715	● 4", 400	21.65
112716	● 4", 800	21.65
112717	● 4", 1500	21.65
112718	● 4", 3000	21.65

Stock No.	Color/Diam./Grit	Price
112729	● 5", 50	\$28.49
112730	● 5", 100	28.49
112731	● 5", 200	28.49
112732	● 5", 400	28.49
112733	● 5", 800	28.49
112734	● 5", 1500	28.49
112735	● 5", 3000	28.49

NEW!



Pulsar® Universal Wet/Dry 5-Step Polishing Pads

Pulsar 5 Step System eliminates the need for lower grits & final buff pads saves time compared with typical 8 step polishing.

- Eliminates lower grits for less polishing time
- 4-5 Steps for engineered stone, 4 steps for most other stone

Stock No.	Description	Price
446154	Step 0, Wet/Dry.....	\$23.67
446155	Step 1, Wet/Dry.....	23.67
446156	Step 2, Wet/Dry.....	23.67
446157	Step 3, Wet/Dry.....	23.67
446158	High Gloss, Wet/Dry.....	23.67

NEW!



Craftman's Choice Superflex Wet/Dry Pads

Craftman's Choice Superflex pads are extremely versatile with a high degree of flexibility for fast, efficient polishing of all radius edges.

- Great for radius polishing
- Max RPM: 4,000

Stock No.	Diam./Grit	Price
446001	4", 50	\$15.00
446002	4", 100	15.00
446003	4", 200	15.00
446004	4", 400	15.00
446005	4", 800	15.00
446006	4", 1500	15.00
446007	4", 3000	15.00

Dust and Silica Warning See Inside Front Cover

California residents see Prop 65 warnings www.P65Warnings.ca.gov



Assassin® 2 4" White Resin Polishing Pads

Assassin 2 White Resin Pads are made with a unique type of lighter colored resin to reduce the chance of discoloration when polishing light colored stone & engineered stone surfaces.

- Ultra flexible pads
- Best results when used wet
- Great for granite or engineered stone surfaces

Stock No.	Grit	Price	Stock No.	Grit	Price
602063	50	\$11.99	602067	800	\$11.99
602064	100	11.99	602068	1500	11.99
602065	200	11.99	602069	3000	11.99
602066	400	11.99			



Assassin® 2 Wet Polishing Pads

Assassin 2 Wet Pads are an incredible value in wet polishing.

- Available in 3", 4", or 5"

Stock No.	Color/Diam./Grit	Price	Stock No.	Color/Diam./Grit	Price
602043	● 3", 50	\$7.99	602034	● 4", 1500	\$8.99
602044	● 3", 100	7.99	602035	● 4", 3000	8.99
602045	● 3", 200	7.99	602036	○ 4", White Buff	13.99
602046	● 3", 400	7.99	602037	● 4", Black Buff	13.99
602047	● 3", 800	7.99			
602048	● 3", 1500	7.99			
602049	● 3", 3000	7.99			
602050	○ 3", White Buff	13.99			
602051	● 3", Black Buff	13.99			
Stock No.	Color/Diam./Grit	Price	Stock No.	Color/Diam./Grit	Price
602029	● 4", 50	\$8.99	602052	● 5", 50	\$18.99
602030	● 4", 100	8.99	602053	● 5", 100	18.99
602031	● 4", 200	8.99	602054	● 5", 200	18.99
602032	● 4", 400	8.99	602055	● 5", 400	18.99
602033	● 4", 800	8.99	602056	● 5", 800	18.99
			602057	● 5", 1500	18.99
			602058	● 5", 3000	18.99

Flexibility	🌿🌿🌿🌿🌿
Polish	🌿🌿🌿🌿🌿
Pad Life	🌿🌿🌿🌿🌿

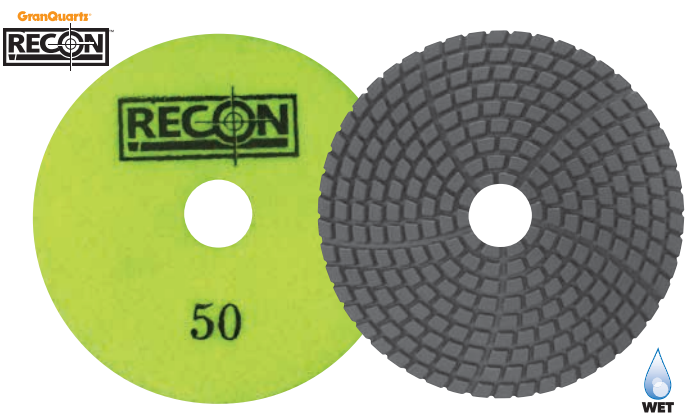

Recon™ 4" Wet Polishing Pads

- Great for polishing granite or engineered stone surfaces
- Great polish at an economical price

Stock No.	Grit	Price
697631	50	\$9.99
697632	100	9.99
697633	200	9.99
697634	400	9.99
697635	800	9.99
697636	1500	9.99
697637	3000	9.99
697638	Buff Black	16.99
697639	Buff White	16.99

Flexibility	🌿🌿🌿🌿🌿
Polish	🌿🌿🌿🌿🌿
Pad Life	🌿🌿🌿🌿🌿

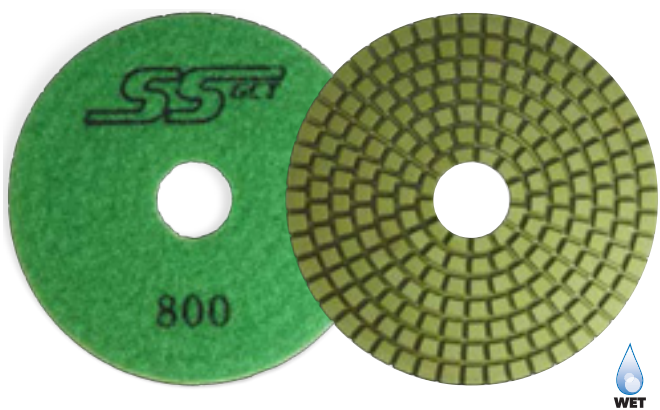

Rival® Super Sport Wet Polishing Pads

Extremely fast polishing with very high gloss, Super Sport pads are designed with a chamfered edge to eliminate cutting in.

- 3mm thick
- Use Wet Only
- Use Under 5,000 RPM

Stock No.	Diameter/Grit	Price	Stock No.	Diameter/Grit	Price
363600	3", 50	\$14.99	363609	4", 50	\$16.99
363601	3", 100	14.99	363610	4", 100	16.99
363602	3", 200	14.99	363611	4", 200	16.99
363603	3", 400	14.99	363612	4", 400	16.99
363604	3", 800	14.99	363613	4", 800	16.99
363605	3", 1500	14.99	363614	4", 1500	16.99
363606	3", 3000	14.99	363615	4", 3000	16.99

DRY POLISHING

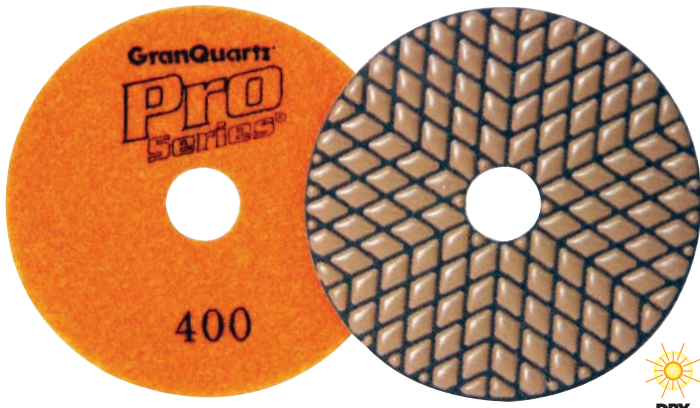

**Pro Series®
Dry Polishing Pads**



Pro Series® Dry Polishing pads are extremely flexible making them easy for the operator to use while providing a fantastic finish on granite and engineered stone surfaces.

- Polish granite wet or dry, engineered stone wet only
- Available in 4" or 5" Diameters

Stock No.	Diam./Grit	Price	Stock No.	Diam./Grit	Price
920657	4", 60	\$23.95	920531	5", 60	\$32.95
920658	4", 100	23.95	920532	5", 100	32.95
920659	4", 200	23.95	920533	5", 200	32.95
920660	4", 400	23.95	920534	5", 400	32.95
920661	4", 800	23.95	920535	5", 800	32.95
920662	4", 1500	23.95	920536	5", 1500	32.95
920663	4", 3000	23.95	920537	5", 3000	32.95
920664	4", 5000/BUFF	23.95	920538	5", 5000/Buf	34.95

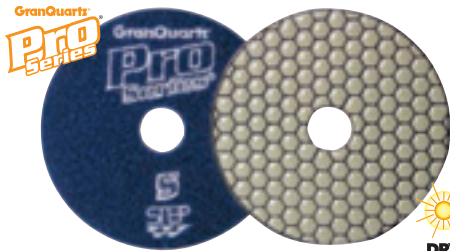

**Pro Series® 4" 5-Step
Dry Polishing Pads**

Pro Series® Five Step Dry Polishing pads are extremely flexible for ease of operator use, and they provide an excellent finish on granite and engineered stone surfaces.

- Extremely fast process from beginning to final polish
- Ultra flexible
- Polish granite wet or dry, engineered stone wet only

Stock No.	Step	Price
693456	1	\$23.95
693457	2	23.95
693458	3	23.95
693459	4	23.95
693460	5	23.95

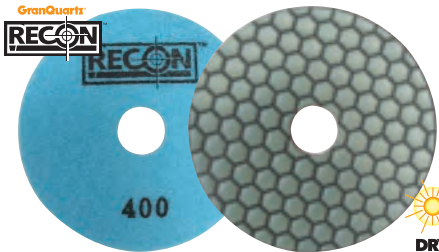

**Recon™
4" Dry Polishing Pads**

- Provides an excellent polish
- Great value, long life and very flexible
- Polish granite wet or dry, engineered stone wet only

Stock No.	Grit	Price	Stock No.	Grit	Price
697659	50	\$17.95	697664	1500	17.95
697660	100	17.95	697665	3000	17.95
697661	200	17.95	697666	Black/Buf	17.95
697662	400	17.95	697667	White/Buf	17.95
697663	800	17.95			

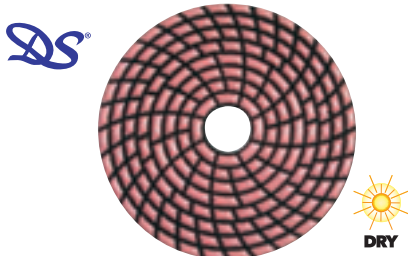

**Dongsin® Cactus "G"
Dry Polishing Pads/Granite**

Cactus G Dry Polishing pads are great for polishing granite.

- For wet or dry polishing of granite
- For engineered stone wet only
- Less dust and odor compared to traditional pads
- Premium quality

Stock No.	Diam./Grit	Price
122273	4", 30	\$27.50
122272	4", 50	26.50
122269	4", 100	26.50
122270	4", 200	26.50
122265	4", 400	26.50
122266	4", 800	26.50
122267	4", 1500	26.50
122268	4", 3000/Buf	26.50
122271	4", 5000/Shiner	27.50

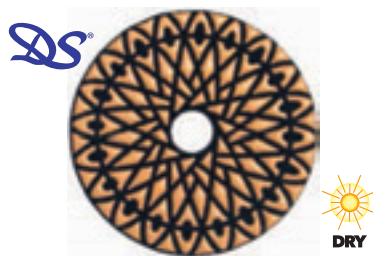

**Dongsin® Cactus "M"
Dry Polishing Pads/Marble**

Cactus M Dry Polishing pads are great for polishing marble.

- For wet or dry polishing of marble
- For engineered stone wet only
- Creates less dust and odor
- Premium quality

Stock No.	Diam./Grit	Price
122291	4", 30	\$25.50
122289	4", 50	25.50
122283	4", 100	24.50
122284	4", 200	24.50
122285	4", 400	24.50
122286	4", 800	24.50
122287	4", 1500	24.50
122288	4", 3000/Buf	24.50
122290	4", 5000/Shiner	25.50

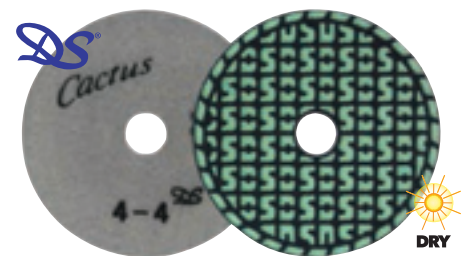

**Dongsin® Cactus™
4-Step Dry Polishing Pads**

- Extremely fast polishing process
- 2,000-3,000 Max. RPM
- Polish granite wet or dry, engineered stone wet only

Stock No.	Step	Price
122253	1	\$28.50
122254	2	28.50
122255	3	28.50
122256	4	28.50



It's OK to Use Water on Dry Pads! Using water in a spray bottle or a damp sponge with the dry pads will reduce dust and help extend the life of your pads. On some surfaces it will also SPEED UP the process.



Cyclone® Dry Flex 5-Step Dry Polishing Pads

Super high gloss finish in 5 steps or less allows user to spend less than 3 minutes per step.

- Q.R.S. connection
- 4,000 RPM wet or dry

Stock No.	Position	Price
363511	1	\$31.95
363512	2	31.95
363513	3	31.95
363514	4	31.95
363515	5	31.95

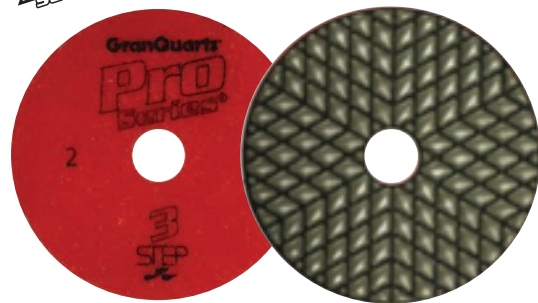

Pro Series® 3-Step Dry Polishing Pads

- Very flexible pads
- For dry polishing Granite & other Natural Stone Surfaces
- Use at 2,000-3,000 RPM

Stock No.	Step/Grit	Price
920455	Step 1	\$26.95
920456	Step 2	26.95
920457	Step 3	26.95

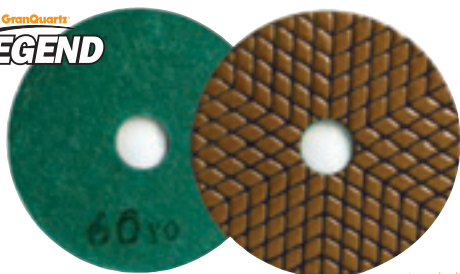

Legend® 4" Dry Polishing Pads

Legend Dry pads may be used to polish granite wet or dry, engineered stone wet only.

- Flexible design
- Optimal RPM: Dry - 2,000, Wet - 4,000

Stock No.	Grit	Price
363592	60	\$31.95
363593	100	31.95
363594	200	31.95
363595	400	27.95
363596	800	24.95
363597	1500	24.95
363598	3000	24.95
363599	5000/Buf.....	24.95

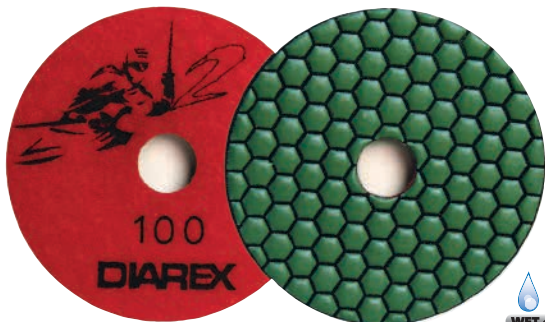

Assassin® II 4" Dry Polishing Pads

Assassin II pads are for polishing granite wet or dry, engineered stone wet only.

- Perfect for jobsite touch up use
- Long-life, low cost formula
- Optimal RPM: Dry - 2,000, Wet - 4,000

Stock Number	Color/Grit	Price
600890	● 50	\$17.95
600891	● 100	17.95
600892	● 200	17.95
600893	● 400	17.95
600894	● 800	17.95
600895	● 1500	17.95
600896	● 3000	17.95
600897	● 5000/Buf....	24.75



Cyclone® Dryflex 4" Dry Polishing Pads

- Extremely flexible design provides a fantastic finish
- Polish granite wet or dry, engineered stone wet only

Stock Number	Color/Grit	Price
694594	● 60	\$35.95
694595	● 100	35.95
694596	● 200	35.95
694597	● 400	35.95
694598	● 800	35.95
694599	● 1500	35.95
694600	● 3000	35.95
694601	● 4000	35.95
694602	● 5000	35.95

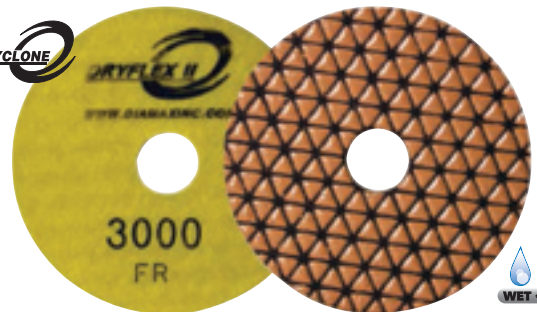

Cyclone® Dryflex II 4" Dry Polishing Pads

Provides the same degree of polish as the original DryFlex

- Super Flexible design
- Polish granite wet or dry, engineered stone wet only

Stock Number	Color/Grit	Price
490106	● 60	\$28.95
490107	● 100	28.95
490108	● 200	28.95
490109	● 400	28.95
490110	○ 800	28.95
490111	● 1500	28.95
490112	● 3000	28.95
490113	● 4000	28.95
490114	● 5000	28.95

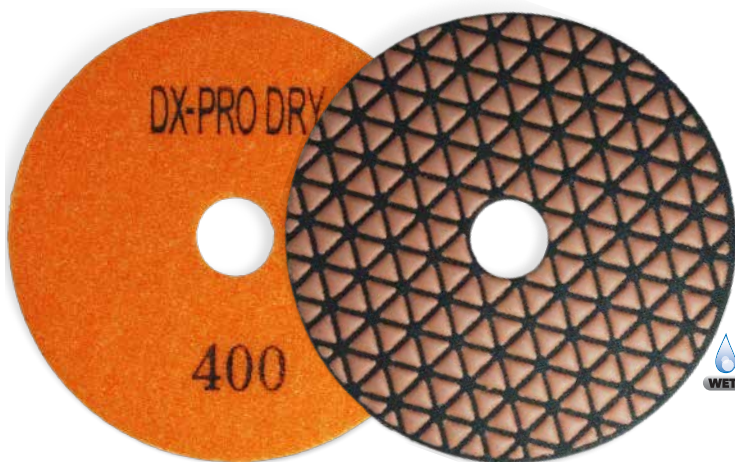

Rival DX-Pro Dry Polishing Pads

Extreme High Speed professional dry pads are great for wet or dry polishing granite, marble and engineered stone surfaces.

- Q.R.S. connection
- 4,000 RPM wet or dry
- Engineered stone wet only

Stock No.	Diam./Grit	Price
363402	4", 60	\$14.95
363403	4", 100	14.95
363404	4", 200	14.95
363405	4", 400	14.95
363406	4", 800	14.95
363407	4", 1500	14.95
363408	4", 3000	14.95
363409	4", 4000	14.95

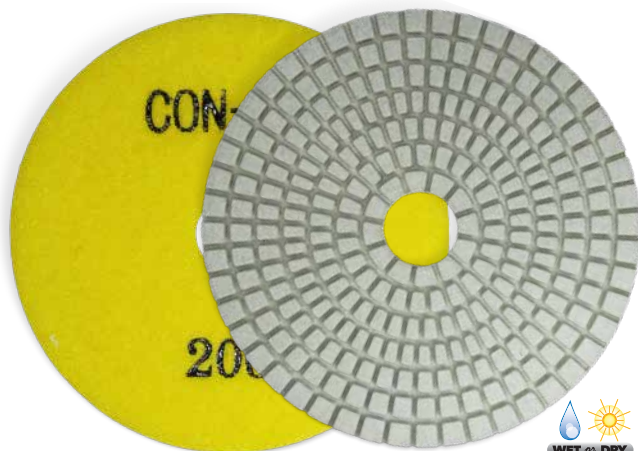

Rival Con-DRI Dry Polishing Pads for Concrete

Con-DRI pads are extremely flexible, formulated with non-marking white resin and are great for wet or dry polishing concrete surfaces.

- Q.R.S. connection
- 4,000 RPM wet or dry

Stock No.	Diam./Grit	Price	Stock No.	Diam./Grit	Price	Stock No.	Diam./Grit	Price
363384	4", 50	\$17.09	363392	5", 50	\$25.07	363499	7", 50	\$46.68
363385	4", 100	17.09	363393	5", 100	25.07	363500	7", 100	46.68
363386	4", 200	17.09	363394	5", 200	25.07	363501	7", 200	46.68
363387	4", 400	17.09	363395	5", 400	25.07	363502	7", 400	46.68
363388	4", 800	17.09	363396	5", 800	25.07	363503	7", 800	46.68
363389	4", 1500	17.09	363397	5", 1500	25.07	363504	7", 1500	46.68
363390	4", 3000	17.09	363398	5", 3000	25.07	363505	7", 3000	46.68



SPECIALIZED POLISHING PADS

ALPHA®



Alpha® Ceramica TF 4" Polishing Pads

Alpha® Ceramica TF, a flexible resin pad designed to achieve a textured finish on engineered stone. Use Positions 0 through 3 after a standard 200 grit polish pad for best results. Effortlessly create a textured look on internal corners and sink rims.

- 4" Positions 0-3
- Wet use only
- For Engineered Stone
- Max RPM 4,000
- Use after 200 grit polish for best results

Stock No.	Color	Description	Price
800594	OrangePos. 0	\$31.65
800595	RedPos. 1	31.65
800569	GreenPos. 2	31.65
800570	Light GreenPos. 3	31.65



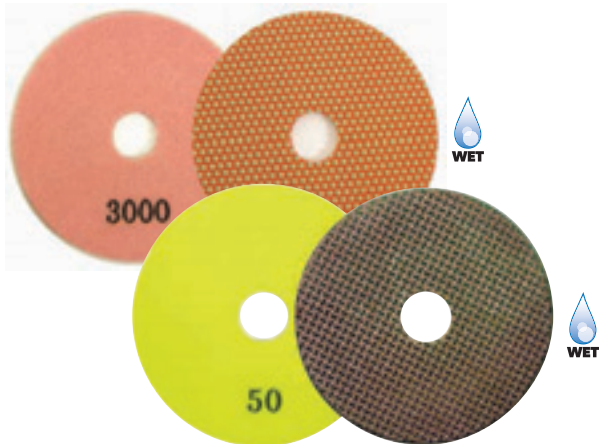

Pro Series® Polishing Discs Electroplated and Resin Bonds



- Wet use only
- Available in 4" or 5" Diameters
- Excellent on marble and a variety of other materials

Stock No.	Diam./Type/Grit	Price	Stock No.	Diam./Type/Grit	Price
108570	4", Metal, 50	\$29.95	108577	5", Metal, 50	\$47.95
108571	4", Metal, 100	24.95	108578	5", Metal, 100	41.95
108572	4", Metal, 200	21.95	108579	5", Metal, 200	34.95
108573	4", Metal, 400	19.95	108580	5", Metal, 400	34.95
108574	4", Metal, 800	19.95	108581	5", Metal, 800	30.95
108575	4", Metal, 1500	19.95	108582	5", Metal, 1500	30.95
108576	4", Metal, 3000	19.95	108583	5", Metal, 3000	30.95



Genesis™ Abrasive Discs



Designed to grind, hone and polish surfaces to a smooth finish. Genesis™ sanding discs work well on almost all hard surfaces and substances including glass, ceramics, stone, plastics and composites.

Stock No.	Diam./Type/Grit	Price
695494	3", Diamond, 70	\$24.95
695495	3", Diamond, 120	21.95
695496	3", Diamond, 220	17.95
695497	3", Diamond, 400	15.95
695499	3", Diamond, 600	14.95
695500	3", Diamond, 800	14.95
695501	3", Diamond, 1800	14.95
Stock No.	Diam./Type/Grit	Price
695504	4", Diamond, 70	\$45.95
695505	4", Diamond, 120	38.95
695506	4", Diamond, 220	31.95
695507	4", Diamond, 400	28.95
695508	4", Nickel, 600	30.95
695509	4", Diamond, 600	25.95
695510	4", Diamond, 800	25.95
695511	4", Diamond, 1800	25.95
695512	4", Diamond, 3500	25.95

Stock No.	Diam./Type/Grit	Price
695514	5", Diamond, 70	\$71.95
695515	5", Diamond, 120	60.95
695516	5", Diamond, 220	50.95
695517	5", Diamond, 400	45.95
695518	5", Nickel, 600	45.95
695519	5", Diamond, 600	41.95
695520	5", Diamond, 800	41.95
695521	5", Diamond, 1800	41.95
695522	5", Diamond, 3500	41.95
Stock No.	Diam./Type/Grit	Price
695523	7", Diamond, 70	\$125.95
695524	7", Diamond, 120	108.95
695525	7", Diamond, 220	90.95
695526	7", Diamond, 400	73.95

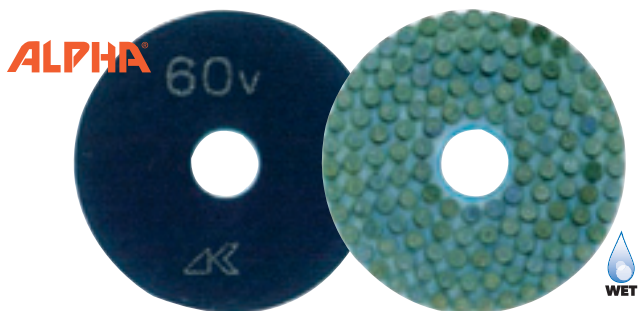

Alpha® Ceramica Vitrified Polishing Discs

For professional quality, fast polishing of granite, hard marble and porcelain ceramics. High quality industrial diamonds and bond materials ensure the best possible finish on polished stone. Four types of discs are used to take a stone from a rough condition to a high polish.

- Wet use only

Stock No.	Color/Diam./Grit	Price	Stock No.	Color/Diam./Grit	Price
116116	● 3", 60	\$68.37	116214	● 5", 60	\$134.09
116118	● 3", 150	56.12	116216	● 5", 150	110.22
116125	● 3", 300	56.12	116218	● 5", 300	110.22
Stock No.	Color/Diam./Grit	Price			
116173	● 4", 60	\$96.57			
116175	● 4", 150	76.79			
116176	● 4", 300	76.79			

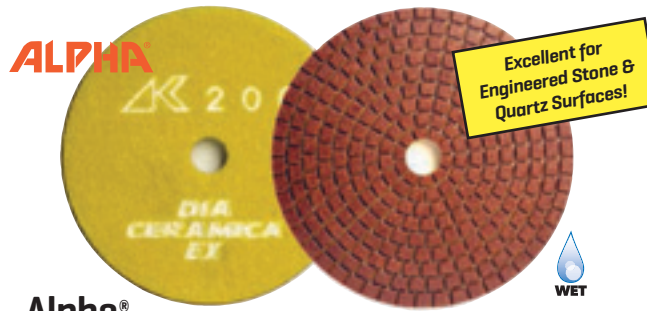

Alpha® Ceramica EX Polishing Pads

Excellent for Engineered Stone & Quartz Surfaces!

Ceramic EX Pads are great for polishing engineered stone or quartz surfaces after initial grinding/polishing with a 60# vitrified disc. Use of a final buffer is required on most types of granite.

- Wet use only
- QRS-backed pads

Stock No.	Diam./Grit	Price	Stock No.	Diam./Grit	Price
800500	3", 200	\$19.39	800505	5", 200	\$35.47
800501	3", 500	19.39	800506	5", 500	35.47
800502	3", 1000	19.39	800507	5", 1000	35.47
800503	3", 2000	19.39	800508	5", 2000	35.47
800504	3", 3000	19.39	800509	5", 3000	35.47
Stock No.	Diam./Grit	Price			
116194	4", 200	\$23.55			
116195	4", 500	23.55			
116196	4", 1000	23.55			
116197	4", 2000	23.55			
116198	4", 3000	23.55			



Black Magic® 4" Diamond Resin Cup Wheel

Black Magic pad utilizing RGT technology, combining the feel of a polishing pad and the aggressive cutting action of a diamond cup wheel.

- UCS Products- for best results use 100 grit and 200 grit
- Granite- 30 grit for creating bevel and 50 grit for cleaning up fine scratches from 30 grit
- Produces TRUE chip-free beveling
- Aluminum backed w/Fem. 5/8-11 thread

Natural Stone			UCS/Porcelain		
Stock No.	Grit	Price	Stock No.	Grit	Price
637512	30	\$39.95	637514	100	\$39.95
637513	50	39.95	637515	200	39.95



Pro Series® ES Pads

Designed for polishing engineered stone, with a unique resin pattern on steps 4, 5, & 6 to prevent burning of the surface caused by excess pressure.

- Recommended RPM: 2500-3000
- Wet use only

Stock No.	Description	Price	Stock No.	Description	Price
116756	4", Step 1	\$21.95	116763	4", Step 5	\$21.95
116758	4", Step 2	21.95	116764	4", Step 6	21.95
116760	4", Step 3	21.95	116765	4", Buff	29.95
116761	4", Step 4	21.95			



Pro Series® 4" Copper Polishing Pads

Pro Series® Copper Pads are great for stock removal, honing, and polishing. They are extremely flexible and can be used in combination with your favorite polishing pad to extend the life.

- Extremely flexible
- Use dry or wet

Stock No.	Diam./Grit	Price	Stock No.	Diam./Grit	Price
993706	4", 30	\$49.95	993710	4", 400	\$49.95
993707	4", 50	49.95	993711	4", 800	49.95
993708	4", 100	49.95	993712	4", 1500	49.95
993709	4", 200	49.95	993713	4", 3000	49.95

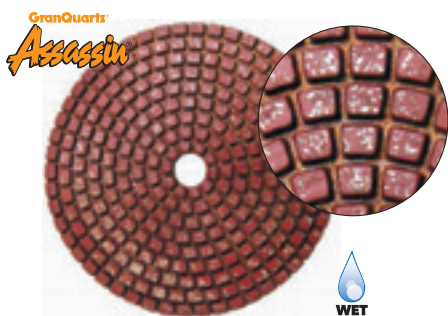

Assassin® Metal Hybrid Polishing Pads

- Copper bond encapsulated in resin
- Extremely long life & when used in combination with resin pads extends pad life

Stock No.	Type/Grit	Price
602038	Metal Hybrid, 30	\$20.46
602039	Metal Hybrid, 50	20.46
602040	Metal Hybrid, 100	20.46
602041	Metal Hybrid, 200	20.46
602059	Metal Hybrid, 400	20.46
602060	Metal Hybrid, 800	20.46
602061	Metal Hybrid, 1500	20.46
602062	Metal Hybrid, 3000	20.46

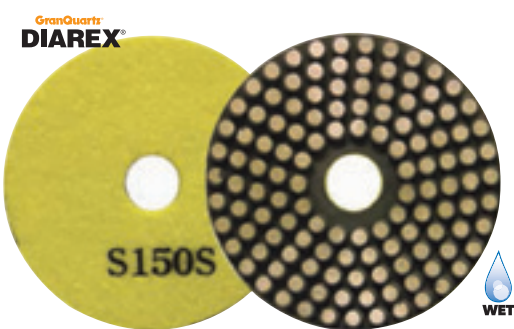

Diarex® 4" Metal Dot Grinding Pads

- Aggressive, long lasting pads w/copper bond and QRS backing
- Use for light shaping, scratch removal
- Perfect for cleaning up inside corners and bowl cutouts
- Wet use only

Stock No.	Type/Grit	Price
600847	Metal Dot, 30	\$48.95
600848	Metal Dot, 60	42.95
600849	Metal Dot, 150	42.95

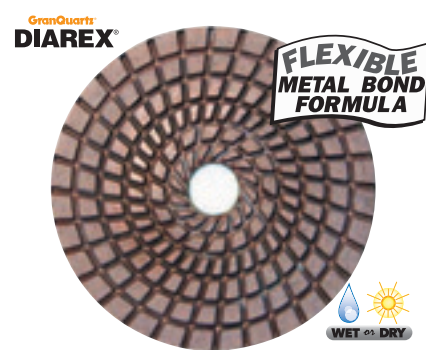

Diarex® 4" Flexible Metal Grinding Pads

- Used for light shaping
- Q.R.S. backed
- Use dry or wet

Stock No.	Type/Grit	Price
118261	Metal, 40/50	\$49.95
118262	Metal, 50/60	49.95
118263	Metal, 120/140	49.95
118264	Metal, 180/220	49.95

SEAM POLISHING

ALPHA

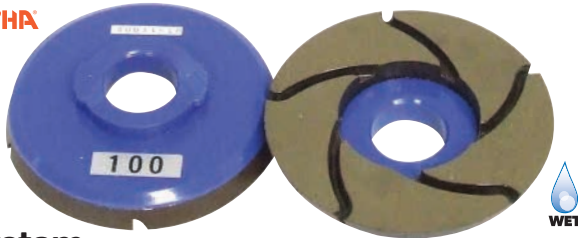

Alpha® Turboshine Seam Polishing System

Produce seamless countertop installations and scratch removal on natural and engineered stone. Alpha's "Dual Adapter System", dramatically reduces vibration during operation. Allows the operator to change discs without changing the drive system, reducing down time between grits.

- Minimal Vibration
- Excellent for Scratch Removal
- Reduces Downtime
- Wet use only

Stock No.	Description	Price
940014	100 Grit, Rigid Disc.....	\$45.74
940015	200 Grit, Rigid Disc.....	45.74
940016	500 Grit, Rigid Disc.....	45.74
940017	1000 Grit, Rigid Disc.....	45.74
940018	2000 Grit, Rigid Disc.....	45.74
940019	3000 Grit, Rigid Disc.....	45.74
930230	Buff White, Rigid Disc.....	63.89
940020	Buff Black, Rigid Disc.....	63.89

ALPHA



Turboshine Dual Adapter

Stock No.	Description	Price
940013	Dual Adapter	\$31.70

Pro Series® Seam Polishing System

The Pro Series® seam polishing system is great for scratch removal, seam polishing, restoration, drain boards, and other flat polishing jobs that require a high quality of polish with precision control.

- Durable brass core with an extremely rigid base
- Special quick-connection system that allows use as 5/8"-11 or 1/2" gas with the same adaptor
- 4,000 RPM Max.
- Wet use only

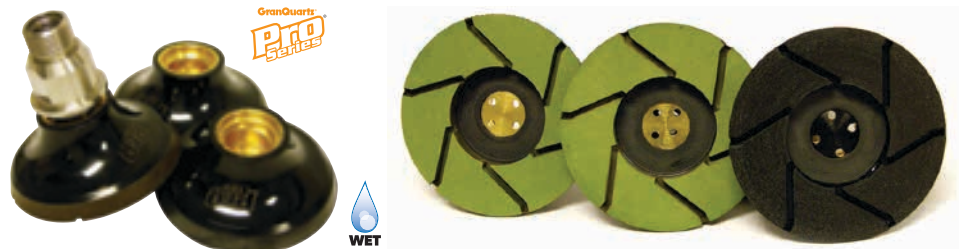

Stock No.	Description	Price
104691	100 Grit.....	\$36.95
104692	200 Grit.....	36.95
104693	500 Grit.....	36.95
104694	1000 Grit.....	36.95
104695	2000 Grit.....	36.95

Stock No.	Description	Price
104696	3000 Grit.....	\$36.95
104697	Buff Black.....	39.95
104698	Buff White.....	39.95
600982	Adaptor-5/8"-11 & 1/2 Gas.....	45.00

NSI SL3™ Hook & Loop Backer Pads

Fits NSI SL3 Adapter, allows for quick changes between polishing pads.

- Quick change Snail Lock system
- Available in 3", 4", 5" or 7" diameter
- 7" Backer fits hog hair polishing pads



Stock No.	Description	Price
790435	7" SL3 Backer.....	\$39.95
790434	5" SL3 Backer.....	29.95
790433	4" SL3 Backer.....	18.95
790432	3" SL3 Backer.....	14.95
790405	SL3 5/8"-11 Adapter.....	49.95



NSI SL3™ 3" Floating Turbo Abrasive Wheels

Produced using a proven abrasive formula with a semi-rigid backing to help them run flat for their entire life. Hook & loop attachment with center hub enables the turbo to "float", promoting smoother operation, more relaxed control and provides a shorter learning curve for the new fabricator.

- Optimized for easy top & edge polishing
- Center hub backer keeps the turbo centered
- Color-coded for easy identification

Stock No.	Description	Price
790438	60 Grit Rigid Floating Turbo	\$29.95
790439	150 Grit Rigid Floating Turbo	29.95
790440	300 Grit Rigid Floating Turbo	29.95
790441	500 Grit Rigid Floating Turbo	29.95
790442	1000 Grit Rigid Floating Turbo	29.95
790443	2000 Grit Rigid Floating Turbo	29.95
790444	3000 Grit Rigid Floating Turbo	29.95
790437	3", H&L CTR Hub Backer	\$18.95
790405	SL3 5/8"-11 Adapter	49.95

NSI SL3™ 3" Rigid Turbo Polishing Pads

Use for top polishing or other jobs requiring fine control over stock removal and flatness. Great for dressing seams (60, 150 and 300 grit).

- Quick change Snail Lock system

Stock No.	Description	Price
790407	60 Grit Turbo Pad.....	\$39.99
790408	150 Grit Turbo Pad.....	39.99
790409	300 Grit Turbo Pad.....	39.99
790410	500 Grit Turbo Pad.....	39.99
790411	1000 Grit Turbo Pad.....	39.99
790412	2000 Grit Turbo Pad.....	39.99
790413	3000 Grit Turbo Pad.....	39.99
790405	SL3 5/8"-11 Adapter.....	49.95

NSI solutions





Dongsin® 3-1/2" Turbo Discs

Designed for light surface scratches on polished faces. Excellent for notches where flexible discs are prone to premature wear from edge damage.

- Wet use only



#122072 Backup Pad

Stock No.	Grit	Price	Stock No.	Grit	Price
122686	30	\$33.95	122679	1500	\$25.95
122684	50	29.95	122681	3000	25.95
122671	100	25.95	122682	Black/Buf	29.95
122672	200	25.95	122683	White/Buf	29.95
122674	400	25.95	122072	Backup Pad	15.95
122677	800	25.95			

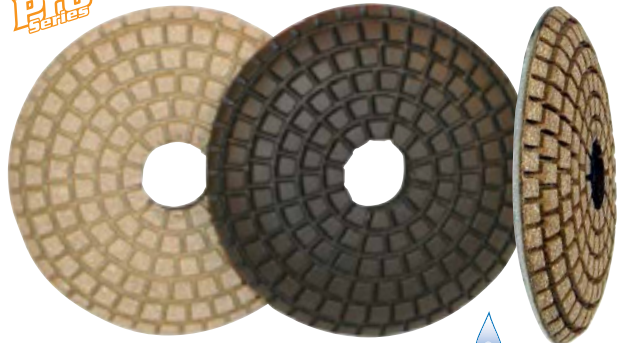

Pro Series® 3" Convex Wet Polishing Pads

- Wet use only
- Maximum RPM 4,000

Stock No.	Grit	Price
119448	50	\$23.95
119449	100	23.95
119450	200	23.95
119451	400	23.95
119452	800	23.95
119453	1500	23.95
119454	3000	23.95

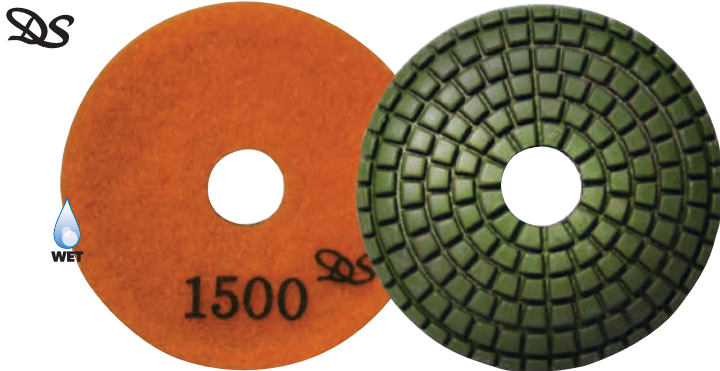

Dongsin® 3" Convex Wet Polishing Pads

- For wet polishing granite

Stock No.	Grit	Price	Stock No.	Grit	Price
122320	50	\$28.95	122317	1500	\$26.95
122308	100	26.95	122319	3000	26.95
122310	200	26.95	122322	Buff-Black	29.95
122312	400	26.95	122323	Buff-White	29.95
122315	800	26.95			

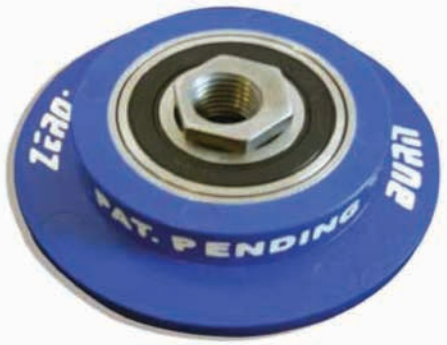

Zero Burn Backup Pad

Multi-directional action saves time by cross-cutting the stone with each revolution of the tool. This speeds up the polishing process and results in a tighter polishing pattern.

- Eliminates surface or edge "burn"
- Achieves a higher shine polish
- Use on granite, natural stone surfaces
- 5/8" -11 Female arbor

Stock No.	Description	Price
291832	Rigid Style	\$119.00



Polishing Pro 3" Random Orbital Sander

Random orbital sander designed for restoration of natural stone, engineered stone and glass surfaces.

- Orbit diameter: 1/8"
- Orbits/minute: 3,500 - 10,000
- Motor: 2 Amps, 240 Watts

Stock No.	Desc.	Price
291837	3" Orbital Sander	\$99.00

Quartz Renew Restoration Products

Designed to pick up where diamond polishing finished or correct small damaged areas to bring the material up to match the factory finish. The 3-step polish chemicals puts texture back into the repair area and removes any residual hazing from polishing. Great method for removing common issues like suction cup marks, A-frame marks, acetone burns, stains & other surface flaws or dings.

- Removes marks left by cups or equipment during fabrication
- Simple 3-step system restores polish

Stock No.	Description	Price
293820	QR Starter KIT (Includes all items below with asterisk)	\$185.95
293808	*QR 4" Polishing Pad, Step 1	17.50
293809	*QR 4" Polishing Pad, Step 2	17.50
293810	*QR 4" Polishing Pad, Step 3	17.50
293811	*QR 4" Polishing Pad, Step 4	17.50
293800	*QR Snake Skin Revealer, 8 Oz.	32.26
293801	*QR Resin Polish, 8 Oz.	29.95
293802	*QR Final Polish, 8 Oz.	40.95
293817	*Lambswool 6.5" QRS-Backed Buffing Pad	7.95
293818	*Green Poly-Foam 6.5" QRS-Backed Light Polishing Pad	7.95
293819	*White Poly-Foam 6.5" QRS-Backed Light Polishing Pad	7.95

Stock No.	Description	Price
291816	QR Kit, Resin, Final Polish, Snake Skin Revealer	110.28
790435	NSI SL3 7" Rigid Backer	39.95
790405	NSI SL3 5/8"-11 Adapter	49.95

Quartz Renew 4" 6-Step Polishing Pads

Quartz Renew 6-Step pads provide the ultimate quality in surface restoration and are designed to work in tandem with Quartz Renew products.

- Removes marks left by cups or equipment during fabrication
- 6-step polishing system restores polish to granite, engineered stone and quartz surfaces

Stock No.	Description	Price
445734	Resin Polishing Pad, 50 Grit.....	\$14.50
445735	Resin Polishing Pad, 100 Grit.....	14.50
445736	Resin Polishing Pad, 200 Grit.....	14.50
445737	Resin Polishing Pad, 400 Grit.....	14.50
445738	Resin Polishing Pad, 800 Grit.....	14.50
445739	Resin Polishing Pad, 1500 Grit.....	14.50
445740	Resin Polishing Pad SET, (6 Pads, 50-1500 Grit).....	79.00



600027Flex® PE14-2 150 Rotary Polisher (sold separately)



Sorma® I-Dia Dry Polishing Pads

Sorma I-Dia pads are for wet or dry sanding stone materials and engineered stones instead of using traditional abrasive pads. Designed to eliminate surface burning during finishing stages..

- Use wet or dry
- Excellent results on all materials

Stock No.	Grit	Diameter	Price
445759	60	4"	\$19.35
445760	120	4"	19.35
445761	200	4"	19.35
445762	400	4"	19.35
445763	800	4"	19.35
445764	1500	4"	19.35
445765	3000	4"	19.35



Pro Series® Q.R.S.-Backed Silicon Carbide Sanding Discs

Long-lasting, aggressive 4" and 5" discs in eight grits from 60-600.

- Use wet or dry
- Maximum RPM: 4000
- Resists loading
- Sold in boxes of 50 pieces



Stock No.	Grit	Diameter	Price	Stock No.	Grit	Diameter	Price
930049	60	4"	\$16.72	930059	60	5"	\$24.09
930050	80	4"	15.35	930060	80	5"	21.93
930051	120	4"	14.85	930061	120	5"	21.44
930052	240	4"	14.85	930062	240	5"	21.44
930053	320	4"	14.85	930063	320	5"	21.44
930054	400	4"	14.85	930064	400	5"	21.44
930055	500	4"	14.85	930065	500	5"	21.44
930056	600	4"	14.85	930066	600	5"	21.44



Alpha® Q.R.S.-Backed Silicon Carbide Sanding Discs



- Use wet or dry
- Maximum RPM: 4000
- Sold in boxes of 50 pieces
- Choose 4" or 5" diameter discs

Stock No.	Grit	Diameter	Price	Stock No.	Grit	Diameter	Price
116266	80	4"	\$20.42	116273	80	5"	\$28.47
116267	120	4"	20.42	116275	120	5"	28.47
116268	240	4"	20.42	116276	240	5"	28.47
116269	320	4"	20.42	116277	320	5"	28.47
116270	400	4"	20.42	116278	400	5"	28.47
116271	500	4"	20.42	116279	500	5"	28.47
116272	600	4"	20.42	116280	600	5"	28.47
116265	Assorted	4"	21.71	116274	Assorted	5"	28.93



Pearl® Q.R.S.-Backed Abrasive Sanding Discs

- Use wet or dry
- Maximum RPM: 4000
- Sold in box of 50
- Premium "Grade A" silicon carbide grain
- High-intensity heat resistant glue
- Velcro™ brand hook and loop material
- Bonding resin developed specifically for use on natural and engineered stone

Stock No.	Grit	Diameter	Price	Stock No.	Grit	Diameter	Price
600335	80	4"	\$15.29	600342	80	5"	\$21.50
600336	120	4"	15.29	600343	120	5"	21.50
600337	220	4"	15.29	600344	220	5"	21.50
600338	320	4"	15.29	600345	320	5"	21.50
600339	400	4"	15.29	600346	400	5"	21.50
600340	500	4"	15.29	600347	500	5"	21.50
600341	600	4"	15.29	600348	600	5"	21.50



GranQuartz
DIAREX®

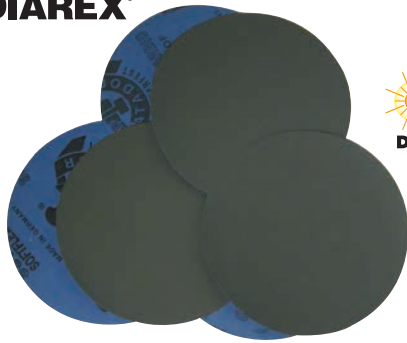

Diarex® 5" Sandpaper Discs

- Sold in packs of 100
- Spray-back or self adhesive
- Use dry only
- Maximum RPM: 4000

Stock No.	Grit	Description	Price/Box
950120	60	Adhesive back	\$30.00
950122	80	Adhesive back	26.00
950124	120	Adhesive back	26.00
950126	220	Adhesive back	26.00
950128	320	Adhesive back	26.00
950130	400	Adhesive back	26.00
950132	600	Adhesive back	26.00

Stock No.	Grit	Description	Price/Box
950000	40	Spray back	\$26.00
950005	60	Spray back	23.00
950010	80	Spray back	19.00
950020	120	Spray back	21.00
950025	180	Spray back	21.00
950030	220	Spray back	21.00
950035	320	Spray back	21.00
950040	400	Spray back	20.00
950050	600	Spray back	22.00
950055	800	Spray back	21.00
950060	1000	Spray back	21.00

GranQuartz
DIAREX®

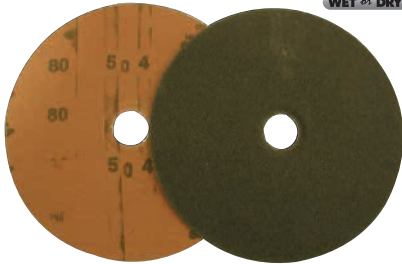

Diarex® 7" Cloth or Paper Backed Sandpaper Discs

- Attaches to GST rubber backing head
- 7/8" center hole
- Synthetic resin bond
- Use wet or dry
- Paper or resin-cloth backing
- Paper back discs (boxes of 100)
- Resin-cloth discs (boxes of 50)

Stock No.	Grit	Description	Price/Box	Stock No.	Grit	Description	Price/Box
949000	80	Paper back/100 Ct.	\$49.00	949012	36	Cloth back/50 Ct.	\$47.21
949002	120	Paper back/100 Ct.	43.00	949013	60	Cloth back/50 Ct.	41.40
949004	220	Paper back/100 Ct.	42.00	949014	80	Cloth back/50 Ct.	39.49
949006	320	Paper back/100 Ct.	44.00	949015	120	Cloth back/50 Ct.	36.22
				949016	220	Cloth back/50 Ct.	36.22
				949017	320	Cloth back/50 Ct.	36.22
				949018	400	Cloth back/50 Ct.	36.22
				949019	600	Cloth back/50 Ct.	34.10



Hermes® 7" Silicon Carbide Sanding Discs

- Sold in boxes of 50 or 100
- Use dry only



Stock No.	Diam.	Grit	Unit	Price
930080	7"	80	50 pcs.	\$20.53
930081	7"	120	100 pcs.	38.99
930082	7"	220	100 pcs.	38.99

Heavy Duty 7" Silicon Carbide Sanding Discs

- 7/8" Center hole
- Sold in boxes of 50
- Use wet or dry
- Cloth backed discs



Stock Number	Grit	Unit	Price
696226	80	50 pcs.	\$26.85
696227	120	50 pcs.	23.50
696228	220	50 pcs.	23.50
696229	320	50 pcs.	23.50
696230	400	50 pcs.	23.50



Camie® 300 Spray Adhesive

- General purpose spray adhesive
- For spray back sanding discs
- Provides temporary or permanent bond

Stock Number	Description	Price
951000	14 oz. Can	\$9.99



3M® Super 77 Spray Adhesive

- Bonds quickly in 15 seconds
- Securely bonds many lightweight materials
- Low soak-in for long lasting bond

Stock Number	Description	Price
696028	18 oz. Can	\$13.95

Pearl® Silicon Carbide Turbo Cut™ Discs

- Use dry only
- Grit C16
- For concrete, stone, cast iron and non-Ferrous Metals
- Max rpm: 13,300 (4") & 8,500 (7")

Stock No.	Description	Price
264553	4 1/2" x 7/8" Discs, Box of 25 pc.	\$104.75
569284	7" x 7/8" Discs, Pack of 25 pc.	161.25
100159	4 1/2" x 7/8" Discs, Pack of 6 pc.	27.95



PEARL



DRY

Heavy Duty Rubber Backing Pads

- For use with Pearl® Turbo Cut™ Discs
- With 5/8" -11 center nut

Stock No.	Description	Price
569285	4 1/2" w/Center Nut	\$31.00
569311	7" w/Center Nut.....	29.95



DRY

Hermes® 5" Peel & Stick Silicon Carbide Sanding Discs

- Use dry only
- Maximum RPM: 4000

Stock No.	Grit	Unit	Price
930000	80	50 pcs.	\$12.95
930005	120	100 pcs.	18.95
930010	220	100 pcs.	18.95
930015	240	100 pcs.	18.95
930020	320	100 pcs.	18.95
930025	400	100 pcs.	18.95
930030	500	100 pcs.	18.95

Hermes® 5" Velcro® Backed Silicon Carbide Sanding Discs

- Use dry only
- Maximum RPM: 4000

Stock No.	Grit	Unit	Price
699050	60	50 pcs.	\$26.95
699019	80	50 pcs.	26.95
930031	120	100 pcs.	41.48
930032	220	100 pcs.	41.48
930033	320	100 pcs.	41.48
930034	400	100 pcs.	41.48
930035	600	100 pcs.	41.48
930036	800	100 pcs.	41.48
930038	1200	100 pcs.	41.48

VSM® 5" Peel & Stick Sanding Discs

- The ultimate in sandpaper technology
- Available in E-weight (for dry use only) or A-Weight (wet or dry use)

Stock No.	Diam.	Grit	Type/Application	Unit	Price
697279	5"	40	E weight, dry use only	50 pcs.	\$20.50
697280	5"	60	E weight, dry use only	100 pcs.	38.00
697284	5"	80	E weight, dry use only	100 pcs.	32.95
697285	5"	120	E weight, dry use only	100 pcs.	30.50
698595	5"	220	E weight, dry use only	100 pcs.	30.50
698598	5"	500	A weight, wet or dry use	100 pcs.	29.50
698599	5"	600	A weight, wet or dry use	100 pcs.	29.50
698600	5"	800	A weight, wet or dry use	100 pcs.	29.50
698601	5"	1000	A weight, wet or dry use	100 pcs.	29.50
698602	5"	1200	A weight, wet or dry use	100 pcs.	29.50



WET or DRY



DRY

3M® 5" Silicon Carbide PSA Discs

- Use dry only
- Sold in tear-off rolls
- Available in grits 80-400

Stock Number	Grit	Sheets per Roll	Price
904051	80	125	\$42.13
904052	120	125	37.45
904053	150	175	53.02
904054	240	175	55.27
904055	320	175	56.38
904056	400	175	55.27



9"x 11" Silicon Carbide Sandpaper Sheets

Sold in packs of 50

Stock Number	Grit	Price
920180	80	\$47.94
920190	120	34.54
920200	180	27.84
920205	220	28.87
920210	280	27.00
920215	320	28.87
920220	400	28.87
920225	600	27.71



Rubbing Stones

Economical silicon carbide rubbing blocks for shaping and polishing granite and other hard surfaces, 1" x 2" x 8".

Stock No.	Grit	Price
960050	60	\$13.10
960051	80	14.31
960052	120	15.49
960053	220	15.49
960054	320	15.49



Silicon Carbide Resin Fiber Discs

- Synthetic resin bond for wet or dry sanding
- 7" diameter and 22.2mm (7/8") depressed center hole for attachment to GST rubber backing head
- Sold in boxes of 25 pcs.

Stock No.	Grit	Price per box
104375	24	\$72.00
104377	36	67.75
104380	60	61.25
104382	80	58.25
104384	120	58.25
104388	220	58.25
104392	400	58.25

PVA with 5/8" arbor recommended for 10,000 RPM.



Alpha® PVA Silicon Carbide Polishing Wheels



For quick, easy and economical polishing of marble edges and surfaces.

- Use dry on marble only
- Rough cutting to fine honing in only 4 steps
- 4", Snail-Lok Connection Wheels, 5 per box
- 4", 5/8" Threaded Wheels, 10 per box

4" with Snail-Lok Connection

Stock No.	Grit/Color	Unit	Price
116153	40, White	5/Box	\$43.90
116154	80, Red	5/Box	43.90
116155	220, Blue	5/Box	43.90
116156	400, Green	5/Box	43.90
116157	600, Yellow	5/Box	43.90

4" with 5/8" Connection

Stock No.	Grit/Color	Unit	Price
116140	40, White	10/Box	\$66.70
116142	80, Red	10/Box	66.70
116144	220, Blue	10/Box	66.70
116146	400, Green	10/Box	66.70
116148	600, Yellow	10/Box	66.70

Face Polishing Tool Combo Package

Great for scratch removal, seam polishing, restoration, drain boards, and other flat polishing jobs that require a high quality of polish with precision control.

Combo includes:

- GranQuartz® nylon tool bag
- Diarex® 4" aluminum backup head
- 5" Q.R.S. Diskit® backup pad
- Diarex® Quick-Change drum adapter
- 3 Pro Series® Seam Pro polishing discs
- 5 Pro Series® 4" polishing discs
- Super Met-al® white paint marker
- 106R Granite polishing paste (1Kg.)
- 1 Box (100 ct.) Pro Series® razor blades
- 8" Natural fiber buffing pad



Stock No.	Price
912139	\$469.95

Diarex® Form F/Ogee Profile Hand Pads

Stock No.	Grit	Type	Color	Price
270050	60	Metal, 2cm Form F	Green	\$27.51
270051	120	Metal, 2cm Form F	Black	25.18
270052	220	Metal, 2cm Form F	Red	21.73
270053	400	Metal, 2cm Form F	Yellow	20.67
270054	600	Metal, 2cm Form F	White	20.09
270055	800	Resin, 2cm Form F	White	16.93
270056	1800	Resin, 2cm Form F	Blue	16.91

Stock No.	Grit	Type	Color	Price
270060	60	Metal, 3cm Form F	Green	\$37.05
270061	120	Metal, 3cm Form F	Black	30.69
270062	220	Metal, 3cm Form F	Red	28.09
270063	400	Metal, 3cm Form F	Yellow	26.45
270064	600	Metal, 3cm Form F	White	26.50
270065	800	Resin, 3cm Form F	White	22.26
270066	1800	Resin, 3cm Form F	Blue	23.27

GranQuartz® DIAREX®



- 2cm & 3cm pads
- Pad size: 2 1/4 x 4"
- Use dry or wet



Stock No.	Color/Grit/Type	Price
108584	● 50, Metal	\$20.95
108585	● 100, Metal	18.95
108586	● 200, Metal	13.95
108587	● 400, Metal	13.95
108588	○ 800, Resin	11.95
108589	● 1500, Resin	9.95
108590	● 3000, Resin	9.95

Pro Series® Diamond Hand Pads

- Wet or Dry Use
- Excellent on Marble, Granite, Ceramic, or Engineered Stone Surfaces
- Available in 2 3/8" x 4"
- Use dry or wet



Stock No.	Color/Grit/Type	Price
260090	● 60, Metal	\$20.09
260091	● 120, Metal	15.89
260092	● 220, Metal	14.31
260093	● 400, Metal	13.00
260094	○ 600, Resin	13.84
260095	○ 800, Resin	9.92
260096	● 1800, Resin	9.54

Diarex® Unbacked Diamond Pads

- Excellent on Marble and a Variety of Other Materials
- 3" x 3" Abrasive Pads
- Use dry or wet

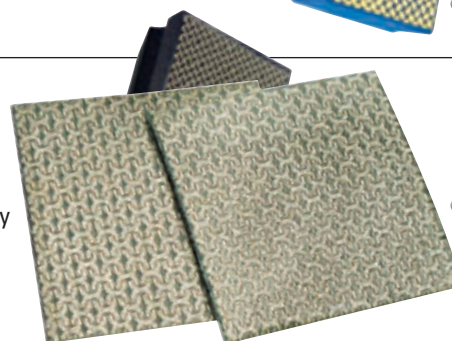

Stock No.	Color/Grit	Price
695598	● 70	\$21.95
695599	● 120	18.95
695600	● 220	15.95
695601	● 400	13.95
695602	● 600	11.95
695603	○ 800	11.95
695604	● 1800	11.95
695605	● 3500	11.95
695606	FULLSET, ALL 8 GRITS	112.95

Abrasive Technologies Diamond Hand Pads

Excellent for abrading marble, granite, agglomerated stone, ceramics, glass and composites. Their ideal hand size allows the finishing of surface shapes and areas that are hard to reach with power tools.

- Use dry or wet



GranQuartz® Quick-Change Polishing Drum

The GranQuartz® Quick Change Drum System is perfect for use with radial arm machines, various sink machines or by hand. This system matches high quality polishing tools with a new rapid release adapter for fast and easy tool changes.

- Brazed metal body or nylon body
- 3" Diameter drums



NEW, IMPROVED DESIGN!

Stock No.	Description	Price
600984	Brazed, 60 Grit.....	\$169.99
600986	Resin, 100 Grit.....	89.99
600987	Resin, 200 Grit.....	89.99
600988	Resin, 400 Grit.....	89.99
600989	Resin, 800 Grit.....	89.99
600990	Resin, 1500 Grit.....	89.99
100880	Oscillating HeadToolHolder, 1/2" Gas Conn.	589.99

Pro Series® 2" x 2" Resin Polishing Drum

- 5/8" - 11 Female connection
- Wet use
- Best resin polishing drums available

Stock No.	Description	Price
115851	Resin, 50 Grit.....	\$21.95
115852	Resin, 120 Grit.....	21.95
115854	Resin, 200 Grit.....	21.95
115855	Resin, 400 Grit.....	21.95
115856	Resin, 800 Grit.....	21.95
115857	Resin, 1500 Grit.....	21.95
115858	Resin, 3000 Grit.....	21.95
115859	Resin, Black Buff.....	27.95
115860	Resin, White Buff.....	27.95



GranQuartz® **PRO Series**

Diarex® Quick-Change 3" Polishing Drums

The Diarex® Quick-Change Drum System is perfect for use with radial arm machines, various sink machines or by hand. This system matches high quality polishing tools with a new rapid release adapter for fast and easy tool changes.

Stock No.	Description	Price	Stock No.	Description	Price
600973	Vac. Brazed, 50 Grit.....	\$149.00	600979	Resin, 3000 Grit.....	\$69.00
600974	Vac. Brazed, 100 Grit.....	149.00	600980	Resin, Final Buff/Black.....	79.00
600975	Resin, 200 Grit.....	69.00	600982	Drum Adapter	45.00
600976	Resin, 400 Grit.....	69.00			
600977	Resin, 800 Grit.....	69.00			
600978	Resin, 1500 Grit.....	69.00			

(1/2" Gas Male and 5/8"-11 Female to Quick-Change connection)

GranQuartz® **DIAREX®**



Rival Oscillating Head Drum Wheel System

Rival diamond grinding and polishing cylinders are for wet polishing with the RIVAL oscillating head. The drums are resin based diamond abrasives for scratch-free and precise angular polishing of bowl cutouts and edges.

- Center waterfed

Stock No.	Description	Price
362127	50 Grit, Resin	\$89.95
362128	100 Grit, Resin	89.95
362129	200 Grit, Resin	89.95
362130	400 Grit, Resin	89.95
362131	800 Grit, Resin	89.95
362132	1500 Grit, Resin.....	89.95
362133	3000 Grit, Resin.....	89.95
362134	Final Buff, Black	89.95
363718	Rival Oscillating Head.....	305.15



Rival Oscillating Head
• 5/8" - 11 Fem. Thread

SEGMENTED, WET DRILLING CORE BITS

PEARL



MAXIMUM PERFORMANCE AND LONG LIFE!



Pearl® P5™ Professional Wet Core Bits for Granite

- High diamond concentration for extra long life
- Special bond for long life, aggressive drilling and maximum performance
- 5/8-11 female thread
- Max 4,000 RPM
- Wet use only

Stock No.	Diameter	Price
940090	1".....	\$78.60
940092	1 3/8".....	100.95
940093	1 1/2".....	110.95
940094	2".....	128.99

PEARL



Pearl® P3™ Professional Wet Core Bits for Granite

- Long life
- Vacuum brazed side protection
- 5/8-11 female thread
- Max 4,000 RPM
- Wet use only

Stock No.	Diameter	Price
600331	1 1/4".....	\$63.95
600332	1 3/8".....	71.35
600333	1 1/2".....	78.60
600334	2".....	90.95



Pro Series® Core Bit



- Formulated for fast cutting
- Includes vacuum brazed side protection
- Performance compares to any Premium segmented core bit
- 5/8-11 female thread
- Max 3,500 RPM
- Wet use only

Stock No.	Diameter	Price
800650	1".....	\$56.50
800651	1 1/4".....	61.50
800652	1 3/8".....	68.00
800653	1 1/2".....	76.50



Cyclone® Wet/Dry Core Bits for Granite

- Total length: 3", Cutting length: 2"
- 5/8-11 female thread
- Max 3,500 RPM
- Wet or dry use

Stock No.	Diam.	Price	Stock No.	Diam.	Price
600228	3/4".....	\$58.95	600230	2 1/2"....	\$105.95
600270	1".....	75.95	600231	2 3/4"....	109.95
600271	1 1/4".....	72.40	600285	3".....	119.95
600256	1 3/8".....	79.65	600232	3 1/2"....	125.95
600257	1 1/2".....	79.95	600233	4".....	139.95
600229	1 3/4".....	89.95	600234	4 1/2"....	151.95
600284	2".....	99.95	600235	5".....	165.95



ALPHA

Alpha® Core Bit

- 5/8-11 female thread
- Max RPM: 3500
- Wet use only

Stock No.	Diameter	Price
116171	3/8".....	\$85.85
116162	1/2".....	88.10
116169	3/4".....	88.10
116161	1".....	85.38
116164	1 1/4".....	97.66
116167	1 3/8".....	109.68
116165	1 1/2".....	120.75
116172	2".....	140.03



**Pro Series®
Thin Wall Core Bits**

- True Thin Wall Crown
- 5/8-11 female thread
- 2 5/8" Length
- Wet use only

Stock No.	Diam.	RPM Range	Price	Stock No.	Diam.	RPM Range	Price
300205	3/4"	3,375-4,500	\$61.50	300213	2"	2,250-3,000	\$95.50
300206	1"	3,000-4,000	66.00	300216	2 3/8"	1,725-2,300	105.50
300208	1 1/4"	2,850-3,800	72.50	300218	2 5/8"	1,275-1,700	116.50
300209	1 3/8"	2,625-3,500	79.00	300219	3"	750-1,000	147.00
300210	1 1/2"	2,551-3,400	83.00	300221	4"	335-450	161.50
300212	1 3/4"	2,475-3,300	89.50	300222	4 3/4"	240-325	212.00



GranQuartz
DIAREX®



**Diarex®
Continuous Rim
Core Bits**

- 5/8-11 female thread
- Wet use only

Stock No.	Diam.	Cutting Depth/ RPM Range	Price
116991	1/2"	4", 4,500-6,000	\$95.95
116994	5/8"	4", 3,750-5,000	95.95
117001	3/4"	4", 3,375-4,500	105.50
117004	7/8"	4", 3,150-4,250	102.95
117009	1"	4", 3,000-4,000	101.95
117015	1 1/8"	4", 2,925-3,900	103.45
117020	1 1/4"	4", 2,850-3,800	107.55
117026	1 3/8"	4", 2,625-3,500	115.95
117032	1 1/2"	4", 2,550-3,400	113.95
117036	1 5/8"	4", 2,500-3,350	116.95

Stock No.	Diam.	Cutting Depth/ RPM Range	Price
117046	2"	4", 2,250-3,000	\$134.50
100285	7/8"	1 1/2", 3,150-4,250	88.95
100276	1 1/8"	1 1/2", 2,925-3,900	97.95
100283	1 3/8"	1 1/2", 2,625-3,500	97.99
100282	1 5/8"	1 1/2", 2,500-3,350	103.45

**Diarex®
1/2" Gas Continuous Rim
Core Bits**

- 1/2" Gas male thread
- Wet use only

Stock No.	Diam.	Cutting Depth/ RPM Range	Price
117013	1 1/8"	1 1/2", 2,925-3,900	\$100.95
117018	1 1/4"	1 1/2", 2,850-3,800	113.95
117023	1 3/8"	1 1/2", 2,625-3,500	105.95
117030	1 1/2"	1 1/2", 2,550-3,400	115.95

**Diarex®
Segmented Core Bits**

- 5/8-11 female thread
- Wet use only

GranQuartz
DIAREX®



Stock No.	Diam.	Cutting Depth/ RPM Range	Price
117055	2 1/4"	4", 1,950-2,600	\$171.95
117048	2 3/8"	4", 1,725-2,300	172.95
117052	2 1/2"	4", 1,500-2,000	179.50
117061	2 3/4"	4", 1,000-1,350	196.50
117065	3"	4", 750-1,000	225.00
117072	4"	4", 325-450	299.95
117075	5"	4", 225-300	387.50
100294	2 1/4"	1 1/2", 1,950-2,600	180.00
100268	2 1/2"	1 1/2", 1,500-2,000	175.95

ALPHA®



**Alpha®
Ecoguard CD**

Alpha's NEW Ecoguard CD collection shroud contains water and dust when drilling (up to a 2 1/2" core bit). Can be used in either vertical or horizontal applications.

- Secures to surface with vacuum
- Keeps work area clean
- Wet or dry use

Stock No.	Product	Price
119076	Ecoguard CD	\$30.80

SEGMENTED, DRY DRILLING CORE BITS



Xpert Vacuum Stripe Dry Core Bit

- Durable and Strong Segments.
- Side plated for faster cuts and coring
- Wet or dry use
- 5/8-11 Female thread



Stock No.	Diam.	Price	Stock No.	Diam.	Price
361414	7/8"	\$47.95	361422	2"	\$85.95
361415	1"	53.15	361440	2 1/4"	89.95
361416	1 1/8"	59.65	361441	2 1/2"	104.80
361417	1 1/4"	64.95	361438	2 3/4"	107.95
361418	1 3/8"	69.50	361442	3"	115.50
361419	1 1/2"	78.35	361443	3 1/2"	129.80
361420	1 5/8"	72.95	361439	3 3/4"	123.95
361421	1 3/4"	79.10	361444	4"	129.95



Pro Series® Dry Core Bit

Pro Series® Turbo Core Bits are designed with turbo rim segments for extremely aggressive and clean cutting.

- Total length: 3", Cutting length: 1 7/8"
- 5/8-11 female thread
- Vacuum brazed side protection
- Max 8,000 RPM
- Wet or dry use

Tool Life	4 bars
Clean Cut	4 bars
Speed	4 bars
Plug Removal	4 bars



Stock No.	Diameter	Price
600280	1"	\$70.35
600281	1 1/4"	73.45
600282	1 3/8"	77.95
600283	1 1/2"	80.95



Pro Series® Dry Core Bit

- Ultra fast
- Clean cutting
- Max 12,000 RPM
- Wet or dry use
- 5/8-11 Female thread



Tool Life	4 bars
Clean Cut	4 bars
Speed	4 bars
Plug Removal	4 bars



Stock No.	Diameter	Price
600765	1"	\$63.95
600766	1 1/4"	72.95
600767	1 3/8"	78.95
600768	1 1/2"	88.95



Assassin® Wet/Dry Core Bits

- 10mm tall segments
- Thin segments for fast, clean cutting
- Vacuum brazed side protection
- 5/8"-11 female thread
- Max 6,500 RPM
- Wet or dry use

Tool Life	3 bars
Clean Cut	3 bars
Speed	3 bars
Plug Removal	3 bars



Stock No.	Diameter	Price
620070	1"	\$48.60
620071	1 1/4"	50.65
620072	1 3/8"	51.70
620073	1 1/2"	55.95



Hurricane® Dry/Wet Core Bits for Granite

- Precision drilling of granite, marble or any hard stone
- 5/8-11 female thread
- Max 6,500 RPM
- Wet or dry use



Stock No.	Diameter	Price
600241	1 1/4"	\$60.95
600242	1 3/8"	61.95
600243	1 1/2"	64.99



Cayenna Dry Core Bits

These laser welded turbo segmented bits are specially engineered for speed and long life. The vacuum brazed side protection offers a non-binding clean cut.

- 5/8"-11 female thread
- Max. 10,000 RPM
- Wet or dry use



Stock No.	Diameter	Price
361445	1"	\$39.95
361446	1 1/4"	54.95
361447	1 3/8"	59.95
361448	1 1/2"	64.95
361449	1 3/4"	67.95
361450	2"	69.95

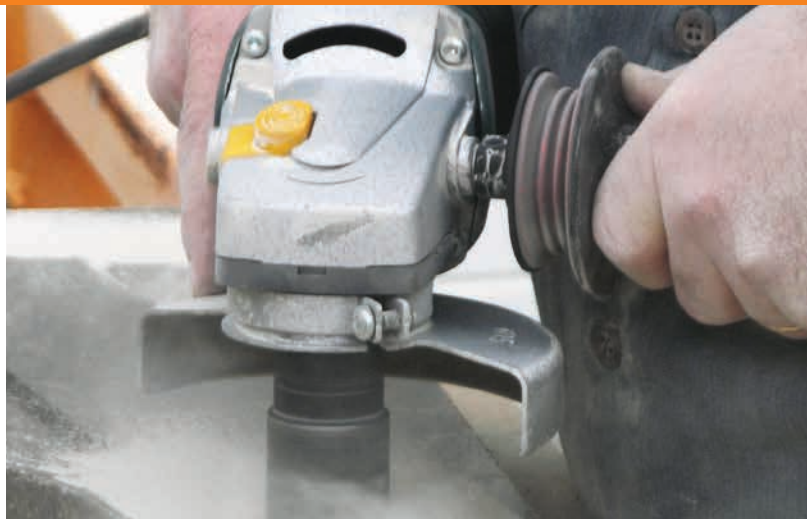

Zenesis® III Dry Core Bits

All-new design for enhanced performance with abrasive side coating for faster speed and large cooling holes on core.

- 5/8"-11 female thread
- For Granite and engineered stone
- Wet or dry use



Stock No.	Diameter	Price
370137	1 1/4"	\$82.50
370138	1 3/8"	85.50
370139	1 1/2"	86.50
370140	2"	98.00
370141	2 1/4"	106.00



Cyclone® T-Segment Dry Core Bits

Specially designed T-segment increases durability and minimizes segment loss.

- Perfect for use in the field when water is not an option
- 5/8"-11 female thread
- Max. 6,500 RPM
- Wet or dry use



Stock No.	Diameter	Price
679928	1 1/4"	\$76.50
679929	1 3/8"	79.00
679927	1 1/2"	82.50



Pearl® P5™ Dry Turbo Core Bits

Designed with ADM (Advanced Diamond Matrix) & high diamond concentration for extra long life with vacuum brazed protection outside and inside of core.

- Max 10,000 RPM
- Wet or dry use
- 5/8-11 female thread
- Extra coarse diamonds for aggressive cutting
- Laser welded



	Stock No.	Diameter	Price
Tool Life	990108	1 1/4"	\$73.45
Clean Cut	990109	1 3/8"	83.95
Speed	990110	1 1/2"	93.95
Plug Removal	990113	2"	103.95

PEARL



Alpha® Dry Core Bits

- 5/8-11 female thread
- Max 12,000 RPM
- Wet or dry use



Stock No.	Diameter	Price
116233	1/2"	\$97.15
116234	3/4"	100.27
116235	1"	97.23
116117	1 1/4"	98.13
116119	1 3/8"	110.40
116236	1 1/2"	123.73
116237	2"	141.54

ALPHA



Pearl® P4™ Dry Turbo Core Bits

Engineered with ADM™ (Advance Diamond Matrix) diamond pattern for cleaner cutting & long life and embedded segments for added durability.

- Extra long life
- Max 10,000 RPM
- Wet or dry use
- 5/8-11 female thread



Stock No.	Diameter	Price
990163	1 1/4"	\$67.20
990164	1 3/8"	71.35
990165	1 1/2"	81.95
990166	2"	91.95

PEARL



Blue Thunder Dry Core Bits

- Laser welded segments
- 5/8-11 female thread
- Max 8,000 RPM
- Wet or dry use



Tool Life	5 bars
Clean Cut	5 bars
Speed	5 bars
Plug Removal	5 bars

Stock No.	Diam.	Price
694473	1/2"	\$54.95
694480	5/8"	60.95
694479	3/4"	65.99
694470	1"	70.35
694472	1 1/4"	76.55
694475	1 3/8"	78.60
694471	1 1/2"	90.95
694474	1 3/4"	96.95
694476	2"	98.30
694477	2 1/2"	109.95
694478	3"	119.95

CONTINUOUS RIM, WET DRILLING



**Pro Series®
CNC Core Bits**

- 1/2 Gas connection
- Clean cutting
- True Thin Wall Crown
- Wet use only



Stock No.	Diameter	Price
927546	1 3/8" (35mm)	\$78.95
927547	1 1/2" (38mm)	82.95
927549	2" (50mm)	95.95



**ADI®
CNC Core Bits**



- Premium Italian made
- Ultra clean cutting
- 1/2 Gas connection
- Wet use only

Stock No.	Diameter	Price
926856	1" (25mm)	\$79.95
926857	1 1/8" (30mm)	82.95
926850'	1 1/4" (32mm)	88.95
926852	1 3/8" (35mm)	90.95
926854	1 1/2" (38mm)	98.95



**ADI® 3"
Black Diamond
CNC Core Bits**



- 1/2 Gas connection
- Ultra aggressive diamond matrix
- Wet use only

Stock No.	Inside Diameter	Suggested RPM	Price
929015	1 1/4" (32mm)	2,200-2,400	\$88.95
927097	1 3/8" (35mm)	2,000-2,200	90.95
927098	1 1/2" (38mm)	1,800-2,000	95.00
927077	2" (50mm)	1,500-1,800	121.00



**Cyclone
1/2 Gas Core Bit**



- Ultra fast
- 1/2 Gas connection
- Clean cutting
- Wet use only

Stock No.	Diameter	Price
600248	1 3/8" (35mm)	\$82.95
600249	1 1/2" (38mm)	89.95

SPECIALIZED CORE BITS



**Pro Series®
Vacuum Brazed Core Bits**

Designed with two vacuum brazed pads on the inside of the body and long cooling slots for efficient and easy core removal.

- For drilling ceramic, porcelain, and all natural stone materials
- 5/8"-11 female thread
- Wet or dry use



Stock No.	Diam.	Price	Stock No.	Diam.	Price
993578	9/16"	\$64.95	993583	1 3/8"	\$78.95
993579	3/4"	68.95	993584	1 1/2"	79.95
993580	1"	69.95	993585	1 3/4"	84.95
993581	1 1/8"	72.95	993586	2"	89.95
993582	1 1/4"	75.95			

**Pearl® P4™
Tile & Stone Core Bits**

Vacuum brazed bond for fast, clean and chip-free drilling of Ceramic Tile, Porcelain, Marble, Granite and Glass.

- Remove material plugs quickly, easily
- Use wet for best results
- 1" maximum cutting depth
- 1/4" quick change hex shank
- Max 2,500 rpm



PEARL

Stock No.	Description	Price
677550	CDP3-16, 3/16 x 1/4	\$15.40
677551	CDP1-4, 1/4 x 1/4	15.70
677552	CDP9-32, 9/32 x 1/4	16.50
677553	CDP5-16, 5/16 x 1/4	17.40
677554	CDP3-8, 3/8 x 1/4	18.35
677555	CDP1-2, 1/2 x 1/4	19.70
677556	CDP5-8, 5/8 x 3/8	21.10



**Pro Series® Non-Coring
Vacuum Brazed Bits**

- For drilling ceramic, porcelain, marble and most other natural stone surfaces
- Fast, clean drilling
- 5/8"-11 female thread
- Wet or dry use



Stock No.	Diameter	Price
993573	3/16"	\$56.95
993574	1/4"	57.95
993575	5/16"	58.95
993576	3/8"	59.95
993577	1/2"	62.95



**Cyclone®
Porcelain Tile Bits**



Cyclone® Porcelain Tile Bits are the first dry bit for drilling porcelain, with a sintered turbo rim for faster cutting and long life.

- Includes hexagonal chuck connection
- Max 2,000 RPM
- Wet or dry use

Stock No.	Diameter	Price
600778	3/16"	\$23.98
600777	1/4"	23.38
600889	5/16"	23.95
600888	3/8"	25.65
600776	1/2"	26.78



Dust and Silica Warning See Inside Front Cover

California residents see Prop 65 warnings www.P65Warnings.ca.gov

SPECIALIZED CORE BITS



Pearl® P3™ Tile/Stone Drill Bits

PEARL

- Vacuum brazed bond for fast, clean, chip-free drilling
- Long life
- Designed with core removal slot
- Designed to drill holes in tile, porcelain and stone
- Wet use only

Stock No.	Diameter	Shank	Price
990148	1/4"	3/8"	\$12.94
990149	5/16"	3/8"	14.12
990150	3/8"	3/8"	15.26
990151	1/2"	3/8"	17.66
990152	9/16"	3/8"	20.05



Pro Series® Blind Hole Bits

- 1/2 Gas male thread
- Bit length: 50mm
- Wet use only



Stock No.	Diameter	Price
052546	1/4"	\$43.00
115154	6mm	43.45
115155	8mm	47.60
115156	10mm	52.75
115157	12mm	57.95
115158	14mm	61.95



Cyclone® Non-Coring Bits

New dry segment matrix allows these non-core drill bits to perform under high heat conditions.

- Wet or dry use
- 5/8"-11 female thread
- Max. 2,000 RPM



Stock No.	Diameter	Price
600210	3/16"	\$41.95
600237	1/4"	53.95
693820	3/8"	53.95

Alpha® Electroplated Diamond Drill Bits

ALPHA

Premium electroplated bits for drilling fastening holes, corner holes for cut-outs, pipe & faucet holes. Cuts clean, smooth holes.

- Wet use only
- Use on granite, ceramic, marble, porcelain and glass surfaces

Stock No.	Diameter	Shank	Price
101322	3/16"	3/8"	\$12.59
101323	1/4"	3/8"	13.43
101324	5/16"	3/8"	16.84
101325	3/8"	3/8"	18.77
101326	1/2"	3/8"	19.01
101327	13/8"	3/8"	44.06
101328	Adapter: 3/8" to 5/8"-11		21.99

GranQuartz
PRO
Series

Pro Series® Blind Hole Bits

High quality marble and granite bits with center waterfeed.

- 5/8"-11 female thread
- Bit length: 50mm
- Wet use only

Stock No.	Diameter	Price
116200	6mm	\$49.65
052547	1/4"	43.00
116201	8mm	50.65
116202	10mm	51.70
116209	12mm	54.95
116206	14mm	59.95

Pearl® P3™ General Purpose Dry Core Bits w/Pilot

PEARL

Fast cutting, long life, includes pilot and shaft.

- 1,200 Max RPM
- Wet or dry use
- 5/8" Shank

Stock No.	Diameter	Price
800129	1"	\$59.95
116513	1 1/4"	61.95
116514	1 3/8"	61.95
116515	1 1/2"	69.35
800128	2"	82.95



Multi-Purpose Drill Bits

Cobalt and tungsten carbide tipped bits designed for maximum hardness and resistance to heat and wear.

Stock No.	Diam.	Length	Shank	Price
340110	1/8"	3"	1/8"	\$4.80
340114	3/16"	3 1/2"	3/16"	5.10
340118	1/4"	4 1/8"	1/4"	5.70
340124	5/16"	4 1/2"	5/16"	6.18
340129	3/8"	5 3/16"	3/8"	8.22
340134	7/16"	6 3/8"	7/16"	10.02
340138	1/2"	6"	3/8"	14.95
340141	5/8"	9"	3/8"	25.65



Tonar Westa Tungsten Carbide Drill Bits

Heavy duty stone drill bits with specially shaped dust removal spiral.

Stock No.	Diameter	Length	Price
115954	5mm	85mm	\$5.95
115955	6mm	100mm	7.44
115956	7mm	100mm	7.44
115957	8mm	120mm	9.05

GranQuartz
DIAREX®



Diarex® Dressing Blocks

Use of dressing blocks will restore worn diamond tool's performance. 6" Diameter x 2 1/2" thickness.

Stock No.	Grit	Price
910068	Coarse	\$21.19
910069	Medium	23.54

GranQuartz
DIAREX®



Drill wet even when using a dry tool!

Diarex® Drilling Suction Cups

Serves as a water reservoir, allowing wet drilling when a water supply is not readily available.

Stock No.	Inside Diameter	Price
800492	1 5/8"	\$11.35
800493	2 5/8"	14.45

Core Drilling Adapters

Reusable adapters allow standard core bits to fit most machines.



#	Stock No.	Adapts From:	To:	Price	Stock No.	Adapts From:	To:	Price
#116988	910045	1/2 Gas male	5/8" - 11 male	\$45.70	910065	5/8" - 11 Female	1/2 Gas female thread	\$54.95
#810045	910046	1/2" Gas male	Ghines male	43.65	920066	5/8" - 18 male	1/2 Gas female	65.00
	116988	5/8" Male x 9mm Drill Shank	5/8" - 11 male	37.40	912113	5/8" - 18 male	5/8" - 11 male	66.50
	903600	1/2" Male shaft	Ghines male	39.45	117086	M-12 female	5/8" - 11 male	39.95
	910064	5/8" - 11 Female	Ghines male	61.46	117085	5/8" - 11 female	M-12 male	44.65



Water Rotor Coupling

Allows a dry power tool to drive wet cutting bits and wheels requiring central waterfeed

Stock No.	Description	Price
116100	1/2" shaft x 5/8"	\$110.00

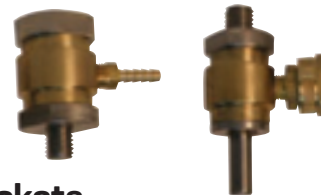

Water Jackets for Center Water Feed Tools

1/4", 1/2" and garden hose connections

Stock No.	Description	Price
912150	1/2" shaft to 5/8"- 11 w/ 1/4" hose connection	\$164.30
912152	1/2" shaft to 5/8"- 11 w/ garden hose connection	171.40
912153	5/8"- 11 fem. to 5/8"- 11 w/ 1/4" hose connection	172.90
912155	5/8"- 11 fem. to 5/8"- 11 w/ garden hose connection	181.40

The Tornado Grinding System Is A GREAT SOLUTION For Shops Moving To WET Grinding!

TORNADO GRINDING WHEEL SYSTEM

Tornado grinding wheels are the smoothest running and cleanest cutting grinding wheels available. Made in Germany to exacting standards, Tornado wheels deliver a superb balance of grinding performance and long tool life. Available in a full sequence from 36-320 grit, Tornado wheels allow you to remove as much or as little material as required.

Tornado wheels have been specially engineered for long life and proven in extensive tests to last as long as 40 standard 4" silicon carbide wheels.

- Safer than silicon carbide bricks and dust free when used wet
- Precision balanced for silky smooth grinding
- Aggressive grinding action
- Extra long life
- Available in four styles for a variety of grinding applications
- Max 4,000 RPM

Tornado Accessories

- Magnet holds tool firmly in place, while allowing quick and easy tool change



Stock No.	Description	Price
115885	5/8" Thread	\$187.59
115886	Tornado Adapter 5/8"-11" No Cushion	165.00

Add with Magnetic Couplers

115884	Felt Polishing wheel	\$42.95
--------	----------------------------	---------

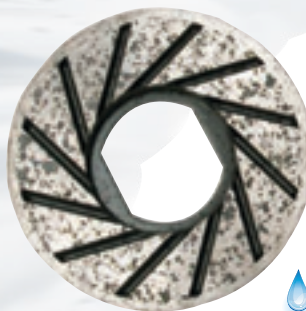

Rigid 4" Wheels

The Tornado Rigid is a multi-purpose grinding wheel, perfectly suited for edge work and many other grinding applications.

- Wet Use
- Combine with Tornado Sicarex bricks or Polishing Pads for final polishing
- 4" Diameter

Stock No.	Description/Grit	Price
115876	T-0 Black, 36	\$195.95
115879	T-1 Red, 120	195.95
115881	T-2 Yellow, 220	195.95
115883	T-3 Green, 320	195.95



Flexible 4" Wheels

The inclusion of rubber gives the wheel a semi-flexible design that is suitable for sink work and other areas with tight radiuses.

- Wet Use
- Combine with Tornado Sicarex bricks or Polishing Pads for final polishing

Stock No.	Description/Grit	Price
115892	4" T-1 Red, 36	\$196.95
115893	4" T-2 Yellow, 220	196.95
115894	4" T-3 Green, 320	195.95

SEGMENTED CUP WHEELS



Aluminum Body Cup Wheels

Perfectly balanced to eliminate chipping and provide smooth grinding and shaping. The body is made of aluminum, a softer metal which reduces chattering and absorbs the "bounce" associated with stock removal.

- Lightweight aluminum body
- Use for grinding and stone edge prep/shaping
- Works great on granite
- Wet or dry use
- 5/8" – 11 Female arbor

Stock No.	Description	Max. RPM	Price
361786	2", Coarse, Rival®	13,700	\$49.95
920666	4", Coarse, Pro Series®	13,700	79.95
920667	4", Medium, Pro Series®	13,700	79.95
920668	4", Fine, Pro Series®	13,700	79.95
920670	6", Coarse, Pro Series®	10,000	95.95
920669	4", CONVEX Coarse, Pro Series®	13,700	109.95

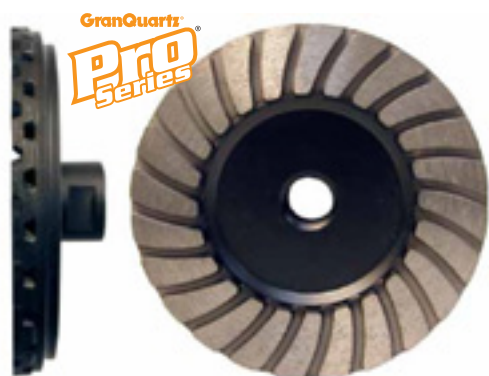

Pro Series® Cup Wheels

- 5/8" – 11 Female arbor
- Wet or dry use
- Designed for professional performance

Stock No.	Description	Max. RPM	Price
800341	4" Coarse	13,700	\$82.95
800342	4" Medium	13,700	82.95
800360	4" Fine	13,700	82.95
115707	5" Coarse, CONVEX	12,200	92.95
800621	6" Coarse, Flat	10,000	103.45
800571	6" Coarse, CONVEX	10,000	103.45
800343	7" Coarse	8,500	134.50
115708	7" Coarse, CONVEX	8,500	134.50



Legend® 4" Cup Wheels

- Aluminum body
- 5/8" – 11 Female arbor
- Wet or dry use
- Premium, Italian-made cup wheels

Stock No.	Description	Max. RPM	Price
118183	Extra Coarse	13,700	\$102.95
118515	Coarse	13,700	102.95
118516	Medium	13,700	102.95
118518	Fine	13,700	102.95



Pearl® P4™ 4" Cup Wheels

- Extra long life
- Turbo design for fast, smooth grinding
- For use on a variety of material
- Wet or dry use
- 5/8" – 11 Female arbor

Stock No.	Description	Max. RPM	Price
600314	Coarse	13,700	\$88.95
600315	Medium	13,700	88.95



Cyclone® Cup Wheels

- Wet or dry use
- 5/8" - 11 Female arbor

Stock No.	Description	Max. RPM	Price
115700	4" Coarse	8,000	\$85.95
115701	4" Medium	8,000	85.95
115702	5" Coarse	7,500	97.95
115703	6" Coarse	6,000	119.95
115704	7" Coarse	5,500	135.95



Hurricane Turbo 4" Cup Wheels

- Excellent value, aggressive
- Wet or dry use
- Aluminum body
- 5/8" – 11 Female arbor

Stock No.	Description	Max. RPM	Price
920591	4" Coarse	8,000	\$75.50
920592	4" Medium	8,000	75.50
920593	4" Fine	8,000	75.50

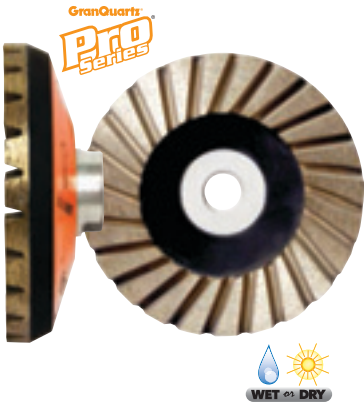

Pro Series® Silent Cup Wheels

- Unique rubber body minimizes vibrations
- Smooth, chip-free grinding
- Quiet operation, very light weight
- 5/8"-11 Female arbor
- Wet or dry use

Stock No.	Description	Max. RPM	Price
993186	4" Coarse	13,700	\$99.95
993187	4" Medium ...	13,700	99.95
993188	4" Fine.....	13,700	99.95
993715	5" Coarse	12,200	119.95
993825	5" Medium ...	12,200	119.95
993824	5" Fine.....	12,200	119.95



Assassin® 4" Cup Wheels

Excellent value, aggressive wet or dry cutting and grinding.

- 5/8"-11 Female arbor
- Wet or dry use

Stock No.	Description	Max. RPM	Price
115716	Coarse.....	13,700	\$64.99
115717	Medium.....	13,700	64.99



PEARL



Pearl® P5™ CupWheels

Designed to be used on a variety of materials, with high diamond concentration for extra long life & turbo design for fast, smooth grinding.

- 5/8"-11 Female arbor
- Wet or dry use

Stock No.	Description	Max. RPM	Price
115777	4" Coarse.....	13,700	\$165.00
115773	4" Medium.....	13,700	150.00
115771	4" Fine	13,700	150.00
115782	6" Coarse.....	10,000	287.00
115785	7" Coarse.....	8,500	295.00



Dongsin® 4" Turbo Rounder Cup Wheel

Dongsin Turbo Rounder Cup Wheels are for grinding and honing granite and marble surfaces.

- Swirl-Slot design for dust discharge and enhanced cooling
- 5/8"-11 Female arbor
- For Granite and marble
- Wet or dry use

Stock No.	Description	Max. RPM	Price
122128	4" Coarse	10,000	\$102.95
122127	4" Medium	10,000	102.95
122126	4" Fine.....	10,000	102.95



Black Magic® 4" D-Fiber Cup Wheels

Low vibration reduces chipping and the proprietary "tread" pattern provides a consistent run with just the right amount of aggressiveness. Very lightweight, one of the best grinding/shaping wheels on the market.

- 5/8"-11 Female arbor
- Use on UCS, Engineered Stone, Granite & Porcelain
- Wet or dry use

Stock No.	Description	Max. RPM	Price
800710	Coarse Grit.....	13,700	\$89.95
800709	Medium Grit.....	13,700	89.95
800708	Fine Grit.....	13,700	89.95



Gold Series Cup Wheels

- Available in Turbo or Double Row type
- Wet or dry use

Stock No.	Description	Max. RPM	Price
698423	4" Turbo, Coarse.....	13,700	\$87.10
698425	4" Turbo, Fine.....	13,700	82.95
698424	4" Turbo, Medium.....	13,700	82.95
698426	7" Turbo, Coarse.....	8,500	154.95
698427	7" Turbo, Fine.....	8,500	154.95
698428*	7" Double Row, Coarse ...	8,500	154.95
698429	7" Double Row, Coarse ...	8,500	164.95

*#698428 has a 7/8" Center Hole, non-threaded arbor

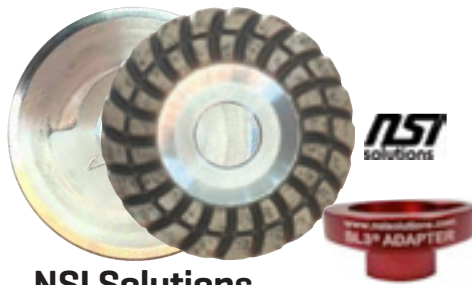

NSI Solutions SL3® Cup Wheel

Use for heavy, quick stock removal. Fits NSI Solutions' SL3 Adapter.

- Snail Lock attachment
- Available in Fine, Medium and Coarse grit

Stock No.	Description	Price
790436	3", Coarse Grit.....	\$89.00
790459	3", Medium Grit.....	89.00
790460	3", Fine Grit.....	89.00
790405	Adapter.....	49.95



Cyclone® 4" Ultra Mesh Cup Wheel

A very lightweight, smooth running cup wheel for miter cleanup & shaping granite, porcelain or engineered stone surfaces with minimal vibration.

- 5/8"-11 Female arbor
- Wet use only

Stock No.	Description	Max. RPM	Price
115503	Coarse Grit.....	13,700	\$99.95
115502	Medium Grit.....	13,700	99.95
115501	Fine Grit.....	13,700	99.95



PEARL

Pearl® P4™ Button Cup Wheels

- Great for removing mastic, resin or meshing
- Grinds Concrete, Stone and other hard materials
- Steel body with fixed 5/8"-11 Thread
- Wet or dry use

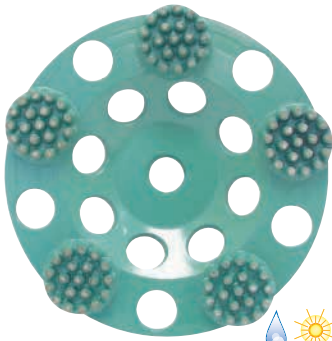

Stock No.	Diam.	Max. RPM	Price
933510	4"	13,700	\$79.95
933511	5"	12,200	105.95
933512	6"	10,200	135.95
933513	7"	8,500	155.95



Dongsin® 4" GMB™ Remover

- 5/8"-11 Female arbor
- Wet or dry use

Stock No.	Description	Max. RPM	Price
122096	60 Grit	8,000	\$119.95
122093	100 Grit	8,000	119.95
122094	200 Grit	8,000	119.95



Cyclone® Super Cluster Grinding Wheel

- For granite and concrete
- Designed for rapid removal of mesh backings, epoxy coatings, paint, rust and all adhesive materials
- Leaves smooth finish for easy surface prep
- 5/8"-11 Female arbor
- Wet or dry use

Stock No.	Description	Max. RPM	Price
933504	4" Medium	13,200	\$69.95
933506	5" Medium	12,200	99.95
933508	7" Medium	10,000	149.95

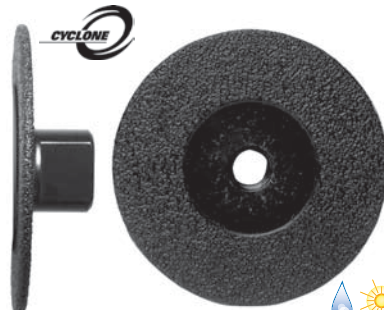

Cyclone® V1 Vacuum Brazed Cup Wheels

- Vacuum brazed
- Wet or dry use
- 5/8"-11 Female arbor

Stock No.	Description	Max. RPM	Price
115710	4" 30/40 Grit	9,000	\$99.95
115711	4" 50/60 Grit	9,000	99.95
115712	5" 30/40 Grit	8,000	116.95
170327	5" 50/60 Grit	8,000	116.95

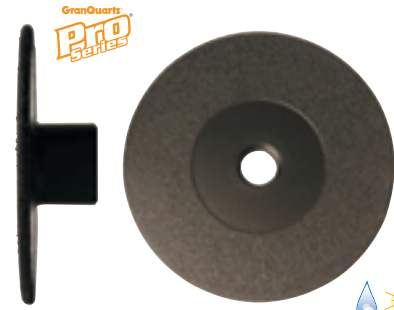

Pro Series® Vacuum Brazed Cup Wheels

- Wet or dry use
- 5/8"-11 Female arbor
- Light weight, compact design makes this an excellent alternative to silicon carbide bricks
- Diamond surface wraps around the tool's edge

Stock No.	Description	Max. RPM	Price
115842	4" Coarse	10,000	\$93.95
115843	4" Medium	10,000	93.95
993750	4" Fine	10,000	93.95



Assassin® Vacuum Brazed Cup Wheels

- Vacuum brazed Turbo Segment for aggressive grinding
- Rubber backer reduces weight and vibration
- 5/8"-11 Female arbor
- Wet or dry use

Stock No.	Description	Max. RPM	Price
914223	4" Coarse	5,000	\$51.70
914224	4" Medium	5,000	51.70
914225	4" Fine	5,000	51.70



Pro Series® Combo Wheel

- Combination cutting & grinding wheel
- 5/8"-11 Female arbor
- Wet or dry use
- Longer life alternative to flat body wheels
- For shaping, feathering, notching, bevelling and precision grinding

Stock No.	Description	Max. RPM	Price
899233	4", Coarse	13,700	\$61.95
899234	4 1/2", Coarse	13,700	72.95
899235	5", Coarse	12,200	82.95



Surface Pro® Gold Diamond Brazed Cup Wheels

Vacuum brazed diamond cup wheels designed to quickly remove fiberglass mesh, paint, epoxy, and other thick materials while leaving a smooth finish.

- Coarse Grit
- 5/8"-11F arbor
- 5" Cup wheel Max RPM: 12,200
- 7" Cup wheel Max RPM: 8,600
- Wet or dry use

Stock No.	Description	Price
001108	5", Coarse	\$79.00
001109	7", Coarse	99.95



Black Magic® Diamond-Resin Cup Wheel

For true chip-free beveling. Utilizing RGT technology, Black Magic DRC wheels have the feel of a polishing pad, lightweight and very smooth cutting, but are as aggressive as a diamond cup wheel. For wet or dry use beveling natural stone, porcelain, UCS material and removing mesh backings.

- Aluminum backed with 5/8"-11 Female arbor

Stock No.	Natural Stone	Price	Stock No.	USC/ Porcelain	Price
637512	30 Grit.....	\$39.95	637514	100 Grit.....	\$39.95
637513	50 Grit.....	39.95	637515	200 Grit.....	39.95



Cyclone® 4" Hex Flat Resin-Filled Cup Wheel

Flat, 90° surface gives a smoother feel when grinding and allows for easier corner shaping.

- 5/8"-11 Female arbor
- Use on Dekton, Engineered Stone and Granite
- Wet or dry use

Stock No.	Description	Price
115676	4", Coarse.....	\$82.95
115677	4", Medium.....	82.95
115678	4", Fine.....	82.95

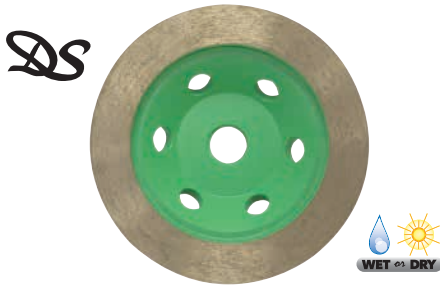

Dongsin® 4" Continuous Rim Cup Wheel

- For grinding, chamfering
- 5/8"-11 Female arbor
- Wet or dry use
- Continuous diamond prevents chipping and cracking

Stock No.	Description	Max. RPM	Price
122158	4" Coarse.....	8,000	\$99.95
122159	4" Medium.....	8,000	99.95
122160	4" Fine.....	8,000	99.95



Diarex® 4" Resin-Filled Cup Wheel

Designed with 16 high quality metal segments surrounded by a smooth resin for supreme quality with no bouncing, vibrating or chipping.

- For Granite, Marble and Engineered Stone
- 5/8"-11 Female arbor
- Wet or dry use

Stock No.	Description	Max. RPM	Price
993752	4" Coarse.....	8,000	\$99.95
993753	4" Medium.....	8,000	99.95
993754	4" Fine.....	8,000	99.95



Dongsin® Resin-Filled Cup Wheel

Designed for smooth, chip free grinding with no bouncing or chipping.

- 5/8"-11F arbor
- 4" Cup wheel Max RPM: 8,000
- 5" Cup wheel Max RPM: 6,500
- Bevelled edges for smooth surface grinding
- Wet or dry use

Stock No.	Description	Price
123350	4", 100 Grit.....	\$91.50
123351	4", 200 Grit.....	91.50
123354	5", 200 Grit.....	123.95



Pro Series® Resin Filled Cup Wheels

- Resin filled, for smooth, chip-free grinding
- 5/8"-11 Female arbor
- Wet or dry use

Stock No.	Description	Max. RPM	Price
993770	4" Coarse.....	8,000	\$91.95
993771	4" Medium.....	8,000	91.95
993772	4" Fine.....	8,000	91.95



Cyclone® Resin-Filled Cup Wheel

Beveled edge on cup face allows the tool to glide along surface preventing surface damage. 12 Grinding segments.

- 5/8"-11 Female arbor
- Wet or dry use

Stock No.	Description	Max. RPM	Price
115689	4" Coarse.....	8,000	\$82.95
115688	4" Medium.....	8,000	82.95
115687	4" Fine.....	8,000	82.95



Pearl® P4™ Supreme Dry 4" Shaping Wheel

- Resin filled space between diamond segments prevents vibration and chipping
- For light grinding on granite and marble
- 5/8"-11 Female arbor
- Wet or dry use

Stock No.	Description	Max. RPM	Price
112365	Coarse.....	8,000	\$89.00
694758	Medium.....	8,000	89.00
694759	Fine.....	8,000	89.00

GranQuartz
DIAREX®



Diarex® Threaded Grinding Wheels

- Dry grinding on marble or granite
- 5/8" – 11 female thread
- Maximum RPM : 14,500
- 2" outside dimensions x 2" tall

Stock No.	Grit	Price
960060	24	\$10.49
960062	46	10.49
960064	60	10.49
960066	120	11.69
960068	220	11.69

Pro Series®
Green Grinding Wheels

- Dry grinding on marble or granite
- 5/8" – 11 female thread
- Maximum RPM 4" : 9,070
5" : 7,258
- Available in 4" or 5" diameter

Order in multiples of 5 [same grit] and save 15%!



Stock No.	Diam.	Grit	Price
960000	4"	24	\$21.08
960002	4"	36	21.08
960004	4"	46	22.22
960006	4"	60	22.22
960008	4"	80	23.43
960010	4"	120	23.43

Stock No.	Diam.	Grit	Price
960012	4"	150	\$33.00
960014	4"	180	33.00
960016	4"	220	33.00
960018	4"	240	39.84
960020	4"	280	39.84
960022	4"	320	39.84

Stock No.	Diam.	Grit	Price
960100	5"	24	\$30.50
960102	5"	36	30.50
960104	5"	46	30.50
960106	5"	60	30.50
960108	5"	80	30.50
960110	5"	120	30.50
960114	5"	180	41.15
960116	5"	220	46.91



Grinding Wheel Dresser with Handle

Stock No.	Description	Price
101300	Model #0 Dresser w/handle	\$20.55
101303	Spare Roll, 1 1/4 x 1/4" Box of 10	20.10
101301	Model #1 Dresser w/handle	25.70
101304	Spare Roll, 1 1/2 x 1/2" Box of 10	26.95
696208	Model #2 Dresser w/handle	36.95
696189	Spare Roll, 2 3/8 x 19/32" Each	6.79

Sicarex-Tornado Silicon Carbide Grinding/Polishing Stones

Use with waterfed angle grinders on granite, marble and engineered stone surfaces. Sicarex-Tornado Grinding/Polishing Stones are fitted with metal attachment plate for compatibility Tornado 1 Magnetic Coupling (#115885) with 5/8" - 11 Female connection.

- Long service and shelf life
- Insensitive to moisture
- 105mm diameter x 40mm thick
- 12 per case
- Recommended RPM: 2000



Stock No.	Description	Grit	Price/Ea.
115896	#1 Preliminary Grinding	36	\$10.29
115897	#2 Medium Grinding	120	11.05
115898	#3 Fine Honing	320	11.05
115899	#4 Fine Honing	600	15.05
115900	#5 Fine Honing	800	16.85
115901	Final Buffer/Granite	n/a	31.59
115885	Adapter	n/a	187.59



Assassin®
Black Silicon Carbide Grinding Wheels

Performance at a value price for dry grinding on marble or granite.

- 5/8" - 11 female thread
- Maximum RPM 4" - 9,070

Stock No.	Size	Grit	Price
696302	4" x 2"	16	\$12.87
960130	4" x 2"	24	11.73
960131	4" x 2"	36	11.73
960132	4" x 2"	46	11.73
960133	4" x 2"	60	11.73
960134	4" x 2"	80	11.73
960135	4" x 2"	120	11.73
696309	4" x 2"	220	11.73
696311	5" x 2"	24	14.01
696312	5" x 2"	36	14.01
696322	5" x 2"	60	14.01
696323	5" x 2"	80	14.01
696313	5" x 2"	120	14.01

Stock No.	Size	Grit	Price
696277	1.5" x 3"	24	\$10.55
696278	1.5" x 3"	36	10.55
696280	1.5" x 3"	80	9.98

FLARED Wheels

696124	4" x 2"	36	\$10.49
696126	4" x 2"	80	10.49
696130	5" x 2"	36	14.35
696132	5" x 2"	80	14.35

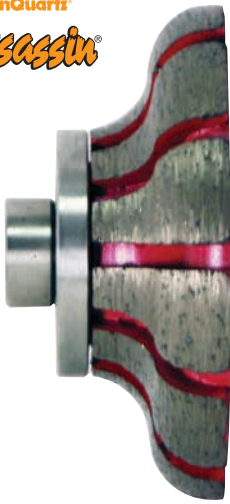

Assassin® Router Bits

- Fast, clean cutting and long life
- Available in many shapes and sizes
- Continuous Rim and Segmented bits

Form A • 2cm

103696 Pos. 1 \$199.45

Form B • 2cm Segmented

103690 Pos. 1 \$188.95

Form E • 2cm

103698 Pos. 1 \$199.45

Form E • 2cm Segmented

103691 Pos. 1 \$199.50

Form F • 2cm

103699 Pos. 1 \$199.45
103700 Pos. 2 199.45

Form F • 2cm Segmented

103692 Pos. 1 \$199.50

Form F • 3cm

103701 Pos. 1 \$225.75
103702 Pos. 2 225.75

Form F • 3cm Segmented

103693 Pos. 1 \$220.50

Form V • 3cm

103703 Pos. 1 \$314.95

Form V • 3cm Segmented

103694 Pos. 1 \$304.45

Form V • 4cm Segmented

103695 Pos. 1 \$331.75

Router Bit Bearings-Open Profiles

650294 40MM, Pos. 1 Bearing for Open Profiles \$33.60
800537 40MM, Pos. 2 Bearing for Open Profiles 33.60

Router Bit Bearings- Closed Profiles

800538 40MM, Pos. 1 Bearing for Closed Profiles \$33.60
950293 41MM, Pos. 2 Bearing for Closed Profiles 33.60

Assassin® Fragmented Router Bits

Assassin® Fragmented Router Bits are manufactured through a unique process where plastic injection molding is combined with a diamond tip in a fragmented state. The results are a lightweight profiling tool with exceptional cutting speed that keeps a consistently uniform shape throughout its life.

- Exceptional Cutting Speed
- Maintains shape integrity
- Economical Option

Stock No.	Description	Price
697820	Form B, 2CM Pos.1	\$199.95
697821	Form E, 2CM Pos.1	199.95
697822	Form F, 2CM Pos.1	199.95

Stock No.	Description	Price
697825	Form B, 3CM Pos.1	\$265.00
697827	Form F, 3CM Pos.1	265.00
697828	Form V, 3CM Pos.1	315.00



Fragmented Router Bit Bearings-Open Profiles

993558 Bearing for Open Profiles \$16.50

Fragmented Router Bit Bearings- Closed Profiles

993559 Bearing for Closed Profiles \$12.00



ADI® UHS® ROUTER BITS

ADI is the world's premier manufacturer of diamond tools for the stone market, with an unparalleled knowledge of industrial diamond applications. Continuous research, development investments and close alliances with leading stone-working machinery manufacturers keep ADI at the forefront of the Industrial Diamond industry.

**ULTRA
AGGRESSIVE
MATRIX!**

**Rubber Bits
4,000
MAX RPM!**

GranQuartz offers a full line of ADI router tools. All profiles and sizes are available, and common profiles and sizes are stocked.

GranQuartz matches the best selection of high quality tools and equipment with the most knowledgeable sales force in the stone industry and the largest inventory of diamond tooling in North America.

UHS® Router Bits from ADI® are the "gold standard" in the stone fabrication world. UHS bits are the FASTEST profiling bits available, formulated using an EXTRA AGGRESSIVE diamond matrix for ultra fast stock removal.

Form A • 2cm

941740 ADI Pos. 00..... Metal w/Toucher.....\$235.00

Form A • 3cm

941760 ADI Pos. 00..... Metal w/Toucher.....\$301.00
941765 ADI Pos. 2..... Metal w/Toucher.....301.00

Form B • 2cm

941905 ADI Pos. 00..... Metal w/Toucher.....\$265.00
941910 ADI Pos. 2..... Metal w/Toucher.....265.00

Form B • 3cm

941720 ADI Pos. 00..... Metal w/Toucher.....\$350.00
941725 ADI Pos. 2..... Metal w/Toucher.....350.00

Form B+B • 3cm

941750 ADI Pos. 00..... Metal w/Toucher.....\$599.00
941755 ADI Pos. 2..... Metal w/Toucher.....599.00

Form E • 2cm

941770 ADI Pos. 00..... Metal w/Toucher.....\$329.00

Form E • 3cm

941780 ADI Pos. 00..... Metal w/Toucher.....\$412.00

Form F • 2cm

941700 ADI Pos. 1..... Metal w/Toucher.....\$365.00
941705 ADI Pos. 2.....Metal w/Bearing.....365.00

Form F • 3cm

941710 ADI Pos. 00..... Metal w/Toucher.....\$496.00
941715 ADI Pos. 2.....Metal w/Bearing.....496.00

Form F+S • 3cm

942065 ADI Pos. 00..... Metal w/Toucher.....\$787.00
942070 ADI Pos. 2..... Metal w/Toucher.....787.00

Form F+V • 3cm

940336 ADI Pos. 00..... Metal w/Toucher.....\$782.00
942097 ADI Pos. 2..... Metal w/Toucher.....782.00

Form F+V • 4cm

942045 ADI Pos. 00..... Metal w/Toucher.....\$807.00

Form F+Z • 3cm

941915 ADI Pos. 00..... Metal w/Toucher.....\$429.00
941920 ADI Pos. 2..... Metal w/Toucher.....429.00

Form H • 2cm

941790 ADI Pos. 00..... Metal w/Toucher.....\$343.00
941795 ADI Pos. 2..... Metal w/Toucher.....343.00

Form H • 3cm

941840 ADI Pos. 00..... Metal w/Toucher.....\$416.00

Form L • 2cm

941945 ADI Pos. 00..... Metal w/Toucher.....\$425.00

Form L • 3cm

941850 ADI Pos. 00..... Metal w/Toucher.....\$504.00

Form O • 2cm

941955 ADI Pos. 00..... Metal w/Toucher.....\$553.00

Form O • 3cm

942005 ADI Pos. 00..... Metal w/Toucher.....\$672.00

Form Q • 3cm

942015 ADI Pos. 00..... Metal w/Toucher.....\$714.00
942020 ADI Pos. 2..... Metal w/Toucher.....714.00

Form SM • 3cm

941965 ADI Pos. 00..... Metal w/Toucher.....\$535.00
941970 ADI Pos. 2..... Metal w/Toucher.....535.00

Form T • 3cm

941985 ADI Pos. 00..... Metal w/Toucher.....\$535.00

Form V • 2cm

942035 ADI Pos. 00..... Metal w/Toucher.....\$375.00

Form V • 3cm

941690 ADI Pos. 00..... Metal w/Toucher.....\$415.00
941695 ADI Pos. 2..... Metal w/Toucher.....415.00

Form V • 4cm

941730 ADI Pos. 00..... Metal w/Toucher.....\$516.00
941735 ADI Pos. 2..... Metal w/Toucher.....516.00

Form V • 6cm

941890 ADI Pos. 00..... Metal w/Toucher.....\$937.00

Form Z • 4cm

941995 ADI Pos. 00.....Metal w/toucher.....\$429.00
942000 ADI Pos. 2.....Metal w/toucher.....429.00

Form Z+S • 3cm

941935 ADI Pos. 00.....Metal w/ Toucher.....\$421.00

Router Bit Bearings-Closed Profiles

940801 40MM, Pos. 00..... Bearing for Closed Profiles.....\$47.95
940802 40MM, Pos. 2..... Bearing for Closed Profiles.....47.95

Router Bit Bearings-Open Profiles

940803 41MM, Pos. 00..... Bearing for Open Profiles.....\$29.95
940804 40MM, Pos. 2..... Bearing for Open Profiles.....29.95



Legend® Diamond Router Bits

- Fast, clean cut and long life
- Available in many shapes and sizes
- Will not bounce, chatter or vibrate during use

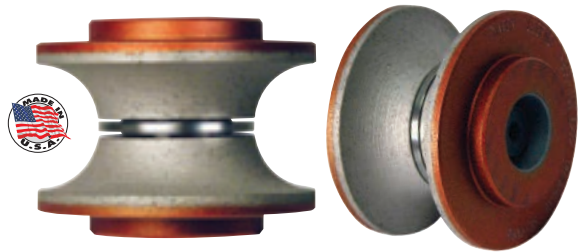

Form A • 3cm R=10

117957	Pos. 1.....Round over...	\$289.00
690346	Pos. 2.....Round over.....	289.00

Form B • 3cm R=25

690326	Pos. 1.....Demi bull.....	\$445.00
690309	Pos. 2.....Demi bull.....	445.00

Form B+B • 3cm

690358	Pos. 1.....Waterfall.....	\$495.00
690357	Pos. 2.....Waterfall.....	495.00

Form B+B • 4cm

690366	Pos. 1.....Waterfall....	\$1,025.00
--------	--------------------------	------------

Form F • 2cm

690319	Pos. 1.....Ogee.....	\$299.00
690228	Pos. 2.....Ogee.....	299.00

Form F • 2.5cm

690313	Pos. 1.....Ogee.....	\$459.00
117966	Pos. 2.....Ogee.....	459.00
690524	Pos. 3.....Ogee.....	459.00
690460	Pos. 4.....Ogee.....	459.00
690461	Pos. 5.....Ogee.....	459.00

Form F • 3cm

690509	Pos. 1.....Ogee.....	\$513.00
690305	Pos. 2.....Ogee.....	513.00
620012	Pos. 3.....Ogee.....	513.00
621650	Pos. 4.....Ogee.....	513.00
621651	Pos. 5.....Ogee.....	513.00

Form H • 1.5cm

690295	Pos. 1.....Dupont.....	\$436.00
690285	Pos. 2.....Dupont.....	436.00

Form H • 2cm

690585	Pos. 1.....Dupont.....	\$369.00
690586	Pos. 2.....Dupont.....	369.00
910005	Pos. 3.....Dupont.....	369.00
910006	Pos. 4.....Dupont.....	369.00
910007	Pos. 5.....Dupont.....	369.00

Form O • 2.5cm

618228	Pos. 1.....Cove Dupont.....	\$486.00
618229	Pos. 2.....Cove Dupont.....	486.00
690563	Pos. 3.....Cove Dupont.....	486.00
690557	Pos. 4.....Cove Dupont.....	486.00
690558	Pos. 5.....Cove Dupont.....	486.00

Form Q • 2.5cm

690361	Pos. 1.....Cove Ogee.....	\$513.00
690362	Pos. 2.....Cove Ogee.....	513.00
698992	Pos. 3.....Cove Ogee.....	513.00
698993	Pos. 4.....Cove Ogee.....	513.00
698994	Pos. 5.....Cove Ogee.....	513.00

Router Bit Bearings- Closed Profiles

690368	2CM or 4CM, Bearing for Closed Profiles.....	\$49.95
690369	3CM, Bearing for Closed Profiles.....	44.95

Router Bit Bearings- Open Profiles

690419	30MM, Bearing for Open Profiles.....	\$32.45
--------	--------------------------------------	---------

Replacement Bolts

118037	4 Bolts, M10 Sleeve, M10 Thread 30mm L.....	\$23.95
118039	4 Bolts, M10 Sleeve, M8 Thread 40mm L.....	19.95

Produce custom edges with
Legend router bits!

Provide a dimensioned sketch of the profile including measurements. Your custom profile can be produced within 5 business days in most cases.



Recon® Router Bits

Recon router bits combine high performance and economical pricing for an excellent value. Fast and clean cutting.

Form A • 2cm R=10

697601	Pos. 1.....Round over...	\$226.95
106918	Pos. 2.....Round over.....	226.95

Form B • 2cm R=20

697602	Pos. 1.....Demi bull.....	\$205.95
--------	---------------------------	----------

Form B • 3cm R=30

697617	Pos. 1.....Demi bull.....	\$309.00
697618	Pos. 2.....Demi bull.....	309.00

Form E • 2cm

697604	Pos. 1.....Bevel.....	\$226.95
697605	Pos. 2.....Bevel.....	226.95

Form E • 3cm

698900	Pos. 1.....Bevel.....	\$379.00
698901	Pos. 2.....Bevel.....	379.00

Form F • 2cm

697612	Pos. 1.....Ogee.....	\$205.95
106923	Pos. 1-SEGMENTED..Ogee.....	245.95
697613	Pos. 2.....Ogee.....	205.95

Form F • 3cm

697621	Pos. 1.....Ogee.....	\$275.00
106920	Pos. 1-SEGMENTED..Ogee.....	309.00
697622	Pos. 2.....Ogee.....	275.00

Recon Router Bit Bearing-Open Profiles

697669	Bearing for Open Profiles.....	\$26.75
--------	--------------------------------	---------

Recon Router Bit Bearing-Closed Profiles

697668	Bearing for Closed Profiles.....	\$26.75
--------	----------------------------------	---------

Form V+B • 4cm

697627	Pos. 1.....Bullogee.....	\$560.00
--------	--------------------------	----------

Form H • 2cm

697610	Pos. 1.....Dupont.....	\$205.95
--------	------------------------	----------

Form H • 2.5cm

697614	Pos. 1.....Dupont.....	\$219.95
--------	------------------------	----------

Form O • 2.5cm

697616	Pos. 1.....Cove Dupont..	\$265.95
698923	Pos. 2.....Cove Dupont....	265.95

Form S+M • 4cm

697629	Pos. 1.....Pencil.....	\$422.00
697630	Pos. 2.....Pencil.....	422.00

Form V • 2cm

697606	Pos. 1.....Full Bullnose..	\$319.00
697607	Pos. 2.....Full Bulnose.....	319.00

Form V • 3cm

697619	Pos. 1.....Full Bullnose..	\$350.00
106919	Pos. 1-SEGMENTED..Full Bullnose....	397.95
697620	Pos. 2.....Full Bullnose....	350.00

Form V • 4cm

697625	Pos. 1.....Full Bullnose..	\$370.00
697626	Pos. 2.....Full Bullnose....	370.00

Form V • 6cm

697657	Pos. 1.....Full Bullnose..	\$577.00
--------	----------------------------	----------

Diasant® Premium Blue Diamond Router Bits

NEW!

Diasant Premium Blue Router Bits have been improved to be even faster than before with High Speed diamond formulations. Premium Blue wheels are produced in virtually any profile or shape needed, including custom drawn profiles. With patented toucher bearing technology Diasant Premium Blue router bits provide perfect and consistent profiles every time. Diasant wheels can be transformed into different profiles by just replacing the toucher.

- Fast, clean cutting and long life
- Available in many shapes and sizes
- Consistent forms



Stock No.	Description	Price
442718	A 20 HS, POS 1	\$319.99
442720	A 20 HS, POS 2	319.99



Stock No.	Description	Price
442726	A 30 HS, POS 1	\$373.40
442728	A 30 HS, POS 2	373.40



Stock No.	Description	Price
442732	B 20 HS, POS 1	\$377.44



Stock No.	Description	Price
442797	F 20 HS, SEGMENTED ..	\$329.87
442799	F 20 HS, POS 1	336.60
442801	F 20 HS, POS 2	336.60



Stock No.	Description	Price
442805	F 30 HS, SEGMENTED ..	\$393.60
442807	F 30 HS, POS 1	512.00
442809	F 30 HS, POS 2	464.00



Stock No.	Description	Price
442822	P+F 30, SEGMENTED...	\$344.23
442824	P+F 30, POS 1	533.17
442827	P+F 30, POS 2	465.45



Stock No.	Description	Price
442812	OG 30, SEGMENTED	\$572.22
442814	OG 30 HS, POS 1	620.00



Stock No.	Description	Price
442860	Ø 30, SEGMENTED	\$363.53
442857	Ø 30 HS, POS 1	469.00
442859	Ø 30 HS, POS 2	469.00



Stock No.	Description	Price
442869	Q 30 HS, POS 1	\$466.75



Stock No.	Description	Price
442874	T 30 HS, POS 1	\$497.45
442875	T 30 HS, POS 21	552.02



Stock No.	Description	Price
442739	B 30, SEGMENTED	\$392.25
442741	B 30 HS, POS 1	495.92



Stock No.	Description	Price
442787	E 20 HS, POS 1	\$388.21
442789	E 20 HS, POS 2	388.21



Stock No.	Description	Price
442791	E 30 HS, SEGMENTED...	\$402.12
442792	E 30 HS, POS 1	459.93



Stock No.	Description	Price
442297	CRESCENT HS, POS 1 ...	\$422.84
442299	CRESCETN HS, POS 2	422.85



Marmo® Segmented Z-Wheel

Marmo's segmented Z-wheels work well on granite, marble and engineered stones with excellent grinding power. Wheels include toucher.

- Provides a stable grinding platform
- Prevents gouging and uneven grinds
- One piece molded body for even wear

Stock No.	Description	Price
442920	Marmo Z-Wheel.....	\$489.28



Removable bearing
Fixed bearing

Pulsar® Segmented Z-Wheel

Pulsar's segmented Z-wheels are for use with most stone routers on granite, marble and engineered stones. Great for producing drop in sinks and intricate radius work.

- Use for grinding out sink holes
- Great on granite & engineered stone
- One piece molded body for even wear

Stock No.	Description	Price
442915	Pulsar 3CM Wheel..... w/Removable Bearing	\$275.00
442916	Pulsar 3CM Wheel..... w/Fixed Position Bearing	275.00
442918	Pulsar 4CM Wheel..... w/Removable Bearing	299.00



Electroplated Shaping Bits

- 30/40 grit
- 5/8" – 11 female thread
- Bearing guide included

Stock No.	Description	Guide	Price
912972	45° Bevel 1/2" Thick	Bottom....	\$309.00
910972	60° Bevel 1/4" Thick	Bottom.....	299.00
910916	2" Dia. x 2" Thick Drum ...	Top	339.00
910920	3" Dia. x 2" Thick Drum ...	Top	463.00



Electroplated Router Bits

- 30/40 grit
- Bolt and bearing guide included

Stock No.	Description	Shape	Thickness	Price
100147	Eased Edge .. 3/16" R ...	A ...	-	\$201.95
100148	Eased Edge 1/4" R ...	A ...	-	215.95
100149	Eased Edge 3/8" R ...	A ...	-	257.00
100158	Full Bullnose.. 3 cm	V ...	3 cm.....	515.00
100169	Ogee.....	2 cm	F....2 cm.....	309.00
100164	45° Bevel	1/4" ...	E	171.95
100166	45° Bevel	1/2" ...	E	215.95
100173	2" Ø x 2" Drum	Z.....	5cmmax ..	335.00



1/2" Shafted Electroplated Router Bits

- 30/40 grit • 6-10k RPMs

Stock No.	Size	Description	Price
934601	1/2" Dia. x 1 1/2" L	Blunt End	\$79.56
934602	1/2" Dia. x 1 1/2" L	Sphere End	76.56
910603	1/2" Dia. x 1 1/2" L	Blunt End w/slot	86.56



Oma Systems Antarex Bowl Cutting Bit

- Used with OMA Antarex system
- 44,000 Rpm
- Use with plastic template or freehand

Stock No.	Description	Price
052560	Oma Antarex 3-4 CM.....	\$79.95

ALPHA

Alpha® Profiling Bits

Designed to cut profiles on granite and engineered stone surfaces. Vacuum brazed with internal waterfeed.

- 5/8"-11 Arbor
- Max. RPM: 3,500
- Wet cutting
- Nylon guide

Stock Number	Description	Price
914000	B: 3/8".....	\$141.26
913999	B: 3/16".....	141.26
913998	B: 3/4".....	176.76
913997	V: 3cm.....	255.00
913987	V 4cm.....	270.00
913995	RE-10 profiler, 45° bevel.....	191.69
913994	Z 3cm.....	220.00



Shaft Adapters for Ghines-Style Router Bits

Modifies Ghines-style bits for use with any router that accepts 1/2" straight shaft.

- Accepts Ghines-style guide bearings
- Not recommended for 4cm (1 1/2") bits except Ghines form Z



Stock No.	Description	Price
903600	1/2" Shaft to Ghines Male.....	\$39.45
910046	1/2" Gas Male to Ghines Male.....	43.65

GranQuartz
Pro Series



(950271)

(950270)

Pro Series® Edge Breakers

- Formulated for fast cutting action and long life
- Save wear and tear on valuable shaping bits

Stock Number	Description	Price
950270.....	Single edge breaker.....	\$133.95
950271.....	Double edge breaker.....	257.00



Alpha® Half-Bullnose Wheels

Designed to profile and cut 3/8" marble tile in one pass, saving you time and money. For wet use on most popular tub and tile saws, ideal for both shop and site work.

Stock No.	Diam.	Arbor	Price
117741	6"	5/8"	\$281.14



Pro Series® Vacuum Brazed Profiling Wheel

Pro Series vacuum brazed profilers are designed for use with angle grinders.

- Use wet or dry
- Cuts fast, long lasting
- 5/8"-11 connection

Stock Number	Description	Price
696398	1/4" Roundover.....	\$169.95
696399	3/8" Roundover.....	177.95
696400	2cm Ogee.....	259.95

T-31 ANCHORING SYSTEM ACCESSORIES



T-31 Electroplated Anchor Bits

Electric & Pneumatic
T-31 Anchor Machines
on Page 236

Available with 3/8" or 1/4" shank.

Stock No.	Description	Price
933306	3/16" with 3/8" Shank	\$26.19
933299	1/4" with 3/8" Shank	34.13
933302	3/8" with 3/8" Shank	49.95
933018	3/16" with 1/4" Shank	31.28
933307	1/4" with 1/4" Shank	39.78
364294	3/8" with 1/4" Shank	62.86



Anchor Bit Adapters

Choose standard or premium anchor bit adapter. Standard adapter uses two screws to hold a 3/8" shaft tool in place. Premium adapter uses a collet system that centers the bit exactly for precise cutting, and holds either 1/4" or 3/8" shafts. Premium adapter includes 2 collets 1/4" and 3/8" and wrench.

Stock No.	Description	Price
924987	Premium Collet Adapter.....	\$275.00
924988	Replacement Premium Collet Adapter 5-6mm.....	61.90
924989	Replacement Premium Collet Adapter 3/8"	61.90
925072	Replacement Premium Collet Adapter 6.5mm.....	61.90
924981	Replacement Wrench for Premium adapter	59.80
924158	Standard Collet Adapter.....	30.99



Alpha® Vacuum Brazed Trimmer Bits



Versatile tool perfect for trimming electrical receptacles, water-valve holes, shower knobs, etc. Designed for use on Granite, Engineered stone, Porcelain Tile and other materials.

- Wet or Dry Use
- 1/4" Diameter
- 1/4" Shank
- Max RPM 33,000

Stock Number	Size	Price
116352	2" x 1/4"	\$48.72



Pro Series® Vacuum Brazed Anchor Bits

- Fast cutting action
- Available with either 3/8" or 1/4" shank.
- Vacuum brazed for long life

Stock No.	Size/Shank	Price
933301	3/16" with 3/8" shank	\$21.95
933303	1/4" with 3/8" shank	27.25
933305	3/8" with 3/8" shank.....	30.40
Stock No.	Size/Shank	Price
933309	3/16" with 1/4" shank	\$26.20
933310	1/4" with 1/4" shank.....	29.35



Intended for
Mounting Sinks Only.

T Anchors (with Nuts, Washers & Lock Washers)

Sold in packs of 25, stainless steel.

Stock Number	Description	Price/Pkg.
933313	3/16" x 1 1/2"	\$20.51
933314	3/16" x 2"	22.33
933315	3/16" x 2 1/2"	23.59
933316	1/4" x 1 1/4"	22.33
933317	1/4" x 1 1/2"	23.59
933318	1/4" x 1 3/4"	23.59
933319	1/4" x 2"	25.07
933320	1/4" x 2 1/2"	31.45

Stock Number	Description	Price/Pkg.
933321	1/4" x 3"	\$34.14
933322	1/4" x 4"	45.54
933323	3/8" x 2"	46.68
933324	3/8" x 2 1/2"	45.89
933325	3/8" x 3"	61.50
933326	3/8" x 4"	70.11



Strap Anchors

Stock Number	Description	Price
940401	#1..... 1/8" x 1" One Way	\$4.45
940402	#2..... Sink Clip Adapter.....	2.19
940107	#7..... 1/8" x 1" Two Way	6.99
940122	B..... 1/16" x 1" Two Way.....	4.98

Sinks and Sink
Installation Supplies
on Pages 162-167

PROFILING BITS & SHAPING TOOLS

Diarex® Profiling Bits

Recommended for use with König Pneumatic Pencil Grinder, ideal for sculpting and detailing.

- Sintered diamond design for superior performance
- Wet or dry use
- 6mm connection shaft

GranQuartz
DIAREX®



Stock No.	Bit No./Style	Description	Price
115822	#16 Milling Wheel	37mm x 12mm	\$186.50
103355	#18 Blade	25mm	120.00
103356	#21 Profile Bit	16mm x 8.7mm	117.00
103359	#23 Profile Bit	8mm x 16mm	208.00
103361	#24 Profile Bit	8mm x 16mm	236.00
115811	#25 Profile Bit	12.5mmx15mm	64.95

Stock No.	Bit No./Style	Description	Price
115813	#26 Profile Bit	10mm x 30mm	\$237.00
115815	#27 Profile Bit	12mmx20mm	161.25
103366	#28 Profile Bit	13mm dia.	152.95
115817	#29 Profile Bit	25mm x 6mm	178.95
115823	#30 Dry Cut Turbo	50mm	85.95

DW® Electroplated Profiling Bits

For detail work on marble and granite.

- Use wet
- 6mm connection shaft (1/4" shaft also available)
- Other sizes and shapes available by special order

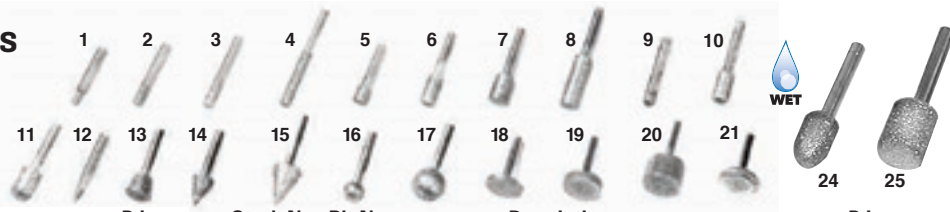

Stock No.	Bit No.	Description	Price
914001	1	5/32" dia. blunt x 3/8" long	\$21.91
914002	2	1/4" dia. blunt x 1/2" long	24.71
914003	3	1/4" dia. blunt x 3/4" long	27.10
914004	4	1/4" dia. blunt x 1 1/2" long	30.51
914005	5	3/8" dia. blunt x 3/8" long	22.65
914006	6	3/8" dia. blunt x 3/4" long	28.47
914007	7	1/2" dia. blunt x 3/4" long	28.71
914008	8	1/2" dia. blunt x 1 1/2" long	31.52
914009	9	1/4" sphere end x 3/8" long	24.25
914010	10	3/8" sphere end x 3/4" long	32.01
914011	11	1/2" sphere end x 3/4" long	34.84
914012	12	pointed	18.05

Stock No.	Bit No.	Description	Price
914013	13	dove tail 5/8" diameter	\$37.97
914014	14	cone 1/2" diameter x 3/4" long	36.33
914015	15	cone 3/4" diameter x 1 1/8" long	38.83
914016	16	1/2" diameter ball	26.86
914017	17	3/4" diameter ball	40.60
914018	18	1" diameter x 1/8" disc	44.26
914019	19	1" diameter x 1/4" disc	34.16
914020	20	1" diameter x 3/4" disc	48.16
914021	21	1" diameter x 1/8" radius edge disc	33.94
914524	24	bullet 1/2" diameter x 3/4" long	44.26
914525	25	5/8" dia. blunt x 3/4" long	33.47



Diamond Burr Set, 8 pc.

Electroplated burr set for detail work on marble and soft stone using handheld tools.

- Use wet or dry



Stock No.	Description	Price
695979	1/8" Shank, 50 Grit	\$15.07



Stock No.	Description	Price
695980	6 pc. Set - 1/4" Shank, 80 Grit	\$19.40



Stock No.	Description	Price
695981	5 pc. Set - 1/4" Shank, 50 Grit	\$19.40



Dongsin® Jigsaw Blades

Dual segment, 110mm length blades for curved or straight cutting of granite, marble and engineered stone surfaces using a Jigsaw.

- Use for Wet Cutting Only
- For Granite, Marble & Engineered Stone

Stock No.	Description	Price
122982	110mm, Galeski Connection	\$79.95
123355	110mm, Quick Universal Connection	79.95



Dongsin® Shaping Bits

High quality sculpting tools for handheld use.

- Wet or Dry Use
- For Granite, Marble & Engineered Stone



Stock No.	Description	Price	Stock No.	Description	Price
122990	NR.16 6.3MM Shank Gear	\$99.57	122985	NR.26 6.3MM Shank Cylinder	\$67.23
122989	NR.17 6.3MM Shank Saw	85.97	122988	NR.26 XL 6.3MM Shank Cylinder	80.46
122986	NR.18 6.3MM Shank Coin	69.07	122987	NR.27 6.3MM Shank Cone	69.07
122983	NR.21 6.3MM Shank Funnel	59.15	122984	NR.29 6.3MM Shank Ring	64.30

Square and Rectangular Suction Cups



120 x 120mm Square
Stock No. 360859



150 x 150mm Square
Stock No. 360858



50 x 300mm Rectangle
Stock No. 360868



75 x 300mm Rectangle
Stock No. 360914



150 x 240mm Rectangle
Stock No. 360943



150 x 300mm Rectangle
Stock No. 360877



200 x 200mm Square
Stock No. 360841



200 x 400mm Rectangle
Stock No. 360890



Vanity Cups
Stock No. 361017



75 x 500mm Rectangle
Stock No. 361006



250 x 500mm Rectangle
Stock No. 360875



50 x 500mm Rectangle
Stock No. 361005



100 x 500mm Rectangle
Stock No. 361013



150 x 500mm Rectangle
Stock No. 360874

Top Replacement Seals

Stock No.	Description
366827	Suction Cup, 50 X 300 mm Top Seal
367960	Suction Cup, 50 X 500 mm Top Seal
366895	Suction Cup, 70 X 150 mm Top Seal
366803	Suction Cup, 70 X 240 mm Top Seal
366796	Suction Cup, 75 X 300 mm Top Seal
366843	Suction Cup, 75 X 200 mm Top Seal
368003	Suction Cup, 75 X 500 mm Top Seal
367923	Suction Cup, 90 mm Round Top Seal
366877	Suction Cup, 100 X 100 mm Top Seal
367615	Suction Cup, 120 mm Round Top Seal
366879	Suction Cup, 120mm Round Stone Top Seal
366805	Suction Cup, 120 X 120 mm Top Seal
366882	Suction Cup, 120 mm RC Top Seal
366840	Suction Cup, 120 X 150 mm Top Seal
366885	Suction Cup, 150 mm Round Top Seal
366804	Suction Cup, 150 X 150 mm Top Seal
367616	Suction Cup, 150 mm RC Top Seal

Stock No.	Description
366795	Suction Cup, 150 X 240 mm Top Seal
366850	Suction Cup, 150 mm CC Top Seal
366825	Suction Cup, 150 X 240 mm CC Left Top Seal
366826	Suction Cup, 150 X 240 mm CC Rt Top Seal
366815	Suction Cup, 150 X 300 mm Top Seal
3666837	Suction Cup, 150 X 500 mm Top Seal
367606	Suction Cup, 160 mm Round Top Seal
366874	Suction Cup, 200 mm Round Top Seal
366792	Suction Cup, 200 X 200 mm Top Seal
366794	Suction Cup, 200 X 300 mm Top Seal
366841	Suction Cup, 200 X 400 mm Top Seal
366793	Suction Cup, 200 mm RC Top Seal
366816	Suction Cup, 250 mm Round Top Seal
382623	Suction Cup, 250 X 250 mm Top Seal
366817	Suction Cup, 250 X 500 mm Top Seal
367892	Suction Cup, Sink Cup Left Top Seal
366922	Suction Cup, Vanity Sink Cup Top Seal

Bottom Replacement Seals

Stock No.	Description
361034	1 Clamp, Large Mech Clamp Bottom Seal
366797	Suction Cup, 200 X 200 mm Bottom Seal
366798	Suction Cup, 200 X 300 mm Bottom Seal
366802	Suction Cup, 200 mm RC Bottom Seal
366819	Suction Cup, 250 X 500 mm Bottom Seal
366820	Suction Cup, 150 X 500 mm Bottom Seal
366821	Suction Cup, 200 X 400 mm Bottom Seal
366847	Suction Cup, 250 mm Round Bottom Seal
366872	Fence, 150 X 300 mm Bottom Seal
366873	Suction Cup, 200 mm Round Bottom Seal
366890	Suction Cup, 160 mm Round Bottom Seal
367608	Suction Cup, 200 mm Round Retract Cup Bottom Seal
367617	Suction Cup, 250 X 250 mm Bottom Seal
367631	Fence, 150 X 250 mm Bottom Seal

Round Suction Cups



150mm Round
Stock No. 360941



350mm Round
Stock No. 360939

Radius & Shaped Suction Cups



120mm Radius
Stock No. 360948



200mm Radius
Stock No. 360946



150mm Concave
Stock No. 360840



150mm x 240 Concave
Stock No. 360881 [Left]



150mm x 240 Concave
Stock No. 360882 [Right]



Vacuum Pods

- Anodized Aluminum
- Vulcanized Rubber on Top and Bottom Plates
- Double Sealed, Replaceable Rubber Gaskets
- Modular Design for Low Shipping Cost



ADI® CNC Vacuum System

ADI Vacuum Pods are precision manufactured in Italy to the exacting OEM specifications of the industry's top stone machinery manufacturers. ADI vacuum pods' modular design option allows easy replacement of damaged com-

ponents, as well as the ability to assemble custom pod solutions. ADI Vacuum Pods are available in a wide range of shapes and sizes. Call GranQuartz for more details. 1-800-458-6222.



Modular design option for lower shipping costs and no need to ship entire pods across the country for rework due to damage or wear.

Vulcanized rubber plates with double sealed rubber gaskets that are easily replaceable (and more wear resistant than foam gaskets found on other systems).



200mm x 200 Square
x 105 Height
Stock No. 911729



500mm x 250 Rectangle
x 105 Height
Stock No. 911837



45mm x 300 - 300 x 150
x 105 Height
Stock No. 911963



100mm x 100 Square
x 105 Height
Stock No. 911705



150mm Corner x 105 Height
Stock No. 911969

What makes our TOTAL CNC PROGRAM BETTER?

ADI® Tooling + ZOLLER pre-setting equipment, ADVANT-Edge dressing machine and AD-Vise tool removal press, a TOTAL SOLUTION for building a completely modular CNC work flow.

ADI provides the best performance and value for high volume production. ADI's UHS (Ultra High Speed) tooling is consistently proven the best choice for high volume production shops. An investment in UHS tooling pays dividends in the form of the lowest cost per linear meter and a superior final quality of the work.

ADI tooling is manufactured in Italy using the absolute highest level of quality control in the diamond tool industry.

- Available in 120 series, 80 series, 40 series & 20 series
- Customized pre-set labels on each wheel
- Precision balanced
- Full water channel design
- More water distribution points
- Lowest cost per linear foot in the industry
- ADI certified reshaping service available



120 series UHS tooling



40 series ADI Eraser tooling



ZOLLER Pre-Setter and Tool Management for CNC profile tooling

- Maximizes your CNC program by allowing offline tool calibration
- More precise setup creates increased tool life



Advant-Edge Tool Dressing Machine

- Onsite, offline tool re-dressing saves time and money



Ad-Vise CNC Tool Press

- Remove "seized" tooling from connection cones without damage to the diamond cutting surface

Knowledgeable, Experienced CNC Service Technicians

You can depend on our certified CNC technicians to train your operators onsite on your machine. Our technicians have over 60 years combined in the CNC tooling and fabrication industry. Call for more information on how we can help you optimize your CNC tooling and equipment program.



Carlo Artina



Michael Rosener



Josh Serres

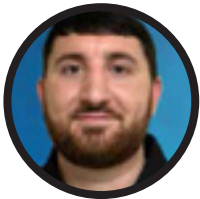

Caleb Thompson



Alston Tidwell

Stone industry's largest inventory of CNC tooling

GranQuartz fills your CNC orders quickly and accurately with tooling shipped daily from 14 stocking locations!



Hands-Free Profile Wheels

ADI® has taken a selection of popular profiles and slightly modified the design to enhance shop productivity. The result is a line of profiles that can go directly from the machine to the transport rack, without the need for touching-up the shape or easing sharp edges. ADI Hands-Free profiles save time & money, and allow users to fully take advantage of their equipment investment.



MFP5 Profile Wheels

ADI's Special Hybrid technology drastically reduces visible polish lines and extends the life of a polishing series. Replace the first polishing position in either the UHS or Veloce series for the ultimate polish. The MFP5 is available in many different shapes and sizes and is especially effective on profiles prone to polishing lines such as A, T, ZR and others.



ADI Magic Profile Wheels

Magic profile wheels are the latest innovation in resin bonded cnc polishing wheels, perfect for operators utilizing compensation programs. In addition to longer tool life and high quality polishing, ADI's Magic wheels are perfectly suited for fabricating granite and most engineered stone surfaces, unlike other brands of comparatively designed resin bonded wheels.



ADI EXPRESS Solid Rubber Profile Wheels

Express rubber wheels are long-lasting and produce the best polish of any rubber wheels available. Express wheels are designed with a continuous outer layer of diamond abrasive that flexes around the tool's core and grips the work piece with a snug fit and the correct amount of pressure to eliminate signs of "orange peel". Express wheels deliver a very high level of gloss. For use with UHS or Veloce tooling.

ADI®- World's Finest CNC Tooling

ADI is known as the most innovative and widely specified manufacturer of CNC tooling for the stone industry. ADI has a long history as the premier developer of diamond tooling including:

- UHS (Ultra High Speed) technology
- Widest range of available sizes and profiles, with highest level of consistency and accuracy
- Highest quality diamond tooling
- Fastest and most consistent tool re-dressing program with six EDM's located in the U.S. for quick turn around time

Every ADI metal tool includes a custom pre-set sticker for that particular tool, and gives you the precise information to load into your CNC. The pre-set sticker is an extra step ADI takes to assist the end user, and is another reason why ADI is the leading CNC tool manufacturer in the stone industry.



Balanced tools - better finishing results, better spindle life

- Preset information by Zoller - Faster more accurate setup
- All profiles available with UHS technology - faster working parameters
- Closed profiles available with radius or chamfer better finishing - lowers need for hand fabrication
- MFP5 (finer diamond grit size available for shallower lines) lessens need for hand polishing
- Longer life - lower cost per linear foot

Water Flow: EDM Produced Water Openings

- Many similar sized wheels do not have the same amount of water slots, some tooling is produced with none at all
- The water slots are cut into the tooling with an EDM machine, a time-intensive process
- Many manufacturers cut costs by putting fewer slots, which adversely impacts the quality of the finished product
- Hole placement and diameter of the opening matters
- Other tooling may have less water holes causing decreased life as the tool heats up and distorts during production, reducing useful life and causing lines in the stone

Why This Matters

- *More water = more debris removal, ability to run faster feed speeds, better finish and less tool wear*

Depth of diamonds in the wheel

- The thickness of the sintered segments impacts the tool's performance, life, finish quality and time required to calibrate the tool
- Many tooling manufacturers only put diamonds in the outer layers of their tooling to save cost and lessen manufacturing time
- Shallower diamond depth will allow tools to damage faster and limits the ability to re-dress and EDM the tooling

Limited investments in these areas = Less expensive tooling, that doesn't run as long, is more easily damaged, causing undesired fabrication results (additional labor costs).

- EDM technology for a perfect shape of the wheel and interchangeability
- US facility with 6 CNC EDM machines - fast turnaround of tooling - minimizes downtime & need for redressing
- Technical service provided by different technicians directly at end user facility (4 Techs in US)

ADI - USA's CNC Re-dressing facility is unique to the stone industry, and adds value to your tooling investment

- ADI factory trained and certified technicians
- Complete technical analysis of used or damaged diamond tooling
- Faster turnaround times on re-dressing ALL your ADI CNC tooling
- Returns tools to their original factory specifications
- Maximizes the life of your CNC tools



ADI-USA's North Carolina Re-dressing Facility

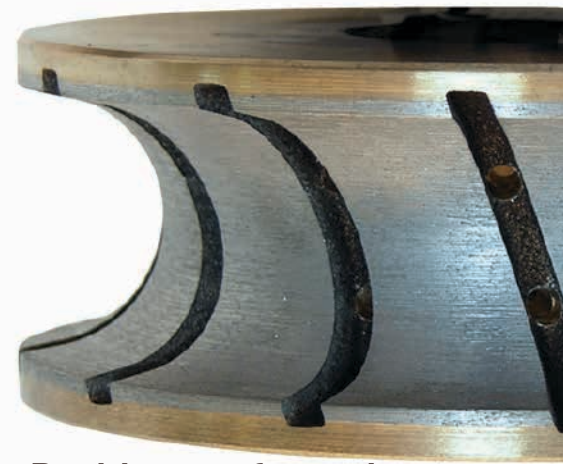

Precision manufactured water slots

Intricately engineered water slots are precisely machined into each tool, an extra step most manufacturers don't perform.

120 SERIES PROFILING WHEELS

**Form A • 3cm**

POS.1	Segmented	929152
POS.2	Cont. Rim	929153
POS.3	Cont. Rim	929154
POS.4	Cont. Rim	929155
POS.5	Magic	953600
POS.6	Magic	953601
POS.5	Express Rubber	953201
POS.6	Express Rubber	953202
POS.7	Express Rubber	953203
POS.5	MFP5	942805

Form BB30-1 • 3cm

POS.1	Segmented	929658
POS.2	Cont. Rim	929659
POS.3	Cont. Rim	929660
POS.4	Cont. Rim	929661
POS.5	Magic	953610
POS.6	Magic	953611
POS.5	Express Rubber	953237
POS.6	Express Rubber	953238
POS.7	Express Rubber	953239
POS.5	MFP5	942815

Form FV • 3cm

POS.1	Segmented	929176
POS.2	Cont. Rim	929177
POS.3	Cont. Rim	929178
POS.4	Cont. Rim	929179
POS.5	Magic	953632
POS.6	Magic	953633
POS.5	Express Rubber	953270
POS.6	Express Rubber	953271
POS.7	Express Rubber	953272
POS.5	MFP5	942853

Form T • 4cm R=8mm

POS.1	Segmented	929357
POS.2	Cont. Rim	929358
POS.3	Cont. Rim	929359
POS.4	Cont. Rim	929360
POS.5	Magic	953729
POS.6	Magic	953730
POS.5	Express Rubber	953363
POS.6	Express Rubber	953364
POS.7	Express Rubber	953365
POS.5	MFP5	942841

A30-1 • 3cm

POS.1	Segmented	929152
POS.2	Cont. Rim	929595
POS.3	Cont. Rim	929596
POS.4	Cont. Rim	929597
POS.5	Magic	953602
POS.6	Magic	953603
POS.5	Express Rubber	953204
POS.6	Express Rubber	953205
POS.7	Express Rubber	953206
POS.5	MFP5	942806

Form F • 3cm

POS.1	Segmented	929180
POS.2	Cont. Rim	929181
POS.3	Cont. Rim	929182
POS.4	Cont. Rim	929183
POS.5	Magic	953612
POS.6	Magic	953613
POS.5	Express Rubber	953252
POS.6	Express Rubber	953253
POS.7	Express Rubber	953254
POS.5	MFP5	942819

Form FV • 4cm

POS.1	Segmented	929229
POS.2	Cont. Rim	929230
POS.3	Cont. Rim	929231
POS.4	Cont. Rim	929232
POS.5	Magic	953709
POS.6	Magic	953710
POS.5	Express Rubber	953273
POS.6	Express Rubber	953274
POS.7	Express Rubber	953275
POS.5	MFP5	942854

Form V • 3cm

POS.1	Metal	929128
POS.2	Cont. Rim	929129
POS.3	Cont. Rim	929130
POS.4	Cont. Rim	929131
POS.5	Magic	953620
POS.6	Magic	953621
POS.5	Express Rubber	953372
POS.6	Express Rubber	953373
POS.7	Express Rubber	953374
POS.5	MFP5	942802

Form B • 3cm

POS.1	Segmented	929132
POS.2	Cont. Rim	929133
POS.3	Cont. Rim	929134
POS.4	Cont. Rim	929135
POS.5	Magic	953604
POS.6	Magic	953605
POS.5	Express Rubber	953488
POS.6	Express Rubber	953489
POS.7	Express Rubber	953490
POS.5	MFP5	942809

Form F30-3 • 3cm

POS.1	Segmented	942184
POS.2	Cont. Rim	929278
POS.3	Cont. Rim	929279
POS.4	Cont. Rim	929280
POS.5	Magic	953614
POS.6	Magic	953615
POS.5	Express Rubber	953255
POS.6	Express Rubber	953256
POS.7	Express Rubber	953257
POS.5	MFP5	942820

Form FZ • 3cm

POS.1	Segmented	929136
POS.2	Cont. Rim	929137
POS.3	Cont. Rim	929138
POS.4	Cont. Rim	929139
POS.5	Magic	953628
POS.6	Magic	953629
POS.5	Express Rubber	
POS.6	Express Rubber	
POS.7	Express Rubber	
POS.5	MFP5	

Form V • 4cm

POS.1	Segmented	929156
POS.2	Cont. Rim	929157
POS.3	Cont. Rim	929158
POS.4	Cont. Rim	929159
POS.5	Magic	953636
POS.6	Magic	953637
POS.5	Express Rubber	953375
POS.6	Express Rubber	953376
POS.7	Express Rubber	953377
POS.5	MFP5	942844

Form B30-1 • 3cm

POS.1	Segmented	929132
POS.2	Cont. Rim	929622
POS.3	Cont. Rim	929623
POS.4	Cont. Rim	929624
POS.5	Magic	953606
POS.6	Magic	953607
POS.5	Express Rubber	953225
POS.6	Express Rubber	953226
POS.7	Express Rubber	953227
POS.5	MFP5	942810

Form FS • 3cm

POS.1	Segmented	925935
POS.2	Cont. Rim	929190
POS.3	Cont. Rim	929191
POS.4	Cont. Rim	929192
POS.5	Magic	953707
POS.6	Magic	953706
POS.5	Express Rubber	953264
POS.6	Express Rubber	953265
POS.7	Express Rubber	953266
POS.5	MFP5	942823

Form FZ30-9 • 3cm

POS.1	Segmented	929136
POS.2	Cont. Rim	929599
POS.3	Cont. Rim	929600
POS.4	Cont. Rim	929601
POS.5	Magic	953642
POS.6	Magic	953643
POS.5	Express Rubber	953279
POS.6	Express Rubber	953280
POS.7	Express Rubber	953281
POS.5	MFP5	942873

Form VB • 3cm

POS.1	Segmented	929265
POS.2	Cont. Rim	929266
POS.3	Cont. Rim	929267
POS.4	Cont. Rim	929268
POS.5	Magic	953685
POS.6	Magic	953686
POS.5	Express Rubber	953381
POS.6	Express Rubber	953382
POS.7	Express Rubber	953383
POS.5	MFP5	942846

Form BB • 3cm

POS.1	Segmented	929185
POS.2	Cont. Rim	929186
POS.3	Cont. Rim	929187
POS.4	Cont. Rim	929188
POS.5	Magic	953608
POS.6	Magic	953609
POS.5	Express Rubber	953234
POS.6	Express Rubber	953235
POS.7	Express Rubber	953236
POS.5	MFP5	942813

Form FS 30-1 • 3cm

POS.1	Segmented	929172
POS.2	Cont. Rim	929173
POS.3	Cont. Rim	929174
POS.4	Cont. Rim	929175
POS.5	Magic	953651
POS.6	Magic	953652
POS.5	Express Rubber	953267
POS.6	Express Rubber	953268
POS.7	Express Rubber	953269
POS.5	MFP5	942801

Form T • 3cm R=10mm

POS.1	Segmented	929164
POS.2	Cont. Rim	929165
POS.3	Cont. Rim	929166
POS.4	Cont. Rim	929167
POS.5	Magic	953647
POS.6	Magic	953648
POS.5	Express Rubber	953360
POS.6	Express Rubber	953361
POS.7	Express Rubber	953362
POS.5	MFP5	942840

Form VB • 4cm

POS.1	Segmented	929221
POS.2	Cont. Rim	929222
POS.3	Cont. Rim	929223
POS.4	Cont. Rim	929224
POS.5	Magic	953744
POS.6	Magic	953845
POS.5	Express Rubber	953384
POS.6	Express Rubber	953385
POS.7	Express Rubber	953386
POS.5	MFP5	942847

Many Additional Shapes & Sizes Available

80 SERIES PROFILING WHEELS



Form A • 3cm R=15mm A

POS.1	Segmented	929225
POS.2	Cont. Rim	929226
POS.3	Cont. Rim	929227
POS.4	Cont. Rim	929228
POS.5	Magic	953600
POS.6	Magic	953601
POS.5	Express Rubber	953201
POS.6	Express Rubber	953202
POS.7	Express Rubber	953203
POS.5	MFP5	942802

Form Z • 2cm Z

POS.1	Segmented	929425
POS.2	Cont. Rim	929426
POS.3	Cont. Rim	929427
POS.4	Cont. Rim	929428
POS.5	Magic	953860
POS.6	Magic	953861
POS.5	Express Rubber	953387
POS.6	Express Rubber	953388
POS.7	Express Rubber	953389
POS.5	MFP5	942861

Form ZR • 3cm R=10mm ZR

POS.1	Segmented	929213
POS.2	Cont. Rim	929214
POS.3	Cont. Rim	929215
POS.4	Cont. Rim	929216
POS.5	Magic	953640
POS.6	Magic	953641
POS.5	Express Rubber	953402
POS.6	Express Rubber	953403
POS.7	Express Rubber	953404
POS.5	MFP5	942865

Form A30-1 • 3cm

POS.1	Segmented	929225
POS.2	Cont. Rim	929691
POS.3	Cont. Rim	929692
POS.4	Cont. Rim	929693
POS.5	Magic	953602
POS.6	Magic	953603
POS.5	Express Rubber	953204
POS.6	Express Rubber	953205
POS.7	Express Rubber	953206
POS.5	MFP5	942806

Form Z • 3cm Z

POS.1	Super Z	929611
POS.2	Cont. Rim	929125
POS.3	Cont. Rim	929126
POS.4	Cont. Rim	929127
POS.5	Magic	953622
POS.6	Magic	953623
POS.5	Express Rubber	953390
POS.6	Express Rubber	953391
POS.7	Express Rubber	953392
POS.5	MFP5	942862

Form ZR • 4cm R=5mm ZR

POS.1	Segmented	929409
POS.2	Cont. Rim	929410
POS.3	Cont. Rim	929411
POS.4	Cont. Rim	929412
POS.5	Magic	953748
POS.6	Magic	953749
POS.5	Express Rubber	953408
POS.6	Express Rubber	953409
POS.7	Express Rubber	953410
POS.5	MFP5	942867

Form AR • 3cm AR

POS.1	Segmented	929313
POS.2	Cont. Rim	929314
POS.3	Cont. Rim	929315
POS.4	Cont. Rim	929316
POS.5	Magic	953683
POS.6	Magic	953684
POS.5	Express Rubber	953213
POS.6	Express Rubber	953214
POS.7	Express Rubber	953215
POS.5	MFP5	942849

Form Z • 4cm Z

POS.1	Segmented	929209
POS.2	Cont. Rim	929210
POS.3	Cont. Rim	929211
POS.4	Cont. Rim	929212
POS.5	Magic	953638
POS.6	Magic	953639
POS.5	Express Rubber	953426
POS.6	Express Rubber	953394
POS.7	Express Rubber	953395
POS.5	MFP5	942863

Form ZS • 3cm ZS

POS.1	Segmented	929193
POS.2	Cont. Rim	929194
POS.3	Cont. Rim	929195
POS.4	Cont. Rim	929196
POS.5	Magic	953679
POS.6	Magic	953680
POS.5	Express Rubber	953417
POS.6	Express Rubber	953418
POS.7	Express Rubber	953419
POS.5	MFP5	942869

Form SM • 3cm SM

POS.1	Segmented	929249
POS.2	Cont. Rim	929250
POS.3	Cont. Rim	929251
POS.4	Cont. Rim	929252
POS.5	Magic	953731
POS.6	Magic	953732
POS.5	Express Rubber	953339
POS.6	Express Rubber	953340
POS.7	Express Rubber	953341
POS.5	MFP5	942857

Form ZS30-1 • 3cm

POS.1	Segmented	929193
POS.2	Cont. Rim	929554
POS.3	Cont. Rim	929555
POS.4	Cont. Rim	929556
POS.5	Magic	953752
POS.6	Magic	953753
POS.5	Express Rubber	953420
POS.6	Express Rubber	953421
POS.7	Express Rubber	953422
POS.5	MFP5	942870

Form ZS • 4cm ZS

POS.1	Segmented	929261
POS.2	Cont. Rim	929262
POS.3	Cont. Rim	929263
POS.4	Cont. Rim	929264
POS.5	Magic	953681
POS.6	Magic	953682
POS.5	Express Rubber	953433
POS.6	Express Rubber	953427
POS.7	Express Rubber	953428
POS.5	MFP5	942871

Many Additional Shapes & Sizes Available!

Form ZR • 3cm R=5mm ZR

POS.1	Segmented	929120
POS.2	Cont. Rim	929121
POS.3	Cont. Rim	929122
POS.4	Cont. Rim	929123
POS.5	Magic	953624
POS.6	Magic	953625
POS.5	Express Rubber	953399
POS.6	Express Rubber	953400
POS.7	Express Rubber	953401
POS.5	MFP5	942800



Dust and Silica Warning See Inside Front Cover



California residents see Prop 65 warnings www.P65Warnings.ca.gov

40 SERIES PROFILING WHEELS

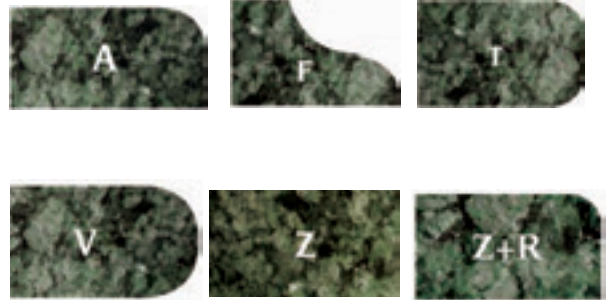
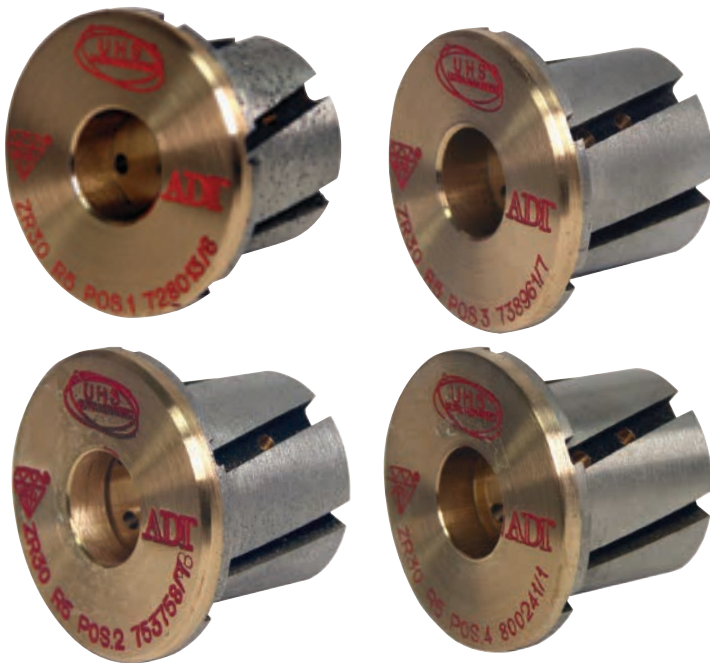
**A20 • 2cm R=10mm**

		A
POS.1	Segmented	927306
POS.2	Cont. Rim	927307
POS.3	Cont. Rim	927308
POS.4	Cont. Rim	927309
POS.5	Magic	927310
POS.6	Magic	927311
POS.5	Express Rubber	927312
POS.6	Express Rubber	927313
POS.7	Express Rubber	927314
POS.5	MFP5	927315

T30 • 3cm R=6mm

		T
POS.1	Segmented	927372
POS.2	Cont. Rim	927373
POS.3	Cont. Rim	927374
POS.4	Cont. Rim	927375
POS.5	Magic	953727
POS.6	Magic	953728
POS.5	Express Rubber	927378
POS.6	Express Rubber	927379
POS.7	Express Rubber	927380
POS.5	MFP5	927381

Z40 • 4cm

		Z
POS.1	Segmented	927422
POS.2	Cont. Rim	927423
POS.3	Cont. Rim	927424
POS.4	Cont. Rim	927425
POS.5	Magic	927426
POS.6	Magic	927427
POS.5	Express Rubber	927428
POS.6	Express Rubber	927429
POS.7	Express Rubber	927430
POS.5	MFP5	927431

A30 • 3cm R=15mm

		A
POS.1	Segmented	926290
POS.2	Cont. Rim	926291
POS.3	Cont. Rim	926292
POS.4	Cont. Rim	926293
POS.5	Magic	927320
POS.6	Magic	927321
POS.5	Express Rubber	927322
POS.6	Express Rubber	927323
POS.7	Express Rubber	927324
POS.5	MFP5	927325

V30 • 3cm R=15mm

		V
POS.1	Segmented	927392
POS.2	Cont. Rim	927393
POS.3	Cont. Rim	927394
POS.4	Cont. Rim	927395
POS.5	Magic	927396
POS.6	Magic	927397
POS.5	Express Rubber	927398
POS.6	Express Rubber	927399
POS.7	Express Rubber	927400
POS.5	MFP5	927401

ZR20 • 2cm R=5mm

		ZR
POS.1	Segmented	927432
POS.2	Cont. Rim	927433
POS.3	Cont. Rim	927434
POS.4	Cont. Rim	927435
POS.5	Magic	927436
POS.6	Magic	927437
POS.5	Express Rubber	927438
POS.6	Express Rubber	927439
POS.7	Express Rubber	927440
POS.5	MFP5	927441

T20-1 • 2cm R=3.5mm

		T
POS.1	Segmented	927352
POS.2	Cont. Rim	927353
POS.3	Cont. Rim	927354
POS.4	Cont. Rim	927355
POS.5	Magic	N/A
POS.6	Magic	N/A
POS.5	Express Rubber	953547
POS.6	Express Rubber	953548
POS.7	Express Rubber	953549
POS.5	MFP5	N/A

Z30 • 3cm

		Z
POS.1	Segmented	927412
POS.2	Cont. Rim	927413
POS.3	Cont. Rim	927414
POS.4	Cont. Rim	927415
POS.5	Magic	953675
POS.6	Magic	953676
POS.5	Express Rubber	927418
POS.6	Express Rubber	927419
POS.7	Express Rubber	927420
POS.5	MFP5	927421

ZR30 • 3cm R=5mm

		ZR
POS.1	Segmented	929900
POS.2	Cont. Rim	929901
POS.3	Cont. Rim	929902
POS.4	Cont. Rim	929903
POS.5	Magic	953735
POS.6	Magic	953738
POS.5	Express Rubber	953538
POS.6	Express Rubber	953539
POS.7	Express Rubber	953540
POS.5	MFP5	927442

Many Additional Shapes & Sizes Available

20 SERIES MICRO-LINE PROFILE TOOLING



Perfect for profiling sink cutouts and other small radius curves!

- 20mm Diameter
- 1/2" Gas Connection
- Patented design



ADI's 20mm Micro-Line tooling features single continuous rim design with 2 EDM slots. The continuous design now has a higher concentration of diamond and is extremely rigid. Field tests have produced almost double the life of comparable tooling.

- Improved Life and Finish
- More Rigid/Robust design
- Higher Concentration of diamond
- Continuous design holds profile shape longer
- Less vibration with continuous design

Save valuable time by profiling & polishing hard to reach places with your CNC.

Available in these profiles

**AR20 • 2cm • 20mm diameter • 1/2" Gas**

Description	Stock Number
Pos. 1/Segmented, Metal	929537
Pos. 2/Segmented, Metal	929538
Pos. 3/Segmented, Metal	929539
Pos. 4/Segmented, Metal	935152
Pos. 5/Express	953472
Pos. 6/Express	953473
Pos. 7/Express	953474
ERASER	942874

AR30 • 3cm • 20mm diameter • 1/2" Gas

Description	Stock Number
Pos. 1/Segmented, Metal	929541
Pos. 2/Segmented, Metal	929542
Pos. 3/Segmented, Metal	929543
Pos. 4/Segmented, Metal	935153
Pos. 5/Express	953515
Pos. 6/Express	953516
Pos. 7/Express	953517
ERASER	942874

T20 • 2cm • 20mm diameter • 1/2" Gas

Description	Stock Number
Pos. 1/Segmented, Metal	929381
Pos. 2/Segmented, Metal	929382
Pos. 3/Segmented, Metal	929383
Pos. 4/Segmented, Metal	929384
Pos. 5/Express	953574
Pos. 6/Express	953575
Pos. 7/Express	953576
ERASER	942874

T30 • 3cm • 20mm diameter • 1/2" Gas

Description	Stock Number
Pos. 1/Segmented, Metal	929385
Pos. 2/Segmented, Metal	929386
Pos. 3/Segmented, Metal	929387
Pos. 4/Segmented, Metal	929388
Pos. 5/Express	953577
Pos. 6/Express	953578
Pos. 7/Express	953579
ERASER	942874

Z20 • 2cm • 20mm diameter • 1/2" Gas

Description	Stock Number
Position 1/Segmented, Metal	929393
Position 2/Segmented, Metal	929394
Position 3/Segmented, Metal	929395
Pos. 5/Express	N/A
Pos. 6/Express	N/A
Pos. 7/Express	N/A
ERASER	N/A

Z30 • 3cm • 20mm diameter • 1/2" Gas

Description	Stock Number
Position 1/Segmented, Metal	929305
Position 2/Segmented, Metal	929306
Position 3/Segmented, Metal	929307
Position 4/Segmented, Metal	929308
Pos. 5/Express	953556
Pos. 6/Express	953557
Pos. 7/Express	953558
ERASER	942874

ZR20 • 2cm • 20mm diameter • 1/2" Gas

Description	Stock Number
Position 1/Metal	929533
Position 2/Metal	929534
Position 3/Metal	929535
Position 4/Metal	929536
Pos. 5/Express	953565
Pos. 6/Express	953566
Pos. 7/Express	953567
ERASER	942874

ZR30 • 3cm • 20mm diameter • 1/2" Gas

Description	Stock Number
Position 1/Metal	929309
Position 2/Metal	929310
Position 3/Metal	929311
Position 4/Metal	929312
Pos. 5/Express	953491
Pos. 6/Express	953486
Pos. 7/Express	953487
ERASER	942875



Dust and Silica Warning See Inside Front Cover



California residents see Prop 65 warnings
www.P65Warnings.ca.gov

MFP5 PROFILING WHEELS

Special Hybrid technology drastically reduces visible polish lines and extends the life of a polishing series. Replace the first polishing position in either the UHS or Veloce series for the ultimate polish.

The MFP5 is available in many different shapes and sizes and is especially effective on profiles prone to polishing lines such as A, T, ZR, etc..

[Note: Some shapes are SPECIAL ORDER]



ADI^{USA}
EQUITAL INDUSTRIES, INC.

Profile	Description	Stock No.
Form A	2cm	942804
Form A	3cm	942805
Form A1	3cm	942806
Form AR	2cm	942848
Form AR	4cm	942850
Form B	2cm	942808
Form B	3cm	942809
Form B	4cm	942811
Form BB	2cm	942812
Form BB	3cm	942813
Form BB	4cm	942814
Form D	3cm	942817
Form F	2cm	942818
Form F3	3cm	942820
Form FS	2cm	942822
Form FV	3cm	942853
Form FV	4cm	942854
Form FZ	3cm	942824
Form H	3cm	942827
Form I	3cm	942831
Form L	3cm	942833

Profile	Description	Stock No.
Form M	3cm	942834
Form O	3cm	942836
Form OZ	3cm	942855
Form QB	3cm	942838
Form SM	2cm	942856
Form SM	3cm	942857
Form SM	4cm	942858
Form T	3cm R=3	942803
Form T	3cm R=6	942123
Form T4	3cm	942860
Form V	2cm	942843
Form V	3cm	942802
Form VB	4cm	942847
Form VB	3cm	942846
Form Z	2cm	942861
Form Z	3cm	942862
Form Z	4cm	942863
Form ZR	2cm R=5	942864
Form ZR	3cm R=5	942800
Form ZR	4cm R=5	942867
Form ZS	3cm	942869
Form ZS	4cm	942871

ADI^{USA}
EQUITAL INDUSTRIES, INC.



ADI® SUPER-Z UHS® Profile Wheels

For rapidly trimming the peripheral edge of a work piece. Use the Super Z in the place of a finger bit for outside edge trimming applications. With UHS® technology, the Super Z provides superior processing speed and long life.

Stock No.	Description	Arbor
929611	78 x 35mm	35mm
929625	78 x 45mm	35mm

ADI^{USA}
EQUITAL INDUSTRIES, INC.



ADI® Pre-Cut UHS Breaker Bits

Extend the life of your valuable profile wheels by using an ADI edge breaker. With UHS technology, the ADI edge breaker series rapidly removes material and does so with long life.

- Available in Single/130mm or Double/120mm

Stock No.	Description	Arbor
929281	SINGLE, 130mm	35mm
929282	DOUBLE, 120mm	35mm

ADI^{USA}
EQUITAL INDUSTRIES, INC.



ADI® Mitre Ninja Pre-Cut Bit

Miter Ninja is an exciting addition to the Ninja series of stackable pre-cut tools. The Miter Ninja can be used alone or stacked together with any combination of Ninja Blades. Stack two Miter Ninjas together as a double breaker; by adding or removing #1 blades in the middle of the two Miter Ninjas, you can use the tool set on 2cm, 3cm, or 4cm material.

- 15mm Height
- 35mm Connection
- Use single Ninja bit [for Y Profiles] or double stacked Ninja bits [for X Profiles]

Stock No.	Description
929832	Mitre Ninja Bit
929780	#1 Ninja Blade, 70mm Diameter

NINJA PRE-CUT TOOLING



Ninja pre-cut blades can be stacked in literally thousands of different configurations giving users the flexibility to accommodate most any profile or any specific need.

- Fast, free cutting
- 5mm thick with integrated water channels
- Vary from 70mm to 155mm in diameter
- Flexible and economical



Stock No.	Description
929779	Blade spacer/35mm ID x 48mm OD x 5mm
929780	Precut blade #1/70mm Dia. x35mm bore
929781	Precut blade #2/80mm Dia. x35mm bore
929782	Precut blade #3/90mm Dia. x35mm bore
929783	Precut blade #4/100mm Dia. x35mm bore
929784	Precut blade #5/110mm Dia. x35mm bore
929785	Precut blade #6/120mm Dia. x35mm bore
929786	Precut blade #7/130mm Dia. x35mm bore
929787	Precut blade #8/140mm Dia. x35mm bore
929819	Precut Blade #1.5/75mm Dia. x35mm bore

Stock No.	Description
929820	Precut Blade #2.5/85mm Dia. x35mm bore
929821	Precut Blade #3.5/95mm Dia. x35mm bore
929822	Precut Blade #4.5/105mm Dia. x35mm bore
929823	Precut Blade #5.5/115mm Dia. x35mm bore
929824	Precut Blade #6.5/125mm Dia. x35mm bore
929825	Precut Blade #7.5/135mm Dia. x35mm bore
929826	Precut Blade #8.5/145mm Dia. x35mm bore
929860	Precut Blade #9/150mm Dia. x35mm bore
929827	Precut Blade #9.5/155mm Dia. x35mm bore

CNC FINGERBITS



ADI® Goldfinger Segmented CNC Fingerbit
for Engineered Stone and Granite



A break-in period is required on Goldfinger fingerbits. Run the new bit at 60% of its maximum feed rate & 80% of its max RPM for the first 200mm of material processed.

Stock No.	Description	Price
925565	22 x 35mm ..	\$128.95

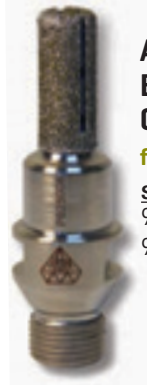

ADI® Electroplated CNC Fingerbit
for Marble



Stock No.	Description	Price
925594	16 x 45mm ..	\$169.95
925592	16 x 35mm ..	130.00



ADI® Segmented CNC Fingerbit For UCS

for cutting Ultra Compact Surfaces [UCS]



Six segment bit designed with an all new bond for fast, clean cutting of very hard materials. The ADI UCS finger bit mills through ultra compact surfaces cleanly with long life.

• 1/2" Gas connection

Stock No.	Description	Price
913128	19 x 38mm.....	\$129.95



ADI® Hydro Segmented CNC Fingerbit
for Engineered Stone and Granite



- 1/2" Gas connection
- Wet cutting only

Stock No.	Description	Price
927626	22 x 35mm ..	\$147.24



ADI® Solution Segmented CNC Fingerbit
for Engineered Stone and Granite



- 1/2" Gas connection
- Wet cutting only

Stock No.	Description	Price
927622	22 x 35mm ..	\$123.07



ADI® Magnificat Segmented CNC Fingerbit
for Engineered Stone and Granite

- 1/2" Gas connection
- Wet cutting only

Stock No.	Description	Price
927624	22 x 35mm ..	\$120.87





ADI® Falcon CNC Fingerbit

Designed to provide durability and fast, smooth cutting on granite, engineered stone and a variety of hard surfaces using 6 low profile segments and nearly twice the number of water holes as competitors' finger bits.

- Wet use only
- 1/2" Gas connection
- Lowest cost per linear foot

Stock No.	Description	Price
939000	22 x 35mm	\$133.95
939001	22 x 48mm	169.95



ADI® UHS Segmented CNC Fingerbit

For use on medium hard stone.

- Wet use only, Ultra High Speed
- Achieves rates of 500-600mm/min

Stock No.	Description	Price
925563	22 x 35mm	\$128.95
925566	24 x 48mm	153.99



Bronze Segmented CNC Fingerbit

For use on medium hard stone.

- Wet use only
- 1/2" Gas connection

Stock No.	Description	Price
925596	22 x 35mm	\$128.95



Blue Segmented CNC Fingerbit

For use on medium hard stone.

- Wet use only
- 1/2" Gas connection

Stock No.	Description	Price
925584	22 x 35mm	\$128.95
925586	24 x 48mm	153.45
925585	26 x 60mm	251.95
925528	22 x 48mm*	165.00



*With Bottom Segment



Red Segmented CNC Fingerbit

For use on hard stone.

- Wet use only
- 1/2" Gas connection

Stock No.	Description	Price
925588	22 x 35mm	\$128.95
925590	24 x 48mm	153.45
925591	26 x 65mm	275.00
925587	22 x 35mm*	190.00



*With Bottom Segment



Black Segmented CNC Fingerbit

For use on porcelain and glass.

- Wet use only
- 1/2" Gas connection

Stock No.	Description	Price
925597	22 x 35mm	\$188.95



Silver Segmented CNC Fingerbit

For use on abrasive stone.

- Wet use only
- 1/2" Gas connection

Stock No.	Description	Price
925580	22 x 35mm	\$128.95
925582	24 x 48mm	153.45



GranQuartz® Blue Thunder CNC Fingerbit

Formulated for high speed cutting on all types of granite and engineered stone surfaces. Reinforced segment design for better rigidity.

- Wet use only
- 1/2" Gas connection
- 6 Segments

Stock No.	Description	Price
935175	20 x 40mm, 6 Segments.....	\$109.95



Pulsar® 8-Segment High Speed CNC Fingerbit

Pulsar's high speed 8 segment fingerbit runs at speeds up to 25" per minute! Excellent results on hard & soft granite and engineered stone. Max. 7,000 rpm.

- Wet use only
- 1/2" Gas connection

Stock No.	Description	Price
445517	3/4" D x 1 1/2" L.....	\$285.00



Diamond Wright® Electroplated CNC Fingerbit

DW finger bits have 1/2 gas connection with center water feed and can be replated when exhausted.

- Wet use only
- 1/2" Gas connection
- Electroplated diamond

Stock No.	Description	Price
924008	1" D x 4" L.....	\$285.00





**Zenesis®
CNC Fingerbit**



For use on Granite and engineered stone.

- Wet use only
- 1/2" Gas connection
- RPM: 4,200 (hard material) to 5,500 (softer material) with a feed rate of 12"-16" per minute

Stock No.	Description	Price
360724	20 x 40mm, 4 Segments	\$92.50
360725	22 x 50mm, 4 Segments	103.00
360726	20 x 40mm, 7 Segments	92.50
360727	22 x 50mm, 7 Segments	103.00



**Super Cyclone®
Seven Segment Fingerbit**

For high speed cutting on granite and engineered stone surfaces. Reinforced segment design for better rigidity. Great for ultra hard materials.

- Wet use only
- 1/2" Gas connection
- 7 Segments
- Feed rate: 10" - 20"/min.
- Speed: 4500 - 6000 RPM

Stock No.	Description	Price
359518	22 x 40mm, 7 Segments	\$119.95



**Weha®
Top Racer
8-Segment
CNC Fingerbit**

Weha's high speed 8 segment fingerbit runs at speeds up to 36" per minute on hard & soft granite and engineered stone.

- Wet use only
- 1/2" Gas connection
- Max speed: 8,500 RPM

Stock No.	Description	Price
445510	3/4" D x 1 1/2" L	\$135.00



**Dongsin®
Absolute Fingerbit**

Formulated for high speed cutting on all types of granite and engineered stone surfaces. Reinforced segment design for better rigidity.

- 1/2" Gas Connection
- 5 Segments

Stock No.	Description	Price
116785	20 x 40mm, 5 Segments	\$136.95
116786	22 x 50mm, 5 Segments	145.95



**Cayenna
CNC Fingerbit**

For use on Granite and engineered stone.

- Wet use only
- 1/2" Gas connection
- 4 Segments

Stock No.	Description	Price
360694	20 x 40mm, 4 Segments	\$93.00

Medium bond
5,500-6,000 RPM @ 14-20 IPM



**Orange Krush
CNC Fingerbit**

For use on Marble, Granite and engineered stone.

- Wet use only
- 1/2" Gas connection
- 5 Segments

Stock No.	Description	Price
359522	23 x 40mm, 5 Segments	\$94.45
359530	25 x 70mm, 5 Segments	178.45

Soft bond
5,500-6,000 RPM @ 15-20 IPM



**Orange Krush Hybrid
CNC Fingerbit**

For use on Marble, Granite and engineered stone.

- Wet use only
- 1/2" Gas connection
- 6 Segments

Stock No.	Description	Price
359529	20 x 40mm, 6 Segments	\$104.95

Soft bond
5,500-6,000 RPM @ 15-20 IPM



**Yellow Jacket
CNC Fingerbit**

For use on Hard stone surfaces.

- Wet use only
- 1/2" Gas connection
- 6 Segments

Stock No.	Description	Price
359527	23 x 40mm, 6 Segments	\$83.95
359528	23 x 50mm, 6 Segments	94.95

Softest bond for hard stone
5,500 RPM @ 10-12 IPM in HARD Stone
6,500 RPM @ 15-20 IPM in SOFT/MED. Stone



**Rival Twin Turbo
CNC Fingerbit**

For use on Hard stone surfaces.

- Wet use only
- 1/2" Gas connection
- 8 Segments

Stock No.	Description	Price
360738	20 x 40mm, 8 Segments	\$79.95

Soft bond
5,500-6,000 RPM @ 12-20 IPM



**Dongsin® Twin Segment
CNC Fingerbit**

For use on Hard stone surfaces.

- Wet use only
- 1/2" Gas connection
- 8 Segments

Stock No.	Description	Price
116782	20 x 40mm	\$126.00
116783	20 x 45mm	132.00
116784	23 x 50mm	140.00



UHS Heavy Duty Stubbing Wheel

Stock No.	Description	Arbor	Price
926127	54 x 25 x 7mm.....	10mm	\$218.95
925558	91 x 30 x 7mm.....	50mm	345.00
925933	150 x 25 x 7mm.....	50mm	456.00

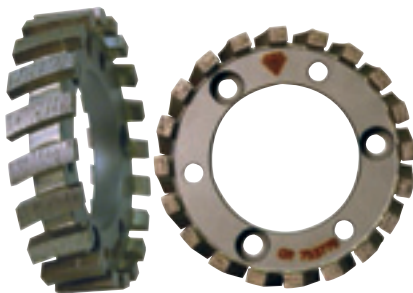

Stubbing Wheel

Stock No.	Description	Arbor	Price
925653	87 x 20 x 5mm Position 1	50mm	\$279.00



Red Stubbing Wheel

Stock No.	Description	Arbor	Price
925541	91 x 30 x 7mm	50mm	\$345.00

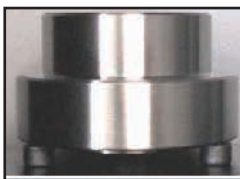

Stubbing Wheel 35mm Bore CNC Cones

Stock No.	Price
925539	\$110.00



Stubbing Wheel 1/2" Gas Connection

Stock No.	Price
926050	\$91.00



XPert Super Z 3cm Profile Wheel

For high speed stock removal, cutting notches for back splash, scribe to a digital template. Faster than a traditional fingerbit.

Stock No.	Price
359523	\$346.45

Pro Series® CNC Cones

Pro Series cones are made of 4150 pre-hardened alloy steel, heat-treated with permanently infused surface hardness to Vickers 1880 (75+ Rockwell C) with diffusion zone (approx. RC 60) and an RC 28-32 core hardness.

Surface hardness withstands the 72 hour salt spray corrosion test under ASTM B117 conditions, reducing surface flaking and galling. Pro Series cones are taper ground to a maximum of .0001 concentricity for long wearing spindle fit, superior accuracy and no vibration.

Bavelloni		
925832 ISO 40 - 35mm x 39mm	\$206.95
925840 Old Style ISO 40 - 22mm x 39mm	247.95
925833 ISO 40 - 1/2 Gas.....	175.00
925853 ISO 40 - 35mm x 87mm	348.00
Brembana		
925821 Old Style ISO 40 - 35mm x 39mm.....	206.95
912179 Old Style ISO 40 - 35mm x 80mm.....	348.50
925825 Old Style ISO 40 - 1/2 Gas x 40mm	190.00
925830 New Style ISO 40 - 35mm x 39mm	206.95
925831 New Style ISO 40 - 1/2 Gas.....	190.00
925919 New Style ISO 40 - 35mm x 80mm	348.50
Breton		
925836 HKS-B80 - 35mm x 39mm.....	265.95
925837 HKS-B80 - 1/2 Gas	238.95

Intermac		
925835 ISO 40 - 1/2 Gas.....	190.00
925799 ISO 40 - 35mm x 39mm	206.95
925976 ISO 40 - 35mm x 47mm	247.50
Northwood		
925798 Gen. II ISO 40 35mm x 39mm.....	206.95
925765 Gen. II ISO 40 - 1/2 Gas	190.00
925786 Gen. III ISO 40 - 35mm x 39mm.....	206.95
925788 Gen. III ISO 40 - 35mm x 47mm.....	247.50
925789 Gen. III ISO 40 - 1/2 Gas.....	190.00
Park		
925823 Gen. I ISO 40 - 35mm x 39mm.....	206.95
925824 Gen. I ISO 40 - 1/2 Gas	190.00
926028 Gen. II ISO 40 - 1/2 Gas	190.00
926027 Gen. II ISO 40 - 35mm x 39mm.....	206.95
925199 Gen. II ISO 40 - 35mm x 80mm.....	348.50



Features/ Specifications	Diarex Pro Series	400 Stainless Heated Treated	8260 Alloy Electroless Nickel
Surface Hardness	75 + RC	50-55 RC	60-65 RC
Surface Flaking	NO	NO	YES
Surface Galling	NO	YES	YES

IMS Stainless Steel CNC Cones

IMS® Stainless Steel connection cones are for use with CNC machines including Brembana, Breton, Intermac, Northwood, and Park Industries. Stainless steel, Italian made. (other sizes available upon request).



New Brembana

92112435mm x 39mm.....	ISO 40.....	\$227.45
9211261/2 Gas.....	ISO 40.....	227.45
92112435mm x 39mm.....	ISO 40.....	227.45
92112535mm x 47mm.....	ISO 40.....	227.45
92112035mm x 80mm.....	ISO 40.....	240.00
9211261/2 Gas.....	ISO 40.....	227.45

Brembana Classic [Old Style Brembana]

92112735mm x 39mm.....	ISO 40.....	\$256.35
9211281/2 Gas.....	ISO 40.....	256.35

Intermac

92113335mm x 39mm.....	ISO 40.....	\$227.45
92113435mm x 47mm.....	ISO 40.....	227.45
92854435mm x 80mm.....	ISO 40.....	227.45
92113022mm x 39mm.....	ISO 40.....	227.45
9211351/2 Gas.....	ISO 40.....	227.45
92115522mm x 39mm.....	ISO 40.....	227.45
92115622mm x 47mm.....	ISO 40.....	227.45
9211601/2 Gas.....	ISO 40.....	227.45

Northwood Gen. III

92116535mm x 39mm.....	ISO 40.....	\$227.45
9211671/2 Gas.....	ISO 40.....	227.45

Park Gen. I

92114435mm x 39mm.....	ISO 40.....	\$227.45
92114535mm x 47mm.....	ISO 40.....	227.45
92114322mm x 39mm.....	ISO 40.....	227.45
9211461/2 Gas.....	ISO 40.....	227.45

Park Gen. II

92116935mm x 39mm.....	ISO 40.....	\$227.45
92117035mm x 47mm.....	ISO 40.....	227.45
92811835mm x 80mm.....	ISO 40.....	227.45
92116822mm x 39mm.....	ISO 40.....	227.45
9211711/2 Gas.....	ISO 40.....	227.45

Breton

92114835mm x 39mm.....	HSK.....	\$352.25
9285431/2 Gas.....	HSK.....	352.25

Z Bavelloni

92854035mm x 47mm.....	ISO 40.....	\$227.45
92107235mm x 80mm.....	ISO 40.....	240.00
92854122mm x 39mm.....	ISO 40.....	227.45
9210641/2 Gas.....	ISO 40.....	227.45

RETENTION KNOB SELECTION REFERENCE BY MACHINE



Northwood
Gen. I
#925874



Northwood
Gen. II
#925872



Northwood
Gen. III
#925818



Park
Gen. I
#925810



Park
Gen. II
#926021

Lubricate Your Cone

Use TK Line White Grease to lubricate your CNC cones & CNC tooling. TK's Zinc oxide grease will prevent your profile tooling from seizing up on the cone, and will make tool removal much easier.



TK Line White Grease.....#928016



Stone Pro® Adjustable Polishing Adapter

- 1/2" of Travel to compensate tool wear and varying thickness without changing Z height
- Adjustable Pressure
- Polish Drain Board, Backsplashes, back of stone
- 1/2" Gas Thread with Snail Lock Adapter
- Center Water Feed
- Includes Wrench for Easy Tool Changes



Stock No.	Description	Price
500116	Adjustable Polishing Adapter.....	\$495.00
500117	Rigid Polishing Adapter.....	238.95



Ad-Vise CNC Tool Press

Removing tooling from CNC connection cones can be extremely difficult when the tooling becomes worn, rusted or bound to the cone from use. Damaging the bore or profile surface by aggressive tool removal can mean ruining the tool. It is very important to safely remove the tooling in a manner that enables EDM processing, increasing the useful life of the bit.



Stock No.	Description	Price
981771	Ad-Vise CNC Tool Press, Park Gen II.....	\$1,895.00
981773	Ad-Vise CNC Tool Press, Northwood Gen II.....	1,895.00
981772	Ad-Vise CNC Tool Press, Brembana.....	1,895.00
981774	Ad-Vise CNC Tool Press, Intermac.....	1,975.00
981775	Ad-Vise CNC Tool Press, Bavelloni.....	1,975.00



ADI® Black Thin Wall CNC Core Bits

- 1/2 Gas connection
- Ultra aggressive diamond matrix
- Wet use only



Stock No.	Length	Inside Diameter	Suggested RPM	Price
929015	3"	1 1/4" (32mm)	2,200-2,400	\$88.95
927097	3"	1 3/8" (35mm)	2,000-2,200	90.95
927098	3"	1 1/2" (38mm)	1,800-2,000	95.00
927077	3"	2" (50mm)	1,500-1,800	121.00



ADI® Thin Wall CNC Core Bits

- 1/2" Gas thread
- Wet use only



Stock No.	Length	Inside Diameter	Suggested RPM	Price
926856	3"	1" (25mm)	2,400-2,800	\$79.95
926857	3"	1 1/8" (30mm)	2,200-2,400	82.95
926850	3"	1 1/4" (32mm)	2,200-2,400	88.95
926852	3"	1 3/8" (35mm)	2,000-2,200	90.95
926854	3"	1 1/2" (38mm)	1,800-2,000	98.95



Pro Series® Thin Wall CNC Core Bits

- For granite
- 1/2" Gas Connection
- True Thin Wall Crown
- Wet use only
- Premium quality



Stock No.	Length	Diameter	RPM	Price
927546	4"	1 3/8"	2,000-2,800	\$81.50
927547	4"	1 1/2"	2,000-2,280	85.50
927549	4"	2"	2,000-2,280	99.00



ADI® Super Duty CNC Core Bits

ADI's new Super Duty Core Bits manufactured with a 2mm thick segmented crown. The thicker segment reduces the chance of the "mushroom effect". The bit has both 1/2 gas & 5/8-11 thread for use on CNC systems and hand held machines.

- For granite
- Length: 4" or 2 1/2"
- 1/2" Gas Connection
- Made in Italy
- Wet use only
- Premium quality



Stock No.	Length	Inside Diameter	Suggested RPM	Price
927907	4"	1 1/4"	2,400	\$95.00
927908	4"	1 3/8"	2,200	97.00
927909	4"	1 1/2"	2,200	99.00

CNC TOOL MEASURING AUTOMATION

ZOLLER SMILE Pilot CNC Tool Preset Measuring System

The newly designed Smile Pilot 3.0 tool presetter and measuring machine for CNC profile tools continues the success story of the ZOLLER Smile series. The new compact, robust, and ergonomic design makes it perfectly suited for use in a production environment. A special highlight is the user-friendly and state-of-the-art Pilot 3.0 image processing technology that comprises a variety of measuring programs.

Basic Equipment:

- Smile base table
- High precision SK 50 spindle with integrated calibration edge and spindle indexing
- Membrane keyboard for power-operated tool clamping, spindle brake, and spindle indexing
- Image processing with telecentric objective and CCD camera with integrated incident light multi LED lights
- 11th generation of measuring machine control
- Windows 7 64-bit Multilingual operating system
- 24" anti-glare multi-touch display with solid frameless glass surface
- Screen resolution 1920 x 1080 pixel
- 1 x USB 3.0 interface
- 6 x USB 2.0 interfaces
- 2 x RJ45 network connection
- 4 GB working memory
- Storage for at least 15,000 adapters and tool steps

Technical Data:

- Max. tool length Z: 400 mm/600 mm
- Max. tool diameter X: 420 mm
- Snap gauge diameter: 100 mm*

*Note: When selecting the "snap gauge" option, the maximum tool diameter in X is reduced to 320 mm.



Stock No.	Description	Price
981663	ZOLLER Smile 3.0 Presetter, Full CNC	\$51,956.00
981664	Lasso Software	5,724.64
981665	Data Output Software	2,608.70
981659	ZOLLER Smile Adapter, CAT 40/50.....	782.61
981660	ZOLLER Smile Adapter, HSK for Breton	2,152.17

Advant Edge Dressing Machine

Variable speed drive to allow user to control speed from 0-3,000 RPM.

- Precision Spindle that promotes precise rotation
- Fits any 40 taper tool holder
- Fits abrasive tooling up to 5" diameter
- Fits a 40 taper tool holder equipped with an RK1 or RK3 retention knob
- Gen II Park
- Gen III Northwood
- Intermac
- Brembana
- Baveloni

Not currently available for Breton HSK-80

- Additional 15amp GFCI outlet for plug-in options
- Dampening pads for minimal vibration and noise

Stock No.	Description	Price
981598	Advant Edge Machine.....	\$6,795.00
981600	HSK Adapter.....	977.50



Installation Requirements and Recommendations:
 Requires installation of a 110V 15 amp Twist Lock Receptacle
 Place in a dry and well lit area
 Port attached for Wet/Dry Vac on rear of tool housing

Dressing Sticks

Stock No.	Description	Price
361053	Black, 1 x 1 x 6"	\$6.95
361052	White, 1 x 1 x 6"	2.95



ADI® CNC Blades

For use with CNC machines including Brembana, Ravelli, Breton, Bavelloni and other popular machines.

Stock No.	Size	Arbor	Machine	Price
925909	150mm x 5 x 4	22mm.....	Intermec	\$180.00
926928	250mm x 10 x 2.8	50mm.....	Breton.....	205.95
926929	250mm x 10 x 2.8	50mm.....	Breton/engineered stone.....	205.00
926919	190mm x 7 x 5,30°	50mm.....	Brembana/concave,vac.brazed ...	459.00
925908	210mm x 10 x 2.8	50mm.....	Brembana	184.95



Pro Series® CNC Blade

Fast cutting blade with side segments for tighter radius cutting and core protection.

- 6" Diameter
- 25mm Arbor

Stock No.	Price
800226	\$226.95



White Dressing Stones

Dressing stones restore the performance of worn profile wheels, core bits and blades.

- Restore performance of worn tooling
- Proper use will prolong tool life

Stock No.	Description	Price
925306	For Profile Wheels Pos.1-3,200x60x30mm ..	\$7.23
925305	For Profile Wheels Pos.4,200x60x30mm	7.23
925313	For Profile Wheels Pos.1-4,200 x 60 x 30mm.....	6.85
925117	For Fingerbits, Blades, Core Bits	7.83
361052	1/4" x 1 1/2" x 6" White Stick.....	2.95



Black Dressing Stones

Can be used to redress position 1 CNC tools, finger bits, & core bits.

- 1" x 1" x 6" Black Dressing Stick
- 50 Grit

Stock No.	Description	Price
361053	Black Dressing Stick.....	\$6.95

C-FRAME MACHINE TOOLING

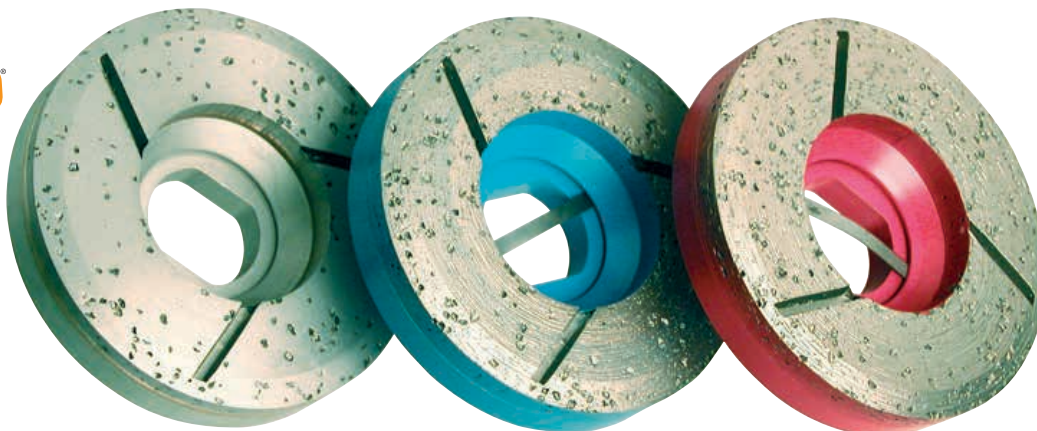

Pro Series® Diamond Shaping Wheels

For use on Park Pro-Edge, Denver Quasar and other C-Type Automated Edge Polishers

Stock Number	Description	Arbor	Price
700100	4" Pos. 00	Snail-Lock	\$205.95
700102	4" Pos. 1	Snail-Lock	205.95
700104	4" Pos. 2	Snail-Lock	205.95

NEW!



Diarex® ICE Flat Polishing Wheels

New resin formula and mold design reduces surface contact with the stone, with greater water flow for decreased chances of burning engineered stone.

- Available in 5" and 6" diameters, with snail lock connection
- Minimizes chance of burning edges on engineered stone in lighter or dark gray colors

5" (130mm) Diam.

Stock No.	Description	Price
113493	5", 50 Grit	\$69.95
113494	5", 100 Grit	69.95
113495	5", 200 Grit	69.95
113496	5", 400 Grit	69.95
113497	5", 800 Grit	69.95
113498	5", 1500 Grit	69.95
113499	5", 3000 Grit	69.95
113500	5", BUFF	69.95

6" (150mm) Diam.

Stock No.	Description	Price
113501	6", 50 Grit	\$90.95
113502	6", 100 Grit	90.95
113503	6", 200 Grit	90.95
113504	6", 400 Grit	90.95
113505	6", 800 Grit	90.95
113506	6", 1500 Grit	90.95
113507	6", 3000 Grit	90.95
113508	6", BUFF	90.95

GranQuartz
DIAREX®

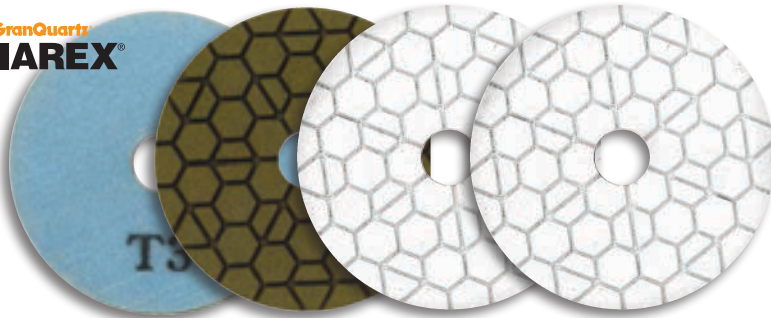

Diarex® Ice C-Frame 3 Step Polishing Pads

- 3-Step, can be used with pos. 1 & 2 metals
- Polish granite and engineered stone
- White resin on higher grits

Stock No.	Description	Price
115267	Step 3	\$29.95
115268	Step 4	29.95
115269	Step 5	29.95

GranQuartz
Pro Series

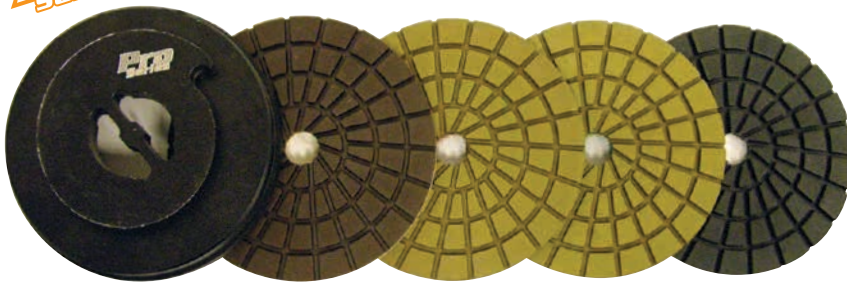

Pro Series® Five Step System

- Excellent for single head edge machines
- Polish most granites in 5 STEPS (position 6 optional)

Stock Number	Description	Color	Price
115728	Pos. 1	Metal	\$185.95
115729	Pos. 2	Metal	185.95
115730	Pos. 3	Resin	38.30
115731	Pos. 4	Resin	38.30
115732	Pos. 5	Resin	38.30
115838	Pos. 6	Resin Buff	38.30
115919	Thick Snail Lock Backer		10.29
115918	Thin Snail Lock Backer		9.29

NEW!



Alpha® GEM Flat Polishing Wheels

Alpha's new GEM line is a polishing system for all types of stone surfaces and is perfect for producing straight and beveled edges.

Gem polishing wheels are long lasting and provide fast, consistent results. Gem wheels are designed to fit most edge polishing machines and are recommended by Cosentino® as a Dekton® polishing system.

- Available in 5" and 6" diameters, with snail lock connection
- Tsuya final polishing step for the highest possible shine
- Available in 5" and 6" diameter
- Velcro® Backing (no wrenches needed for tool changes)

5" (130mm) Diam.

Stock No.	Description	Price
101260	5", 50 Grit	\$75.40
101261	5", 100 Grit	75.40
101262	5", 200 Grit	75.40
101263	5", 500 Grit	75.40
101264	5", 1000 Grit	75.40
101265	5", 2000 Grit	75.40
101266	5", 3000 Grit	75.40
101267	5", BUFF BLACK	75.40

6" (150mm) Diam.

Stock No.	Description	Price
101268	6", 50 Grit	\$98.47
101269	6", 100 Grit	98.47
101270	6", 200 Grit	98.47
101271	6", 500 Grit	98.47
101272	6", 1000 Grit	98.47
101273	6", 2000 Grit	98.47
101274	6", 3000 Grit	98.47
101275	6", BUFF BLACK	98.47



ADI® Eagle 5" Shaping Wheel



- Snail lock connection
- Aggressive stock removal
- Wet use only

Stock No.	Description	Price
700106	Position 1	\$200.00



Abrasive Technology® 4" Super Edge™ Five Step System

For polishing marble, granite and engineered stone surfaces using new generation, high-production C-frame machinery.

- Snail lock adapter for easy changes
- Shape full bullnose profiles & calibrate straight edges

Stock No.	Grit	Description	Price
693748	50.....	Black.....	\$244.95
693750	100.....	Blue.....	230.95
693749	150.....	Red.....	215.95
694408	Pos. 3.....	Polishing Pad.....	53.00
694409	Pos. 4.....	Polishing Pad.....	53.00
694410	Pos. 5.....	Polishing Pad.....	53.00

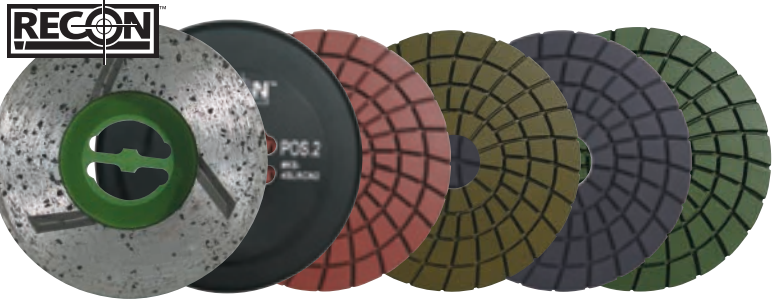

Recon™ Five Step System

- For aggressive stock removal and high quality polishing in one system
- Polishes most granites in 5 STEPS (position 6 optional for darker stones)

Stock Number	Grit	Description	Price
696063	Pos. 1	Green	\$185.95
696064	Pos. 2	Black	185.95
696257	Pos. 3	4" Polishing Pad	37.20
696258	Pos. 4	4" Polishing Pad	37.20
696259	Pos. 5	4" Polishing Pad	37.20
696260	Pos. 6	4" Polishing Pad	37.20

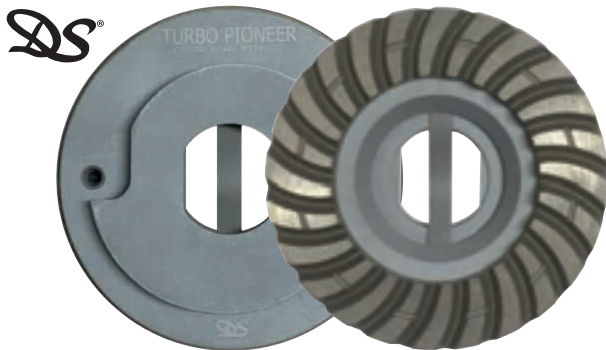

Dongsin® Pioneer 4" Turbo Flat Metal Polishing Wheels

- Snail lock connection
- Shape full bullnose profiles & calibrate straight edges
- Wet Use Only
- For Park Pro Edge (and similar systems)

Stock No.	Description	Price
123091	Coarse, Turbo Flat	\$199.95
123092	Medium, Turbo Flat.....	199.95
123093	Fine, Turbo Flat	199.95

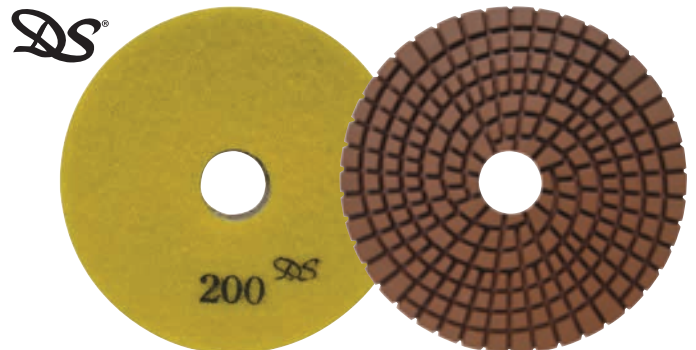

Dongsin® Nautilus 4" Polishing Discs

Designed to polish straight edges and create perfectly flat edges on granite and engineered stone surfaces using C-arm machines.

- QRS connection
- Designed for high performance and long life

Stock No.	Grit	Price
050250	Step 1, 200 Grit.....	\$29.95
050251	Step 2, 400 Grit.....	29.95
050252	Step 3, 800 Grit.....	29.95
050253	Step 4, 1500 Grit.....	29.95
050254	Step 5 Final Buff.....	29.95



Tooling for CMPI, Denver, Marmo Meccanica, Montresor, Sasso Meccanica and more! GranQuartz has diamond tooling for all your automated edging needs. HUNDREDS of TOOLS in stock for immediate delivery with some tooling available as special order only.



Calibrating



Pre-Cut

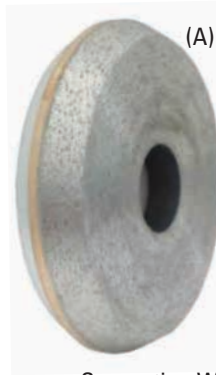

(A)



(B)

Generating Wheels

Comandulli

Stock No.	Description	Machine/Application
919914	Calibrating Wheel, 260mm Dia. x 50+4 Bore	Edilux/PNC/Omega
919903	Calibrating Wheel, 190mm Dia x 50+4 Bore	Musa/Alma/Penta
919935	Pre Cut Wheel, 155mm Dia x 50+4 Bore	Synthesis/Omega
919938	Generating Wheel (A), 130mm Dia , M30 Thread	Synthesis/Omega/PNC
919932	Generating Wheel (B), 130mm Dia , M30 Thread	Synthesis/Omega/PNC

Grooving & Cutting Blades are available by special order.



Calibrating

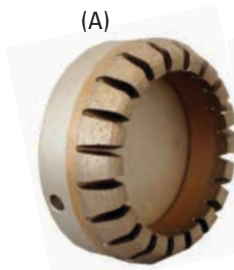

(A)



(B)



(C)

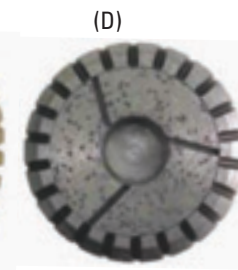

(D)

Pre-Cut Wheels

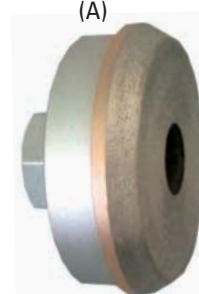

(A)

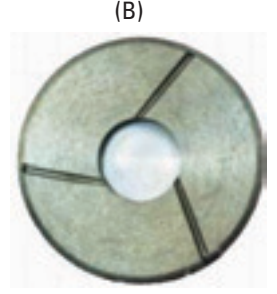

(B)

Generating Wheels

Marmo Meccanica

Stock No.	Description	Machine/Application
919917	Calibrating Wheel, 250mm Dia. x 50mm Bore	LCT/LCV/LCH/LTH
700112	Pre Cut Wheel (A), 130mm Dia. x 18mm x 24mm Thread	LCT/LCV
700028	Pre Cut Wheel (B), 130mm Dia. x 15mm x 24mm Thread	LCT/LCV
996878	Pre Cut Wheel (C), 130mm Dia. Bi-Turbo x 24mm Thread	LCT/LTH
700101	Pre Cut Wheel (D), 150mm Dia. Combi x 24mm Thread	LTH
919955	Generating Wheel (A), 130mm Dia. x 24mm Thread	LCT
700103	Generating Wheel (B), 150mm Dia. x 24mm Thread	LTA/LTH
919971	Frontal Wheel, 130mm Dia. x Snail Lock Conn.	LCT/LCV

Grooving & Cutting Blades are available by special order.



Calibrating



Calibrating & Grooving



Pre Cut



Generating Wheel



Adapter

Sasso Meccanica

Stock No.	Description	Machine/Application
924052	Calibrating Wheel, 130mm Dia. x 95mm Bore	Experience/Full TE
924056	Calibrating & Grooving Wheel, 160mm Dia. x B50+6	Flying Flat/RCM TE
924053	Pre Cut Wheel, 130mm Dia. x 95mm Bore	RCM TE/Experience TE/Full TE
924050	Generating Wheel, 130mm Dia. x 95mm Bore	RCM TE/Experience TE/Full TE
924051	Adapter, 130mm Dia. x 95+6	RCM TE/Experience TE/Full TE

Grooving & Cutting Blades are available by special order.

FOR CMPI, COMANDULLI, BORDI-BRETON, MARMO MECCANICA, RAVELLI

GranQuartz has profile tooling for all your automated edging needs. We stock tooling to fit most major brands of machines including Bordi-Breton, CMPI, Comandulli, Marmo Meccanica, Ravelli & many others. Standard tooling includes profiling wheels, calibrating

wheels, arriasing wheels, and more.

Our huge inventory of Profile Tooling is second to none to ensure your continued workflow; we have hundreds of tools in stock and ready for immediate delivery.

***Some tooling available on a Special Order only basis.**

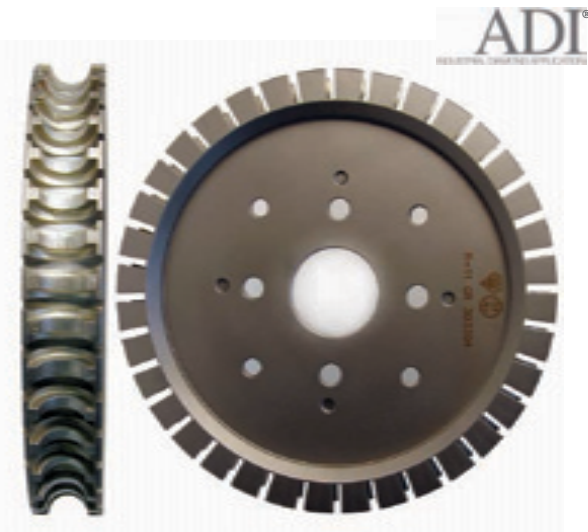

Segmented bullnose wheel
O.D. 250mm, Bore 50mm

Stock No.	Profile	Size	Price
919900	V.....	4cm.....	\$1,175.00
919905	V.....	2cm.....	840.00*
919907	V.....	3cm.....	875.00

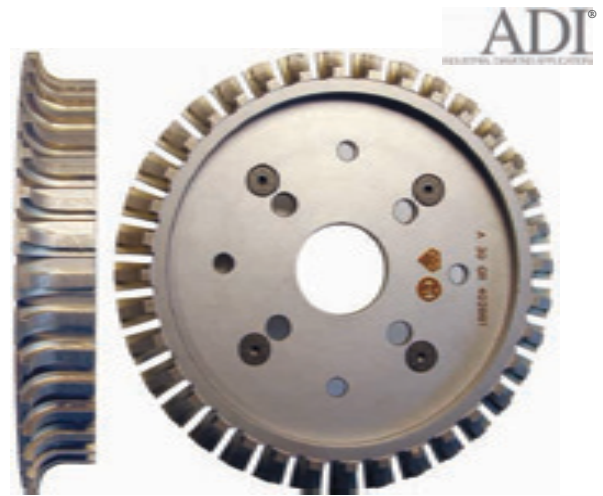

Segmented profile wheel
O.D. 250mm, Bore 50mm

Stock No.	Profile	Size	Price
919920	A.....	2cm	\$895.00*
919922	A.....	3cm	750.00*



Segmented ogee profile wheel
O.D. 250mm, Bore 50mm

Stock No.	Profile	Size	Price
919925	F.....	2cm	\$985.00*
919927	F.....	3cm	965.00*



Segmented half bullnose wheel
O.D. 250mm, Bore 50mm

Stock No.	Profile	Size	Price
919912	B.....	3cm	\$829.00

STRAIGHT EDGE TOOLING

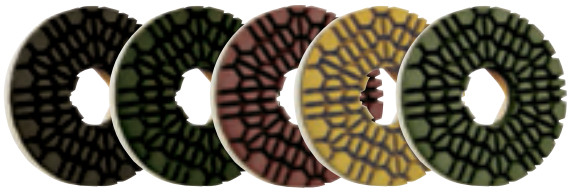

GranQuartz® DIAREX®

Life-Flat Edge	●●●●●
Life-Bullnose	●
Polish	●●●●●

Diarex® Matador Resin Wheels

- For polishing granite, marble, and engineered stone
- Snail-Lock attachment
- 8mm thick

Stock No.	Grit/Description	Price	Stock No.	Grit/Description	Price
117680	50 Copper, 5".....	\$69.95	117686	50 Copper, 6".....	\$96.95
117681	100 Copper, 5".....	69.95	117687	100 Copper, 6".....	96.95
117671	50 Resin, 5".....	61.95	117688	200 Copper, 6".....	96.95
117672	100 Resin, 5".....	61.95	117689	50 Resin, 6".....	74.95
117673	200 Resin, 5".....	61.95	117690	100 Resin, 6".....	74.95
117674	300 Resin, 5".....	61.95	117691	200 Resin, 6".....	74.95
117675	400 Resin, 5".....	61.95	117692	300 Resin, 6".....	74.95
117676	800 Resin, 5".....	61.95	117693	400 Resin, 6".....	74.95
117677	1500 Resin, 5".....	61.95	117694	800 Resin, 6".....	74.95
117678	3000 Resin, 5".....	61.95	117695	1500 Resin, 6".....	74.95
117679	Buff, 5".....	64.99	117696	3000 Resin, 6".....	74.95
			117697	Buff, 6".....	81.00



Diarex® 5" EdgeMaster Resin Turbo Polishing Discs

- For use on automatic edge polishers
- 5" Snail-Lock
- Use for polishing both marble and granite
- 130mm x 40mm hole

Stock No.	Grit	Bond	Price
118632	80.....	Metal/Resin.....	\$189.00
118633	100.....	Resin.....	68.25
118634	200.....	Resin.....	68.25
118635	400.....	Resin.....	68.25
118636	800.....	Resin.....	68.25
118637	1500.....	Resin.....	68.25
118638	3000.....	Resin.....	68.25



Glossfire® Resin Snail Lok Polishing Discs

Stock No.	Grit	Diam.	Price	Stock No.	Grit	Diam.	Price
117816	50.....	4"	\$38.95	117829	Buff/Purple.....	5"	\$49.95
117817	100.....	4"	38.95	117837	30/Copper.....	5"	94.50
117818	200.....	4"	38.95	117838	50/Copper.....	5"	94.50
117819	500.....	4"	38.95	117830	50.....	6"	69.95
117820	1000.....	4"	38.95	117831	100.....	6"	69.95
117821	2000.....	4"	38.95	117832	200.....	6"	69.95
117822	Buff/Purple.....	4"	38.95	117833	500.....	6"	69.95
117823	50.....	5"	49.95	117834	1000.....	6"	69.95
117824	100.....	5"	49.95	117835	2000.....	6"	69.95
117825	200.....	5"	49.95	117836	Buff.....	6"	69.95
117826	500.....	5"	49.95	117840	30/Copper.....	6"	159.95
117827	1000.....	5"	49.95	117841	50/Copper.....	6"	159.95
117828	2000.....	5"	49.95				

Wrenches
 117866 for 4" discs..... \$30.95 117867 for 5"/6" discs..... 30.95

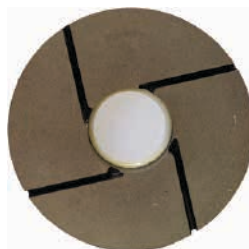

Alpha® Original 4" Twincur Polishing Discs
 With Snail-Lock attachment

Specifically designed for polishing straight and beveled edges using single or multi-head automatic edge polishing machinery.

Stock No.	Grit	Price
900603	100 Resin.....	\$133.97
900604	200 Resin.....	133.97
900605	500 Resin.....	133.97
900606	1000 Resin.....	133.97
900607	2000 Resin.....	133.97
900608	3000 Resin.....	133.97
900609	Buff-Black.....	151.50



Abrasive Technologies® Straight Edge™ Polishing Discs

For polishing straight edges with automated edging machines. Eliminate scratches leaving a perfectly flat polished edge.

- Delivers a better finish in fewer passes
- Snail-Lock Connection
- For edges 3/4" or thicker

Stock No.	Position	Diameter	Price
900331	1.....	4"	\$153.95
900332	2.....	4"	153.95
900333	3.....	4"	125.95
900334	4.....	4"	125.95
900335	Buff.....	4"	59.95



Dongsin® Nautilus Flat Polishing Wheels

- New water channel design evenly distributes water for longer life and high gloss
- Snail Lock connection

Stock No.	Grit/Description	Price	Stock No.	Grit/Description	Price
050322	100 Copper, 130mm.....	\$99.00	050334	100 Copper, 150mm.....	\$116.00
050323	200 Copper, 130mm.....	99.00	050335	200 Copper, 150mm.....	116.00
050327	400 Resin, 130mm.....	58.00	050338	400 Resin, 150mm.....	74.00
050328	800 Resin, 130mm.....	58.00	050339	800 Resin, 150mm.....	74.00
050329	1500 Resin, 130mm.....	58.00	050340	1500 Resin, 150mm.....	74.00
050331	3000 Resin, 130mm.....	58.00	050341	3000 Resin, 150mm.....	74.00



BULLNOSE TOOLING



abrasive technology

Abrasive Technologies® Super-Edge™ Polishing Discs

For polishing bullnose edges on hard or soft stones using automated edging machines.

- Special formulation for long life
- Snail-Lok connection
- Delivers a better finish in fewer passes
- Available in 4" or 5" Diameter discs

Stock No.	Description	Grit	Price
900240	5" Super-Edge	50	\$128.95
900241	5" Super-Edge	120	128.95
900242	5" Super-Edge	220	128.95
900243	5" Super-Edge	400	128.95
900244	5" Super-Edge	600	128.95
900245	5" Super-Edge	800	128.95
900246	5" Super-Edge	1800	128.95
900247	5" Super-Edge	3500	128.95

Stock No.	Description	Grit	Price
900322	4" Super-Edge	50	\$66.95
900323	4" Super-Edge	120	66.95
900324	4" Super-Edge	220	66.95
900325	4" Super-Edge	400	66.95
900326	4" Super-Edge	800	66.95
900327	4" Super-Edge	1800	66.95
900328	4" Super-Edge	3500	66.95

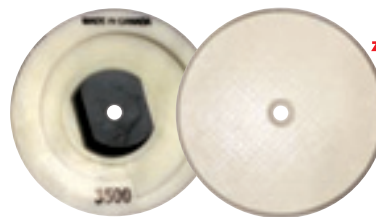

abrasive technology

Abrasive Technologies® Super-Edge™ White Resin Discs

For polishing bullnose edges on hard or soft stones using automated edging machines.

- Special white resin formulation for use on granite or engineered stone
- Snail-Lok connection
- Available in 5" or 6" Diameter discs

Stock No.	Description	Grit	Price
900855	5" White Resin Super-Edge	50	\$128.95
900856	5" White Resin Super-Edge	120	128.95
900857	5" White Resin Super-Edge	220	128.95
900859	5" White Resin Super-Edge	400	128.95
900860	5" White Resin Super-Edge	800	128.95
900861	5" White Resin Super-Edge	1800	128.95
900862	5" White Resin Super-Edge	3500	128.95

Stock No.	Description	Grit	Price
900863	6" White Resin Super-Edge	50	\$164.95
900864	6" White Resin Super-Edge	120	164.95
900865	6" White Resin Super-Edge	220	164.95
900866	6" White Resin Super-Edge	400	164.95
900867	6" White Resin Super-Edge	600	164.95
900868	6" White Resin Super-Edge	800	164.95
900869	6" White Resin Super-Edge	1800	164.95
900870	6" White Resin Super-Edge	3500	164.95

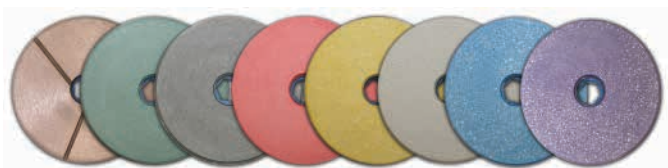

GLOSSFIRE

Glossfire® 5" B-Wheels

Stock No.	Grit	Price	Stock No.	Grit	Price
117844	50	\$59.95	117849	2000	\$59.95
117845	100	59.95	117850	Buff	59.95
117846	200	59.95	117851	100/Copper	99.95
117847	500	59.95	117852	200/Copper	99.95
117848	1000	59.95	117853	Chamfer	94.50



GLOSSFIRE

Glossfire® 6" B-Wheels

Stock No.	Grit	Price	Stock No.	Grit	Price
117857	50	\$99.95	117862	2000	\$99.95
117858	100	99.95	117863	Buff Resin	99.95
117859	200	99.95	117864	100/Copper	144.95
117860	500	99.95	117865	200/Copper	144.95
117861	1000	99.95			

Alpha® 5" Twincur Polishing Discs

Specifically designed to polish bullnose edges on engineered stone surfaces using automatic edge polishing machinery.

- Snail-Lok connection
- Designed for high performance and long life

Stock No.	Grit	Price
900586	200	\$97.12
900587	500	97.12
900588	1000	97.12
900589	2000	97.12
900595	3000	97.12
900596	1000 LC	97.12
900597	2000 LC	97.12

ALPHA®



GranQuartz
DIAREX®



Diarex® ICE Combo Polishing Wheels

For polishing radius and flat edges on granite, marble, and engineered stone surfaces.

- Snail-Lock attachment
- White resin
- 8mm thick

Life-Flat Edge	●●●●
Life-Bullnose	●●●●
Polish	●●●●●●

Stock No.	Description	Price	Stock No.	Description	Price
113720	130mm, 50 Grit.....	\$59.95	113727	150mm, 50 Grit.....	\$89.95
113721	130mm, 100 Grit.....	59.95	113728	150mm, 100 Grit.....	89.95
113722	130mm, 200 Grit.....	59.95	113729	150mm, 200 Grit.....	89.95
113723	130mm, 400 Grit.....	59.95	113730	150mm, 400 Grit.....	89.95
113724	130mm, 800 Grit.....	59.95	113731	150mm, 800 Grit.....	89.95
113725	130mm, 1500 Grit.....	59.95	113732	150mm, 1500 Grit.....	89.95
113726	130mm, 3000 Grit.....	59.95	113733	150mm, 3000 Grit.....	89.95



Diarex® ICE HYBRID Combo Wheels

Grits 50-400 increase the life of the lower grits on radius edge polishing applications. White resin reduces burning and "bleeding" on engineered stone.

- For flat or radius edges on Granite and Engineered Stone surfaces
- Snail-Lock attachment, 8mm thick

**HYBRID TECHNOLOGY
INCREASES LIFE
OF LOWER GRITS!**

Stock No.	Description	Price	Stock No.	Description	Price
113772	130mm, 50 Grit.....	\$67.95	113776	150mm, 50 Grit.....	\$93.50
113773	130mm, 100 Grit.....	67.95	113777	150mm, 100 Grit.....	93.50
113774	130mm, 200 Grit.....	67.95	113778	150mm, 200 Grit.....	93.50
113775	130mm, 400 Grit.....	67.95	113779	150mm, 400 Grit.....	93.50

CYCLONE
FRAMING



Cyclone® "S" FLAT Auto Edge Wheels

Cyclone S flat wheels are a combination of epoxy resin and powder resin that create the perfect wheel for polishing engineered stone and Granite. This special combination gives the tooling great life, and polishing ability at mid/low pressures on any machine that produces flat edges.

Stock No.	Description	Price	Stock No.	Description	Price
601435	5", 60 Grit.....	\$59.00	601442	6", 60 Grit.....	\$73.50
601436	5", 120 Grit.....	59.00	601443	6", 120 Grit.....	73.50
601437	5", 220 Grit.....	59.00	601444	6", 220 Grit.....	73.50
601438	5", 400 Grit.....	59.00	601445	6", 400 Grit.....	73.50
601439	5", 800 Grit.....	59.00	601446	6", 800 Grit.....	73.50
601440	5", 1800 Grit.....	59.00	601447	6", 1800 Grit.....	73.50
601441	5", 3500 Grit.....	59.00	601448	6", 3500 Grit.....	73.50

CYCLONE
FRAMING

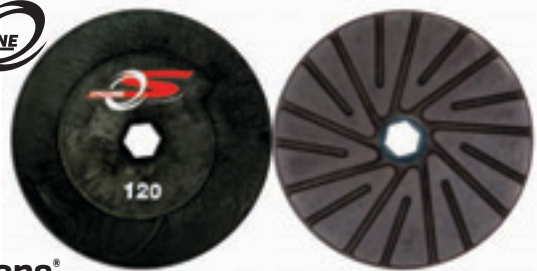

Cyclone® "S" Hybrid Auto Edge Wheels

Cyclone's combination of epoxy resin and powder resin create a perfect wheel for polishing engineered stone and Granite. This formula gives the tooling great life, and polishing ability at mid/low pressures on machines that produce flat edges and radius edges.

Stock No.	Description	Price	Stock No.	Description	Price
601421	5", 60 Grit.....	\$69.00	601428	6", 60 Grit.....	\$98.75
601422	5", 120 Grit.....	69.00	601429	6", 120 Grit.....	98.75
601423	5", 220 Grit.....	69.00	601430	6", 220 Grit.....	98.75
601424	5", 400 Grit.....	69.00	601431	6", 400 Grit.....	98.75
601425	5", 800 Grit.....	69.00	601432	6", 800 Grit.....	98.75
601426	5", 1800 Grit.....	69.00	601433	6", 1800 Grit.....	98.75
601427	5", 3500 Grit.....	69.00	601434	6", 3500 Grit.....	98.75

CYCLONE
FRAMING

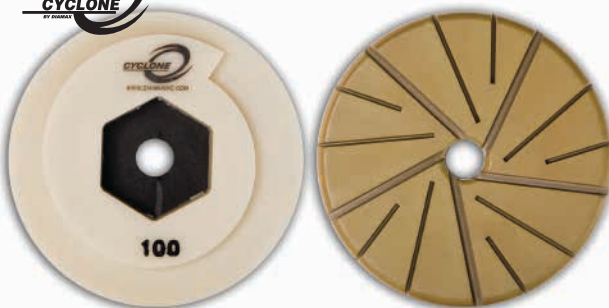

Cyclone® Hybrid Combo Polishing Wheels

- For polishing radius and flat edges on granite, marble, and engineered stone
- Snail-Lock attachment

Stock No.	Description	Price	Stock No.	Description	Price
760085	5", 50, Resin.....	\$72.00	760094	6", 50, Resin.....	\$89.89
760086	5", 100, Resin.....	72.00	760095	6", 100, Resin.....	89.89
760087	5", 200, Resin.....	72.00	760096	6", 200, Resin.....	89.89
760088	5", 400, Resin.....	72.00	760097	6", 400, Resin.....	89.89
760089	5", 800, Resin.....	72.00	760098	6", 800, Resin.....	89.89
760090	5", 1500, Resin.....	72.00	760099	6", 1500, Resin.....	89.89
760091	5", 3000, Resin.....	72.00	760100	6", 3000, Resin.....	89.89
760092	5", Buff Black.....	87.95	760103	6", Buff Black.....	99.95
760093	5", Buff White.....	87.95	760104	6", Buff White.....	99.95



Dongsin® Nautilus Combo Polishing Wheels

- For polishing radius and flat edges on granite, marble, and engineered stone
- Snail-Lock attachment

Stock No.	Description	Price
057168	5", 50, Copper.....	\$99.00
057169	5", 100, Copper.....	99.00
057170	5", 200, Resin.....	69.00
057171	5", 400, Resin.....	69.00
057172	5", 800, Resin.....	69.00
057173	5", 1500, Resin.....	69.00
057174	5", 3000, Resin.....	69.00

Pro Series® FUSION Combo Wheels

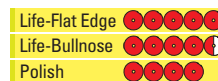

Designed for single pass polishing on both bullnose & flat edges
Designed for Park Velocity Machines.

- Available in 5" or 6" diameter
- Works great on Granite & Engineered Stone
- Snail Lock connection



Stock No.	Diam.	Position	Price	Stock No.	Diam.	Pos.	Price
119896	130mm.....	0	\$59.95	119903	150mm.....	0	\$79.95
119897	130mm.....	1	59.95	119904	150mm.....	1	79.95
119898	130mm.....	2	59.95	119905	150mm.....	2	79.95
119899	130mm.....	3	59.95	119906	150mm.....	3	79.95
119900	130mm.....	4	59.95	119907	150mm.....	4	79.95
119901	130mm.....	5	59.95	119908	150mm.....	5	79.95
119902	130mm.....	6	59.95	119909	150mm.....	6	79.95

Pro Series® NTR² Combo Wheels



For polishing radius and flat edges on Granite & Engineered Stone.

- For polishing granite, marble, and engineered stone
- Use for flat or radius edges
- Snail-Lock attachment



Stock No.	Diam.	Grit	Price	Stock No.	Diam.	Grit	Price
119910	130mm.....	60	\$59.95	119917	150mm.....	60	\$79.95
119911	130mm.....	120	59.95	119918	150mm.....	120	79.95
119912	130mm.....	220	59.95	119919	150mm.....	220	79.95
119913	130mm.....	400	59.95	119920	150mm.....	400	79.95
119914	130mm.....	800	59.95	119921	150mm.....	800	79.95
119915	130mm.....	1500	59.95	119922	150mm.....	1500	79.95
119916	130mm.....	3000	59.95	119923	150mm.....	3000	79.95

Black Magic® Combo Edge Polishing Wheels

Black Magic Combo Edge wheels are excellent for use on all edge machines when producing flat or radius edges. The white resin performs exceptionally well on materials including granite and marble and avoids "burning" engineered stone. For optimal results in shops that produce 50/50 natural stone and quartz surfaces, use the 4 COPPER positions followed by RESIN polishing wheels. For Quartz surfaces, stop with 2,000 Grit.

- For polishing radius and flat edges on granite, marble, and engineered stone
- Snail-Lock attachment



Stock No.	Description	Price	Stock No.	Description	Price
113968	130mm, Pos. 1, Resin.....	\$58.95	113974	150mm, Pos. 1, Resin.....	\$88.95
113969	130mm, Pos. 2, Resin.....	58.95	113975	150mm, Pos. 2, Resin.....	88.95
113970	130mm, Pos. 3, Resin.....	58.95	113976	150mm, Pos. 3, Resin.....	88.95
113971	130mm, Pos. 4, Resin.....	58.95	113977	150mm, Pos. 4, Resin.....	88.95
113972	130mm, Pos. 5, Resin.....	58.95	113978	150mm, Pos. 5, Resin.....	88.95
113973	130mm, Pos. 6, Resin.....	58.95	113979	150mm, Pos. 6, Resin.....	88.95
114158	130mm, Coarse, Copper.....	94.95	114162	150mm, Coarse, Copper.....	128.95
114159	130mm, Medium, Copper.....	94.95	114163	150mm, Medium, Copper....	128.95
114160	130mm, Fine, Copper.....	94.95	114164	150mm, Fine, Copper.....	128.95
114161	130mm, Xtra-Fine, Copper.....	94.95	114165	150mm, Xtra-Fine, Copper.....	128.95

Tenax® Combo Polishing Wheels

Tenax Combo Wheels are excellent for all materials including granite, marble, engineered stone, and porcelain. The wheels are color coded for easy identification, and are available in 10 grits in sequence from 60# to 3000#, 5" & 6" diameters. The light colored resin was specifically designed to work on lighter color engineered stones eliminating resin "bleeding" into material.

- For polishing radius and flat edges on granite, marble, and engineered stone
- Snail-Lock attachment

Stock No.	Description	Price	Stock No.	Description	Price
699224	130mm, 60 Grit.....	\$65.95	699234	150mm, 60 Grit.....	\$82.50
699225	130mm, 120 Grit.....	65.95	699235	150mm, 120 Grit.....	82.50
699226	130mm, 220 Grit.....	65.95	699236	150mm, 220 Grit.....	82.50
699227	130mm, 400 Grit.....	65.95	699237	150mm, 400 Grit.....	82.50
699228	130mm, 600 Grit.....	65.95	699238	150mm, 600 Grit.....	82.50
699229	130mm, 800 Grit.....	65.95	699239	150mm, 800 Grit.....	82.50
699230	130mm, 1200 Grit.....	65.95	699240	150mm, 1200 Grit.....	82.50
699231	130mm, 1500 Grit.....	65.95	699241	150mm, 1500 Grit.....	82.50
699232	130mm, 2000 Grit.....	65.95	699242	150mm, 2000 Grit.....	82.50
699233	130mm, 3000 Grit.....	65.95	699243	150mm, 3000 Grit.....	82.50

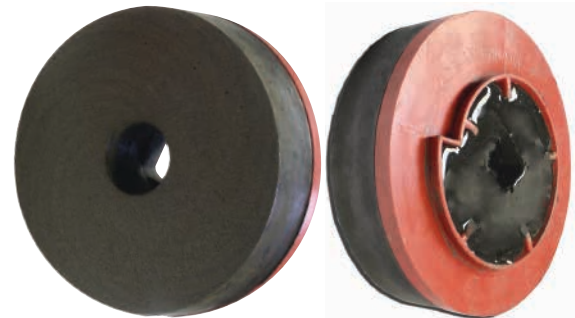

Abressa® Diamond Bullnose Polishing Wheels

- For polishing radius and flat edges on granite, marble, and engineered stone
- Snail-Lock attachment

Stock No.	Description	Price	Stock No.	Description	Price
500261	130mm, 60 Grit.....	\$79.95	500268	150mm, 60 Grit.....	\$102.95
500262	130mm, 100 Grit.....	79.95	500269	150mm, 100 Grit.....	102.95
500263	130mm, 220 Grit.....	79.95	500270	150mm, 220 Grit.....	102.95
500264	130mm, 400 Grit.....	79.95	500271	150mm, 400 Grit.....	102.95
500265	130mm, 800 Grit.....	86.00	500272	150mm, 800 Grit.....	115.50
500266	130mm, 1200 Grit.....	86.00	500273	150mm, 1200 Grit.....	115.50
500267	130mm, 1800 Grit.....	102.90	500274	150mm, 1800 Grit.....	128.00

TENAX



Tenax® Flat Edge Polishing Wheels

- For polishing radius and flat edges on granite, marble, and engineered stone
- Snail-Lock attachment

Stock No.	Description	Price
699165	130mm, 120 Grit.....	\$73.45
699166	130mm, 220 Grit.....	73.45
699167	130mm, 400 Grit.....	73.45
699168	130mm, 600 Grit.....	73.45
699169	130mm, 800 Grit.....	73.45
699170	130mm, 1200 Grit.....	73.45
699171	130mm, 3000 Grit.....	73.45

Adria



Adria® Gladiator Multi-Edge Polishing Wheels

- For polishing radius and flat edges on granite, marble, and engineered stone
- Snail-Lock attachment

Stock No.	Description	Price	Stock No.	Description	Price
363891	130mm, 60 Grit.....	\$79.95	363900	150mm, 60 Grit.....	\$99.95
363892	130mm, 120 Grit.....	79.95	363902	150mm, 120 Grit.....	99.95
363893	130mm, 200 Grit.....	79.95	363904	150mm, 200 Grit.....	99.95
363894	130mm, 300 Grit.....	79.95	363906	150mm, 300 Grit.....	99.95
363895	130mm, 400 Grit.....	79.95	363907	150mm, 400 Grit.....	99.95
363896	130mm, 600 Grit.....	79.95	363909	150mm, 600 Grit.....	99.95
363897	130mm, 800 Grit.....	79.95	363910	150mm, 800 Grit.....	99.95
363898	130mm, 1500 Grit.....	79.95	363912	150mm, 1500 Grit.....	99.95
363899	130mm, 3000 Grit.....	79.95	363914	150mm, 3000 Grit.....	99.95

Adria



Adria® Resin-Diamond Bullnose Polishing Wheels

For polishing radius and flat edges on granite, marble, engineered stone and composite glass and porcelain surfaces.

- Can be used as a flat-edge chamfer wheel
- Snail-Lock attachment

Stock No.	Description	Price
363880	130mm, 60 Grit.....	\$69.95
363882	130mm, 120 Grit.....	69.95
363884	130mm, 200 Grit.....	69.95
363885	130mm, 300 Grit.....	69.95
363886	130mm, 400 Grit.....	69.95
363887	130mm, 600 Grit.....	69.95
363888	130mm, 800 Grit.....	69.95
363889	130mm, 1500 Grit.....	69.95
363890	130mm, 3000 Grit.....	69.95



Adria® Bullnose Polishing Wheels

Long lasting synthetic bullnose wheels can be used on all natural stones.

- Fit all common machines
- Easy setup and installation

Stock No.	Description	Price
363846	100mm, 60 Grit.....	\$6.95
363847	100mm, 120 Grit.....	6.95
363848	100mm, 220 Grit.....	6.95
363849	100mm, 320 Grit.....	8.95
363850	100mm, 400 Grit.....	8.95
363851	100mm, 600 Grit.....	9.95
363852	100mm, 800 Grit.....	11.95
363854	100mm,BUFF,Granite.....	14.95

Stock No.	Description	Price
364102	130mm, 60 Grit.....	\$8.95
364103	130mm, 120 Grit.....	8.95
364104	130mm, 220 Grit.....	8.95
364105	130mm, 320 Grit.....	9.95
364106	130mm, 400 Grit.....	9.95
364107	130mm, 600 Grit.....	10.95
364108	130mm, 800 Grit.....	11.95
364110	130mm,BUFF,Granite.....	14.95

Stock No.	Description	Price
364156	150mm, 60 Grit.....	\$10.95
364157	150mm, 120 Grit.....	10.95
364158	150mm, 220 Grit.....	10.95
364159	150mm, 320 Grit.....	11.95
364160	150mm, 400 Grit.....	11.95
364161	150mm, 600 Grit.....	13.95
364162	150mm, 800 Grit.....	14.95
364164	150mm,BUFF,Granite.....	19.95



Adria® Synthetic Chamfering Wheels

Create a perfect bevel on your finished granite and marble counters

- Produce an excellent polish
- Extremely economical
- 5" Diameter (EZ), Snail Lock

Stock No.	Description	Price
364171	5", 120 Grit.....	\$10.95
364130	5", 220 Grit.....	8.95
364129	5", 400 Grit.....	8.95
364173	5", 600 Grit.....	8.95
364174	5", 800 Grit.....	10.95



Adria® Resin-Diamond Chamfering Wheels

Create a perfect bevel on your finished granite and marble counters

- Produce an excellent polish
- Extremely economical
- 5" Diameter (EZ), Snail Lock

Stock No.	Description	Price
364231	5", 220 Grit.....	\$69.95
364233	5", 400 Grit.....	69.95
364234	5", 600 Grit.....	69.95
364235	5", 800 Grit.....	69.95

ANTIQUING & LEATHERING BRUSHES

Tenax®

Filiflex and Airflex Aging Brushes

Tenax® **Filiflex** brushes remove material aggressively and cut deep into the surface to create antique finishes. Tenax **Airflex** brushes remove the "softer" material in the stone to create a beautiful texture while enhancing the natural color of the stone.

- 4" Diameter Wheels
- 5/8"-11 Arbor with Snail Lock Connections

Stock No.	Description	Grit	Price
800766	Filiflex	36 Grit	\$34.95
800767	Filiflex	46 Grit	34.95
800768	Filiflex	60 Grit	34.95
800769	Airflex.....	120 Grit.....	37.95
800770	Airflex.....	220 Grit.....	37.95
800771	Airflex.....	300 Grit.....	37.95
800772	Airflex.....	400 Grit.....	37.95
800773	Airflex.....	600 Grit.....	43.95



Filiflex Brushes

Airflex Brushes



Alicante Aging Brushes

Ageing brushes for marble, granite and ceramic tile for use with manual, semi-automatic or automatic machinery. Circular ageing wheels available in 100mm with combination Snail Lock/ 5/8"- 11F connection. Color coded grit sequences and stamped grit for easy tool identification.

- 30mm long nylon and silicon carbide abrasive filaments
- Dense concentration of filaments and excellent flexibility
- 36 grit to 1000 grit available for wide variety of finishes, from opaque to mirror
- Mixto brushes utilize 36 grit nylon/silicon carbide center filaments with a stainless steel filament ring for more aggressive polishing
- Inox stainless steel filament brushes used for cleaning the stone

Stock No.	Grit	Price	Stock No.	Grit	Price
800008	24	\$37.20	800018	320	\$37.20
800011	36	37.20	800019	500	37.20
800012	46	37.20	800021	600	44.40
800013	60	37.20	800022	800	44.40
800014	80	37.20	800023	1000	44.40
800015	120	37.20	800024	Mixto	66.45
800016	180	37.20	800025	Inox.....	50.85
800017	240	37.20			



**Master Tre
Fidiflex Finishing Brushes**

Fidiflex Antique/Leather finishing brushes are manufactured with diamond impregnated bristles, greatly extending the working life and aggressiveness of the brush. For use on granite and marble, Fidiflex brushes produce excellent results when matched with Tapflex brushes.

- Snail-Lock connection

Stock No.	Grit	Diameter	Price	Stock No.	Grit	Diameter	Price
800186	30	100mm	\$88.95	800060	30	130mm	\$99.95
800057	40	100mm	88.95	800077	40	130mm	99.95
800058	60	100mm	88.95	800078	60	130mm	99.95
800059	120	100mm	88.95	800079	120	130mm	99.95
800754	220	100mm	88.95	800068	30	150mm	140.95
800755	400	100mm	88.95				
800756	800	100mm	88.95				



Adria Leather/Antique Finishing Wheels

Designed to work with minimal pressure giving increased life while staying sharp. Each grit has a specific color to make it easy to distinguish and recognize.

- Snail Lock Connection
- Made of resin filaments infused with diamond powder
- Allow an increased speed belt for more production and fewer steps

Stock No.	Grit	Diameter	Price	Stock No.	Grit	Diameter	Price
364039	36	100mm	\$69.95	364044	36	130mm	\$99.95
364040	60	100mm	69.95	364046	60	130mm	99.95
364041	120	100mm	69.95	364047	120	130mm	99.95
364042	180	100mm	69.67	364048	180	130mm	99.95
364043	240	100mm	69.95	364049	240	130mm	99.95



Master Tre Tapflex Leather/Antique Finishing Brushes

Tapflex brushes are manufactured with diamond impregnated semi-flexible polishing fins which enhance the color and depth of any antique effect including matte finishes. For face polishing of granite, marble and engineered stone surfaces. Use after Fidiflex brushes for best results.

- Snail lock connection
- Use minimal pressure
- Maximum RPM 1400



Example of leather/antique finished surface

Stock No.	Grit	Diameter	Price
800061	36	5" (130mm)	\$45.95
800062	46	5" (130mm)	45.95
800063	60	5" (130mm)	45.95
800064	120	5" (130mm)	45.95
800065	220	5" (130mm)	45.95
800066	320	5" (130mm)	45.95
800067	400	5" (130mm)	45.95



Nuovo Tapflex Leather/Antique Finishing Brushes

New design for rounded profiles on auto edge machines or hand fabrication. Tapflex Antique/Leather finishing brushes produce excellent results when matched with Fidiflex brushes.

- For hand finishing and edge polishing
- Use with snail-lock adapter
- Great for granite, marble and engineered stone surfaces

Stock No.	Grit	Diameter	Price
800174	60	4" (100mm)	\$38.25
800175	120	4" (100mm)	38.25
800176	220	4" (100mm)	38.25
800177	320	4" (100mm)	38.25
800178	400	4" (100mm)	38.25

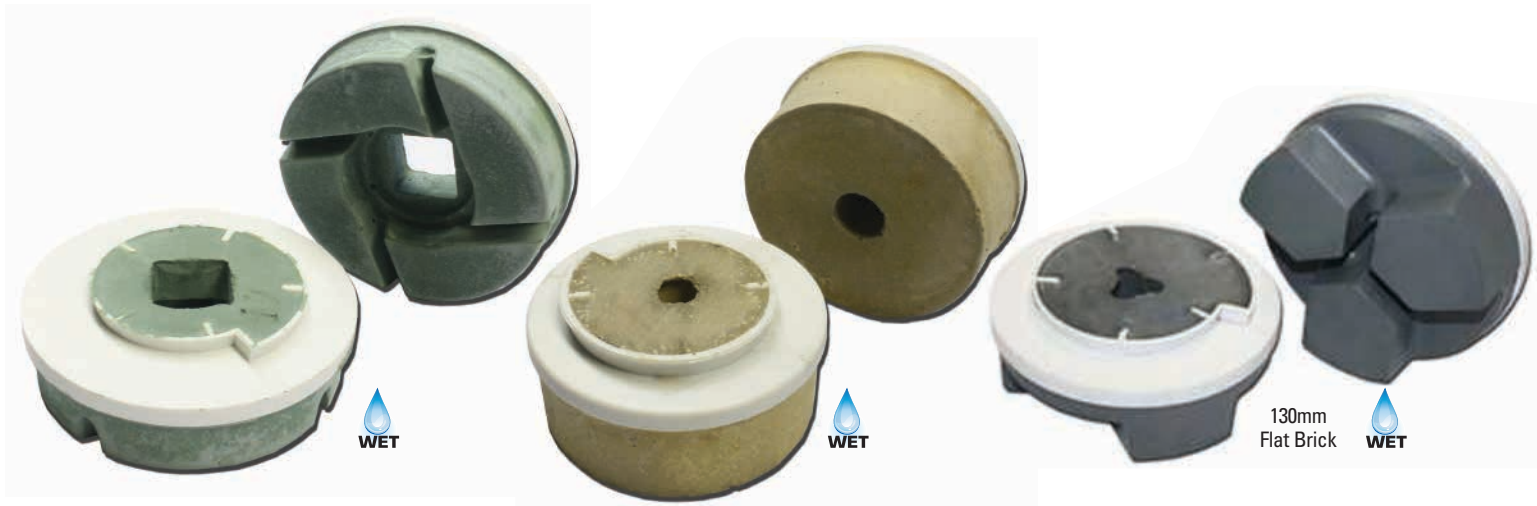

Abressa Resin Bonded Abrasives for Automatic Edge Polishers

Abressa resin bonded abrasives are specifically designed for producing flat edges, bullnoses and chamfering operations with automatic edge polishing systems. Available in 130mm or 150mm diameters.

- “Right-hand” snail-lock connections
- Use Wet
- Perfect for granite & engineered stone

Stock No.	Grit	Price
<i>Flat Edge-130mm</i>		
500211	120 Grit	\$11.15
500212	220 Grit	9.09
500213	280 Grit	9.94
500214	400 Grit	9.94
500215	600 Grit	10.45
500216	800 Grit	12.13
500220	Glossex/Granite.....	19.54

Stock No.	Grit	Price
<i>Chamfer-130mm</i>		
500217	220 Grit	\$13.64
500218	400 Grit	14.67
500219	600 Grit	15.95

Stock No.	Grit	Price
<i>Bullnose-150mm</i>		
500252	60 Grit.....	\$11.22
500253	120 Grit.....	11.75
500254	220 Grit.....	11.75
500255	280 Grit.....	12.56
500256	400 Grit.....	12.56
500257	600 Grit.....	13.22
500258	800 Grit.....	15.03
500259	Glossex/Granite.....	26.42
500260	Synter/Marble.....	26.42

ADAPTERS & COUPLING CONNECTORS



Q.R.S.-Backed Snail-Lock Connection Adapter

With “male” (hook side) Q.R.S. backing

Stock No.	Diam.	Price
999700	4"	\$19.49

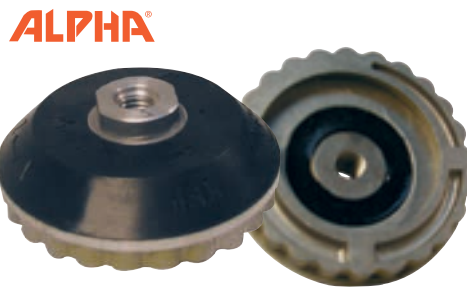

Alpha® Aluminum Snail-Lock Coupling

• With 5/8-11 Female thread

Stock No.	Diameter	Arbor	Price
116158	4"	5/8"-11	\$55.09



Diarex® Aluminum Snail-Lock Coupling

Stock No.	Diameter	Arbor	Price
103953	4"	5/8"-11	\$30.95
103957	5"	5/8"-11	35.15

INCREMENTAL CUTTING BITS



Pro Series® Gold Finger Bit

- 20mm Diameter Segment
- 20mm Height Segment
- Leading diamond technology



Stock No.	Description	Price
116325	20mm x 20mm, M12	\$82.95

Diarex® M12 Incremental Finger Bit

2 new bonds for cutting Granite, Engineered Stone, and Quartzite, with both standard thread & reverse thread.

- 20mm Diameter Segment
- 23mm Height Segment
- M12 Connection



Stock No.	Description	Price
101750	M12 Reverse Thread, Super Soft w/Slot	\$76.95
101751	M12 Super Soft Bond, Continuous Rim	76.95
101752	M12 Quartzite Bond, Continuous Rim	76.95
101753	M12 Reverse Thread Quartzite Bond	76.95



Assassin® Finger Bit

- 20mm Diameter Segment
- 20mm Height Segment
- Great performance at an economical price



Stock No.	Description	Price
100901	20mm x 20mm, M12	\$72.88

Diarex® Red Incremental Finger Bit

- 20mm Diameter Segment
- 20mm Height Segment
- M12 connection



Stock No.	Description	Price
100942	20mm x 20mm, M12	\$78.60



Recon® Incremental Finger Bit

For use on sink cut-out machines.

- 20 x 23mm
- Max RPM: 4,000-9,000
- M12 connection



Stock No.	Description	Price
100750	20mm x 23mm, M12	\$75.90

Dongsin® Twin Segment Finger Bit

Dongsin's new small diameter finger bit if designed for tight radius sinks. Medium bond is especially suited for cutting granite & engineered stone surfaces

- 15 x 37mm
- M12 connection



Stock No.	Description	Price
116788	H20mm/Standard	\$69.95

Super Cyclone® Incremental Finger Bit

For use on sink cut-out machines.

- 20mm Diameter Segment
- 22mm Height Segment
- M12 Connection



Stock No.	Description	Price
693356	M12 Conn	\$72.50
699306	M12 Reverse Thread	72.50

Dongsin® Easy Bit

Incremental finger bit for use with radial arm machines.

- 20mm Height Segment
- M12 connection



Stock No.	Description	Price
122775	H20mm/Standard	\$88.95
122776	H20mm/Turbo	88.95
122777	H20mm/4 Slots	89.95

Speedy Bit Mandrel

5" in length, 1/2 gas connection, made of stainless steel, brass and is center water feed. Use plastic sink templates as a cut-out guide for fast, precise sink cut-outs. Unique features include a hydro port behind the brass bushing to allow for cooling and prevent sediment build up. Replaceable retention cap allows you to use this Mandrel for years.

- Retention cap
- Brass bushing
- Stainless steel mandrel with hydro port

Stock No.	Description	Price
364324	Mandrel	\$142.50
366127	Retention Cap	27.00
366123	Brass Replacement Sleeve	19.95



Mandrels for Grinding Tips

Stock No.	Description	Price
100847	Fingerbit Adapter 1/2 Gas-M12, 31mm	\$107.85
100849	Fingerbit Adapter 1/2 Gas-M12, 49mm	95.95
100848	Replacement Sleeve, 49mm	25.80
116327	For Thibaut 1/2 Gas thread	74.60

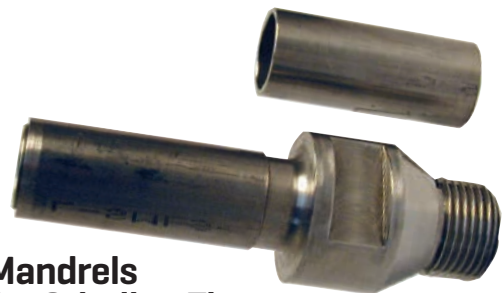

TOP POLISHING/FINISHING BRUSHES



Master Tre Tapflex Leather/Antique Finishing Brushes

Diamond impregnated semi-flexible polishing fins enhance the color and depth of any antique effect including matte finishes. Use after Fidiflex brushes for best results.

Stock No.	Description	Grit	Price	Stock No.	Description	Grit	Price
800092	Frankfurt.....	30....	\$69.30	800096	Frankfurt.....	120..	\$35.15
800093	Frankfurt.....	36.....	35.15	800097	Frankfurt.....	220....	35.15
800094	Frankfurt.....	46.....	35.15	800098	Frankfurt.....	320....	35.15
800095	Frankfurt.....	60.....	35.15	800099	Frankfurt.....	400....	35.15



Alicante Brushes

Ageing brushes for marble, granite and ceramic tile for use with manual, semi-automatic or automatic machinery.

- Made of nylon and silicon carbide abrasive filaments of 30mm in length, guaranteeing longer life

AA Frankfurt Ageing Brushes

Stock No.	Grit	Price	Stock No.	Grit	Price
800026	36	\$28.95	800032	240	\$28.95
800027	46	28.95	800033	320	28.95
800028	60	28.95	800034	500	28.95
800029	80	28.95	800035	600	36.15
800030	120	28.95	800036	800	36.15
800031	180	28.95			

DIAREX



#050007



#050009

#050011

Diarex® Frankfurt Plate System

The Diarex® Frankfurt plate system expands the capability of a CNC Machine investment by providing a means to texture, re-polish, and hone materials. Can be configured in a variety of ways, depending upon the specific application requirements.

Stock No.	Description	Price
050007	Frankfurt Plate w/2 Bolts	\$260.35
050009	Rigid Joint for plate, 1/2" Gas.....	289.95
050011	Spring Adaptor for Plate.....	406.05

Adria



Metal-Diamond Fickert

130 MM

Stock No.	Grit	Price
364442	40-50	\$314.95
364443	60-70	314.95
364251	60-70	314.95
364444	80-100	314.95

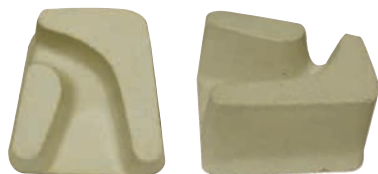

Frankfurt Grinding and Polishing Segments

Sicarex bricks for use on articulated arm, automatic flat polishers and polishing lines on marble or softer granites.

- Some grits are special order

Stock No.	Grit	Price	Stock No.	Grit	Price
104125	24	\$5.40	104129	400.....	\$6.55
104126	60	5.40	104130	600.....	9.85
104127	120	5.40	104131	600/800..	10.80
104128	280	5.40	104132	Polisher ...	15.80

Adria



Adria® Frankfurt Bricks for Granite

Highest quality Frankfurt bricks for polishing granite.

MEDIUM BOND

Stock No.	Grit/Use	Price
364183	46 Grit(Grind).....	\$2.89
364184	60 Grit(Grind).....	2.89
364185	80 Grit(Hone).....	2.89
364186	120 Grit(Hone).....	2.89
364187	180 Grit(Hone).....	2.99
364188	220 Grit(Hone).....	2.99

MEDIUM BOND

Stock No.	Grit/Use	Price
364189	320 Grit(Hone)...	\$2.99
364190	400 Grit(Polish)....	3.99
364191	600 Grit(Polish)....	3.99
364192	800 Grit(Polish)....	3.99
364193	1000 Grit(Polish) .	3.99

Adria

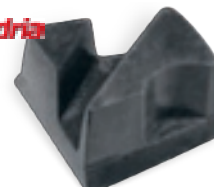

Adria® Final Buff Bricks for Granite

For polishing granite to a high lustre.

Stock No.	Description	Price
364194	Buff/Granite.....	\$13.99

Adria



Adria® Magnesite Fickert for Granite

Highest quality Fickert bricks for polishing granite.

Stock No.	Grit	Price	Stock No.	Grit	Price
364131	36.....	\$3.95	364136	220..	\$3.95
364268	46.....	3.95	364137	320....	4.95
364132	60.....	3.95	364138	400....	4.95
364133	80.....	3.95	364139	600....	6.95
364134	120....	3.95	364140	800....	7.95
364135	180....	3.95	364141	1200..	8.95

Adria



Marble Honing Brick

Final step for honing marble leaves the stone with a consistently beautiful finish.

Stock No.	Description	Price
364182	Honing Brick.....	\$20.95

Adria



Granite Buff Fickert

Stock No.	Grit	Price
364258	220	\$12.95
364224	220	12.95
364250	220	12.95
364142	220	12.95

Adria



Resin Diamond Fickert for Granite

Stock No.	Grit	Price	Stock No.	Grit	Price
364217	120.	\$58.95	364221	600.	\$58.95
364236	150....	58.95	364222	800....	58.95
364218	200....	58.95	364223	1500..	58.95
364219	320....	58.95	367440	3000..	58.95
364220	400....	58.95			

Adria



5X Extra Marble Buff Brick

Final step for polishing marble.

Stock No.	Description	Price
364169	5X Marble Buff	\$12.95

Adria



Marble White Cleaning Brick

For removing residue and adding shine.

Stock No.	Description	Price
364195	Marble White.....	\$4.95

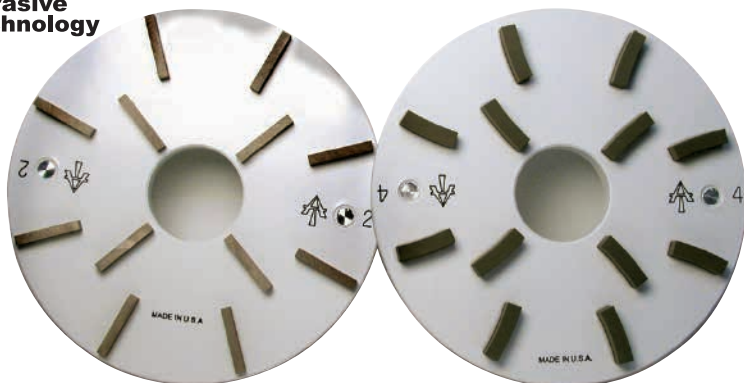

Abrasive Technology SlabMaster Polishing Discs

For Granite and Marble.

8" for Park Wizard			10" for Park Wizard			10" Standard		
Stock No.	Position	Price	Stock No.	Position	Price	Stock No.	Position	Price
900265	1	\$360.13	900260	1	\$573.72	900255	1	\$573.72
900266	2	360.13	900261	2	573.72	900256	2	573.72
900267	3	301.52	900262	3	433.65	900257	3	433.65
900268	4	301.52	900263	4	433.65	900258	4	433.65
900269	5	301.52	900264	5	232.93	900259	5	232.93
900270	6	301.52	900291	6	232.93	900296	6	232.93
900271	Buff	240.35	900273	Buff	131.82	900297	BuffMarble	131.82



Dongsin® Metal 10" Top Polishing Discs

- Grinding with high quality finish
- For Granite, Marble & Engineered Stone
- Synthetic Metal Disc
- 10" Screw (WZ), N12 Connection

Stock No.	Grit	Price
122932	30G	\$349.95
122931	50G	349.95
122925	100G	349.95
122926	200G	349.95
122927	400G	349.95

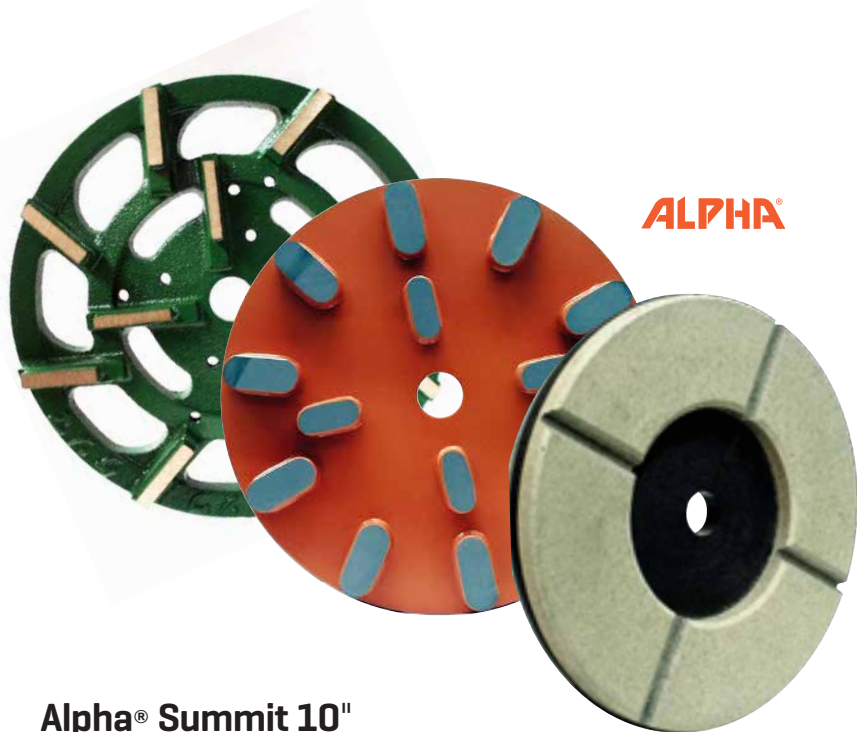

ALPHA®

Alpha® Summit 10" Granite Polishing System

For radial arm polishing machines.

Stock No.	Grit/Type	Price	Stock No.	Grit/Type	Price
933470	80, Metal	\$523.33	933475	1000, Resin	\$347.56
933471	200, Metal	523.33	933476	2000, Resin	347.56
933472	400, Metal	523.33	933477	3000, Resin	347.56
933473	200, Resin	347.56	933478	Final Polish White	396.54
933474	500, Resin	347.56	933479	Final Polish Black	396.54



Dongsin® Resin 10" Top Polishing Discs

Engineered for smooth operation while top polishing granite, marble and engineered stone surfaces.

- Connection for Park Wizard

Stock No.	Description	Price
122803	N15 50G	\$279.95
122790	N15 100G	279.95
122791	N15 200G	279.95
122792	N15 300G	279.95
122793	N15 400G	279.95
122794	N15 500G	279.95
122795	N15 600G	279.95
122796	N15 800G	279.95
Stock No.	Description	Price
122797	N15 1000G	\$279.95
122798	N15 1500G	279.95
122799	N15 2000G	279.95
122800	N15 3000G	279.95
122801	N15 6500G	279.95
122771	N15 Black	299.95
123086	N15 Gray	299.95
123087	N15 White	299.95

BUSH HAMMER PLATE & DRUM GRINDERS

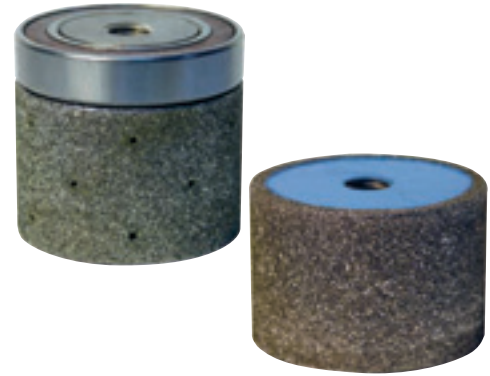

Electroplated Drum Grinders

• 5/8" - 11 female threaded

Stock Number	Diam.	Width	Grit	Center Water Fed	Bearing Guide	Price
934217	5/8"	1 1/2"	30/40	Yes	N/A	\$119.00
934206	1 1/2"	2"	30/40	No	N/A	\$217.95
910916	2"	2"	30/40	Yes	Yes	\$339.00
910920	3"	2"	30/40	Yes	Top	\$463.00
921313	3"	2"	30/40	Yes	N/A	\$465.00

Bush Hammer Plates

Stock No.	#Rollers	Diam.	RPM	Connection	Price
600100	3	4"	800	5/8 - 18 male	\$729.95
600150	4	6"	800	5/8 - 18 male	705.00
600440	24	24"	500-600	M30 x 3.5	5,600.00

Spare Rollers

Stock No.	For Plates	Price
600090	4 x 6"	\$149.00

Spare Forks

Stock No.	For Plates	Price
600092	4 x 6"	\$32.00

GranQuartz DIAREX®



Diarex® Vacuum Brazed Sink Drums

CNC Connection:

Stock Number	Diameter	Grit	Connection	RPM	Feed Removal	Price
910901	1" x 2"	50	1/2" gas	5,500	30" .. 0.015"	\$88.95
910902	1" x 2"	100	1/2" gas	5,500	30" .. 0.010"	92.95
910905	1" x 2"	200	1/2" gas	5,500	30" .. 0.005"	92.95
910903	2" x 2"	50	1/2" gas	5,500	30" .. 0.015"	94.95
910904	2" x 2"	100	1/2" gas	5,500	30" .. 0.010"	99.30
910906	2" x 2"	200	1/2" gas	5,500	30" .. 0.005"	99.30
901851	1/2" x 2"	200	1/2" gas	6,000	20" .. 0.015"	80.25
901852	1/2" x 2"	200	1/2" gas	6,000	20" .. 0.010"	80.25
901853	1/2" x 2"	200	1/2" gas	6,000	20" .. 0.005"	80.25

Hand Held Connection:

Stock Number	Diameter	Grit	Connection	RPM	Price
910907	1" x 2"	50	5/8" - 11	5,500	\$93.55
910908	1" x 2"	100	5/8" - 11	5,500	93.55
910909	1" x 2"	200	5/8" - 11	5,500	93.55
910910	2" x 2"	50	5/8" - 11	5,500	99.95
910911	2" x 2"	100	5/8" - 11	5,500	99.95

Vacuum Brazed Drum Grinders

With top bearing and 5/8" - 11 female thread



Stock Number	Diameter	Grit	Price
694705	1"	40	\$165.95
694706	1"	80	160.00
694707	3"	30	185.95
694708	3"	40	207.95
694709	3"	80	205.95



Diarex® Vacuum Brazed Sink Drums

Stock Number	Diameter	Grit	Connection	Price
901848	1/2" x 2"	FINE	5/8-11	\$84.65
901849	1/2" x 2"	MED	5/8-11	84.65
901850	1/2" x 2"	COARSE	5/8-11	84.65



Stock Number	Diameter	Grit	Connection	Price
901851	1/2" x 2"	FINE	1/2" Gas	\$80.25
901852	1/2" x 2"	MED	1/2" Gas	80.25
901853	1/2" x 2"	COARSE	1/2" Gas	80.25

MILLING DRUMS, GRINDING WHEELS

**Pro Series®
Vacuum Brazed
Milling Drums
with Top Bearing**



Stock Number	Diameter	Grit	Conn.	Price
910980	2"x2"	30	5/8"-11	\$124.95
910981	2"x2"	50	5/8"-11	124.95
910982	2"x2"	100	5/8"-11	115.95
910985	3"x1.5"	50	5/8"-11	132.95
910988	3"x2"	30	5/8"-11	141.95

(All include bearing)



**Dongsin®
Zero Tolerance
Resin Filled Grinding Wheels**

New and improved design with 1 3/4" (45mm) segment height, can be used wet or dry.

- 2" or 3" Diameter
- 5/8"-11 Female Thread

Stock No.	Diam./Grit	Arbor	Price
122195	2", 40 Grit	5/8"-11	\$115.00
122200	3", 40 Grit	5/8"-11	139.95
122190	2", 100 Grit	5/8"-11	113.00
122198	3", 100 Grit	5/8"-11	139.95

**Sintered
Sink Truing Wheels**

For grinding/truing of sink openings in marble and granite.

- 5/8"-11 Female Thread



Stock No.	Desc.	Grit	Price
698376	2"	36	\$119.95
698377	2"	60	119.95
698378	2"	120	119.95
698379	2"	220	119.95
118520	3x 1 1/2"	36	145.95
118521	3x 1 1/2"	60	140.99



**Pro Series®
Zero Tolerance Drums**

- Designed for wet or dry use
- Coarse matrix for aggressive grinding
- 1 5/8" length, 5/8"-11 Female Thread

Stock No.	Diam.	Price
800335	1"	\$93.55
800336	2"	103.95
800337	3"	124.95
800338	4"	145.00



**Dongsin®
Zero Tolerance Grinding Drums**

- Segmented Drum
- 2" Diameter
- 5/8"-11 Female Thread

Stock No.	Diam./Grit	Arbor	Price
122170	2", 50 Grit	5/8"-11 Thread	\$110.95
122171	2", 100 Grit	5/8"-11 Thread	117.95

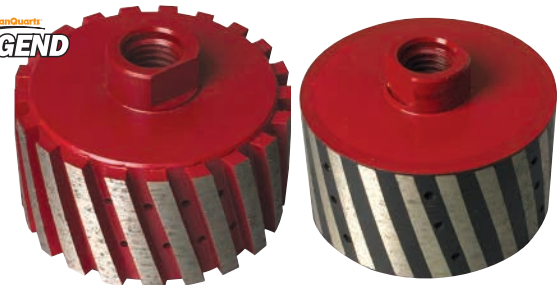

**Legend® Zero Tolerance
Grinding Drums**

- Available in Segmented or Resin-Filled Drum
- For Wet or Dry use
- 1 5/8" Height, 5/8"-11 Female Thread

Stock No.	Diam./Grit	Arbor	Price
698407	1", Segmented	5/8"-11 Thread	\$89.95
698408	2", Segmented	5/8"-11 Thread	93.50
698410	3", Segmented	5/8"-11 Thread	114.50
698409	2", Resin-Filled	5/8"-11 Thread	112.00
698411	3", Resin-Filled	5/8"-11 Thread	135.00

**Cyclone® Zero Tolerance
Grinding Drums**

Designed with waterfeed holes for wet or dry use, balanced and resin-filled for zero vibration (1" non-resin filled).

- Vertical oscillation recommended for faster stock removal and even wear
- Coarse matrix for aggressive grinding



Stock No.	Diam.	Arbor	Price
600274	1"	5/8"-11 Thread	\$99.95
600267	2"	5/8"-11 Thread	109.95
600268	3"	5/8"-11 Thread	129.95

BREATHE EASY.

Duroair Filtration Systems EXCEED OSHA REQUIREMENTS! **Duroair™**
the evolution of air

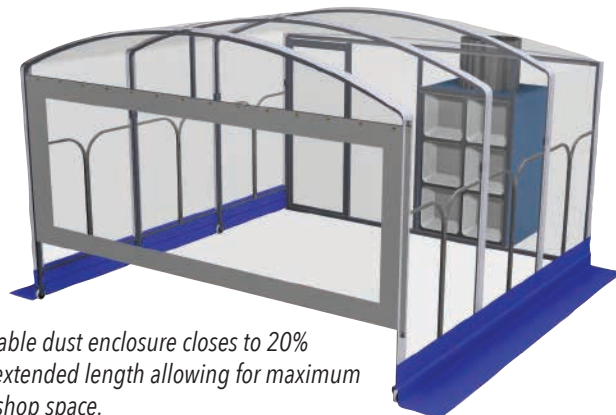

Retractable dust enclosure closes to 20% of the extended length allowing for maximum use of shop space.

Duroair Dust Containment System

Duroair's Silica Dry Dust Collection System is a fully enclosed work space that is modular, portable and retractable. The Duroair enclosure retracts down to 20% of length for easy handling and portability. Negative pressure pulls all particulates into the system's 4-stage, Merv15* filtration system with the air leaving the system exceeding OSHA requirements.

- Captures all particulates to 1 micron
- 8 air changes per minute, airflow 150 feet/minute
- 30" Fan, 10 HP with variable fan speed
- 14 1/2' x 14 1/2' x 8' Tall when fully extended
- Can be easily moved around shop space

*Minimum Efficiency Reporting Value 15

Stock No.	Description	Price
491037	10Hp, 230V, 3-Phase.....	\$19,999.00
491038	10Hp, 230V, Single-Phase	21,500.00
491043	10Hp, 480V, 3-Phase.....	19,999.00

4-Stage, Merv15* Filtration Unit with Self-Cleaning Filters

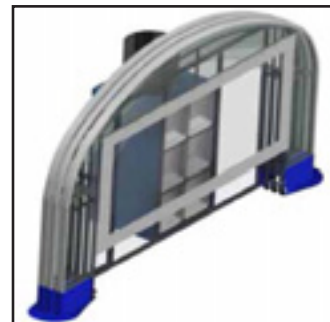
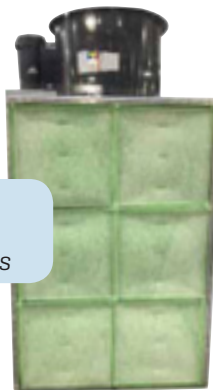

DuroTower Auto Adjusting Plant Cleaning Systems

Fabrication processes produce dust and fumes that have been associated with impaired health which translates to decreased productivity. DuroTower efficiently collects these dangerous contaminants and fills the space with clean air from the system outlet and can be used with a DuroRoom™ for effective clean room, isolation room, or dust collection applications. The DuroTower is a cost-effective air revolver system that is ten times more energy efficient than traditional overhead dust purification systems. Flexible with multi-tower models that can be outfitted with casters for portability and environmentally compliant with air rotation technology that removes airborne particles down to 1 micron. DuroTower reduces energy costs through the de-stratification of heat layers, homogenizing air from floor to ceiling to within 5 degrees.

- 8,000 - 30,000 CFM design range
- Small footprint: 40" x 50"
- Available height options of 11' or 14'
- Power: Three phase 208-230/460 volt
- Multiple filter stages for various contaminant situations
- 10 and 16 gauge welded steel construction
- Industrial enamel finish
- Easy two-section installation

Stock No.	Description	Price
491040	AR8000-S (8000 CFM/8'-10")	\$17,500.00
491041	AR8000 (8000 CFM/10'-10")	17,500.00
491042	AR15000-S (15,000 CFM/13'- 3")	23,599.00
491039	Caster Wheel Set	399.00

World's First Auto-Adjusting Plant Cleaning System Using State of the Art Air Rotation Process

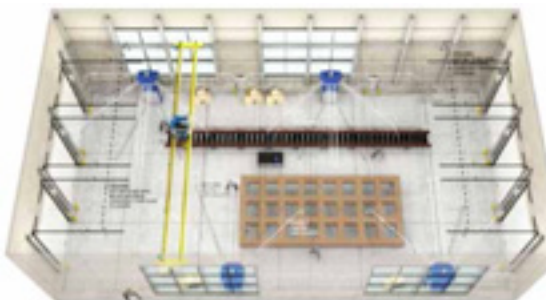

Energy-Efficient Air Purification for the Entire Shop Floor





Weha Dry Wall Dust Collector

The WEHA Filter Project Clean Air Dry Dust Collection Booths provide a major advantage in removing silica dust from the air. Weha Dry Dust Collectors vacuum air from the bottom of the unit so that the air flow is coming from below the knees, creating a downward pull of air. The major advantage of this air flow movement is that the dust is pulled down from the work table immediately away from the face. This design is the absolute best way to reduce as much dust from the workers as fast as possible.

- Especially suited for extracting silica dust
- Automatic Self-Clean mode for easy maintenance
- Dust settles in drawers located at the bottom of the unit

Stock No.	Description	Price
060603	Dry Dust Wall 3 Meter, 4HP 220/3-Phase	\$18,950.00
060604	Dry Dust Wall 4 Meter, 8HP 220/3-Phase	21,600.00



Weha Water Wall Dust Collector

With the additional requirements initiated by OSHA for Silica in the granite and engineered stone, the Filter Project Clean Air Water Collection Booth will be a major advantage in removing silica dust from the air. The operation of the Water Wall Dust Collector is extremely easy- push the button and work in front of it. The dust will be vacuumed horizontally into the water wall without the fabricator breathing any of the dust. Designed to trap 99% of granite dust, marble dust, engineered stone dust, quartz dust, concrete dust, natural stone dust, and other fine airborne particles.

- Electrical requirements: 220 (208) 3 phase, 20 Amp breaker
- Water requirements: 400 gallons

Stock No.	Description	Price
060601	Water Dust Wall 3 Meter, 5.5HP 220/3-Phase	\$14,720.00
060602	Water Dust Wall 4 Meter, 8HP 220/3-Phase	16,550.00



Novair 1000 Portable HEPA Air Filtration System

The Novair 1000 is a light, compact HEPA filtration system for use anywhere dust is a concern.

- 1000 cubic feet per minute with filters in place
- Powerful 1 HP, 2-speed motor
- Vertical "hand truck" profile with non-marring skids & wheels
- Utilizes HEPA filters or Nuisance dust filters
- Polyethylene, dent-proof shell
- Small footprint is great for tighter work areas
- With Audible & visual alarm

Stock No.	Description	Price
104090	Novair 1000 Filtration System (No Alarm)	\$809.00
104092	Ring Filter, 16" x 16"	5.95
104093	Pad Filter, 16" x 16"	1.95
104094	0.3 Micron HEPA Filter, 16x16x11.5"	150.95
104095	GP Filter Kit to Convert from HEPA	216.95
104096	GP Replacement 0.5 Micron Filter 16x16x11.5"	60.95



Novair 2000 Portable HEPA Air Filtration System

The Novair 2000 is a light, compact HEPA filtration system for use anywhere dust is a concern. Available in a variety of power sources (110v-220v 50/60Hz) and filter configurations. Easy to decontaminate or clean.

- True 2000 cubic feet per minute with filters in place
- Powerful 2 HP/115V motor with audible & visual alarm
- Horizontal configuration
- Utilizes HEPA filters or Nuisance dust filters
- Polyethylene shell w/integrated molded carrying handles
- Caster nest for stacking & inset channel for strapping

Stock No.	Description	Price
104080	Novair 2000 Filtration System (No Alarm)	\$989.00
104082	Ring Filter, 24 x 24"	5.95
104083	Pad Filter, 24 x 24	1.95
104084	0.3 Micron HEPA Filter, 24 x 24 x 11.5"	185.95
104085	GP Filter Kit to Convert from HEPA	219.95
104086	GP Replacement 0.5 Micron Filter 24x24x11.5"	67.95



Metabo® ASR35 HEPA Wet/Dry Vacuum

The METABO ASR35 ACP Vacuum meets or exceeds all regulatory standards concerning HEPA vacuums and provides the highest level of job-site dust containment. The ASR35 ACP is made in Germany. Use for extraction from the power tool in continuous mode, both on construction sites and in the workshop, this compact vacuum cleaner is great for removal of liquids and dry solids. Utilizes AutoCleanPlus to save costs and time thanks to automatic MPulse filter cleaning allowing for continuous use. If the vacuum senses a pressure difference from one side of the filters to the other, the filters are vibrated immediately, clearing the filters without interrupting suction.

- Especially suited for extracting concrete and rock dust
- Suction power control for adapted suction performance
- Power socket- vacuum starts automatically when a tool plugged into the tool outlet is turned on
- Twin polyester filter cassettes with large filter area for constantly high suction capacity

Stock No.	Description	Price
569374	Metabo ASR35 ACP Vacuum	\$699.99
630343	9 Gal. Pre-Filter Bags, 5-PK.....	38.20
630325	Pre-Collection Bags, 5-PK.....	68.77
631935	Paper Filter Collection Bags, 5-PK.....	46.40
631934	Polyester Filter Set, 2.....	196.06
630326	HEPA Filter Set, 2.....	281.15

Makita® VC4710 XTRACT 12 Gallon HEPA Wet/Dry Vacuum



A powerful 12 AMP motor generates 135 CFM of suction power and 92" of water lift to take on the most challenging applications.

Motor chamber is constructed of quality sound-absorbing materials resulting in a quiet operating sound level of 59 dB(A). Automatic Filter Cleaning System with blow-back feature is timed at set intervals to maintain filter performance for longer filter life.

- 126 CFM
- 35 lbs.
- 120V / 11.5 AMP
- Holds up to 40 lbs. of dust & debris



Stock No.	Description	Price
471000	HEPA 12 Gal. Vacuum.....	\$663.95

Dustless Technologies® 16 Gallon HEPA Wet/Dry Vacuum

Dustless Technologies' 16 Gallon HEPA Wet/Dry Vacuum enables you to switch from dry to wet operation without danger of getting the valuable HEPA filter wet. A protective baffle/wall inside the canister protects the HEPA filter from water. Comes with 2 extension wands, 1 HEPA filter and cover, 2 Wunderbag micro pre-filter, 1 service tool and 1 floor tool.

- 126 CFM
- 35 lbs.
- 120V / 11.5 AMP
- Holds up to 40 lbs. of dust & debris



Stock No.	Description	Price
160600	HEPA 16 Gal. Vacuum w/12ft. Hose.....	\$608.99
132010	Wet/Dry HEPA Filter	167.95

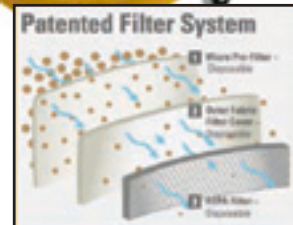

Aztec® ProScrub Automatic Floor Scrubber

Wet scrub and dry vacuum in one pass. The brush-driven ProScrub is inexpensive to purchase and maintain. Fast and efficient, it's very user friendly, with a 24 volt system that delivers approximately 3 hours run time when fully charged.

- Wet scrub and dry vacuum in one pass
- 12 Gallon solution tank with 15 gallon recovery tank
- 3/4 hp Brush motor, 220 RPM
- 1/2 hp, 24 volt Vacuum motor
- 65 lb. Scrubbing pressure

Stock No.	Description	Price
030200	Aztec Auto Scrubber.....	\$4,075.00





ALPHA

NEW!

Alpha® EcoGuard W6

Designed for collecting dust when grinding with wheels up to 6" in diameter. EcoGuard W6 creates a virtually dust-free environment when connected to a vacuum.

- Clear cover for better visibility
- Easy to install and replace grinding wheels

Stock No.	Description	Price
933566	EG W6 w/Connector Hose Kit.....	\$147.20
526000	Flexible Tapered Hose Kit, 18" L.....	16.00



ALPHA

Alpha® EcoGuard

Designed for collecting dust when using a high-speed angle grinder and grinding wheels up to 5" in diameter. High-quality composite construction is perfectly suited for even heavy duty applications. The EcoGuard G's cover helps to eliminate almost all dust in your work environment when connected to a vacuum.

- Clear cover for better visibility
- Easy to install and replace grinding wheels
- Removable front piece for edge grinding

Stock No.	Description	Price
933560	EcoGuard Type G	\$116.75
933558	EcoGuard Type G w/Connector Hose Kit.....	135.70



CutBuddie™

Dust Containment Shroud for use with hand grinders.

- Fits most 4" and 5" grinders
- Fast, easy installation using bracket band and clamp combination
- Clear polycarbonate for durability and visibility
- Captures up to 99% of airborne dust

Stock No.	Description	Price
114949	5" Cutbuddie w/18" Hose.....	\$104.95
001750	7" Cutbuddie w/18" Hose.....	115.95



DustBuddie™

Dust Containment Shroud for hand grinders.

- Fits most 4" - 5" hand grinders
- Removable front edge of shroud for grinding close to wall or edge
- Brush skirt for improved performance on textured surface

Stock No.	Description	Price
114922	5" dia. x 18" x 1.5" Hose	\$83.95
114923	7" dia. x 18" x 1.5" Hose	88.15

Pearl® Dust Cover for 4 1/2"-5" Grinders

For effective dust control when grinding concrete, masonry, mortar and other hard surfaces producing dust.

- Fits 4 1/2" - 5" grinders including Milwaukee, Dewalt, Metabo, Makita, and Bosch
- Includes: Clamp, Cup nut assembly

Stock No.	Price
677350.....	\$72.95



PEARL

Pearl® Hinged Dust Cover

Hinged front for grinding against walls & edges. Effective dust control when grinding concrete, masonry, mortar.

- Fits 7" and 9" grinders including Milwaukee, Dewalt, Metabo, Makita, and Bosch
- Includes: Clamp, 5 Shroud spacers

Stock No.	Description	Price
677354.....	Dust Cover, 7" Hinged Port ...	\$84.95
677356.....	Dust Cover, 7" Slide Port.....	84.95



PEARL



Ermator® 7" Deluxe Dust Shroud

Dust Shroud attachment collar with multiple rings to allow the dust shroud to be attached to most common hand grinders.

- Swivel for attachment of 1.5" and 2" hoses
- Flexible rubber flange for working contours
- Flip up wall hinge can be folded up and clear of walls while working corners
- Vent hole to adjust suction

Stock No.	Price
869839.....	\$192.78



Particulate Respirator

- NIOSH approved, N95
- Adjustable nose piece w/foam cushion
- 20 masks per box

340017.....\$15.59



Moldex® 2200N95 Disposable Respirator

Softspun® lining gives added comfort and durability.

- Dura-Mesh™ shell protects filter.
- 20 per box.

340025.....\$28.79

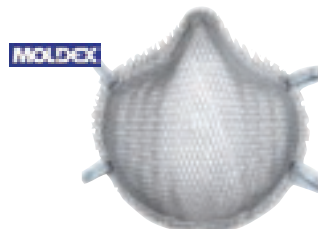

Moldex® 1200N95 Dirt Dawg® Dust Mask

- Specially designed for stone dust
- N95 Rating
- 20 per box

340013.....\$27.45



Moldex® 2300N95 Disposable Respirator

Exhale valve reduces hot air build-up, keeping workers cooler and more comfortable.

- 100% PVC-Free
- Ventex™ exhale valve
- N95
- 10 per box.

Stock No.	Description	Price/Box
100070	Moldex 2300N95.....	\$32.83



Moldex® 2700N Dust Masks

- Handy Strap™ with buckle for quick release of mask
- Ventex® valve lets hot air out faster so workers breath easier and stay cooler
- N95
- 10 per box.

Stock No.	Description	Price/Box
340024	Moldex2700N	\$46.08



3M™ Particulate Respirator 8210

- Welded strap attachment
- Cushioning nose foam
- Adjustable nose clip helps provide a custom fit and secure seal

Stock No.	Description	Price/Box
696109	3M 8210.....	\$20.40



Moldex® 7000/7800 Series Respirators

7000 and 7800 Series respirators are lightweight with an extra-wide sealing area for all day comfort and safety. Mask drops down for storage around neck while not in use, or locks down for a custom fit.

Stock No.	Description	Price
794100	Model 7000 w/P100 Filters, SMALL.....	\$29.35
794200	Moldex 7000 w/P100 Filters, MED.....	29.35
794300	Moldex 7000 w/P100 Filters, LARGE.....	29.35
794000*	Moldex P100 Filters (Pair).....	11.29
007801	Moldex 7800 Premium Mask, SMALL.....	38.17
007802	Moldex 7800 Premium Mask, MED.....	38.17
007803	Moldex 7800 Premium Mask, LARGE.....	38.17
792000	Moldex Piggyback Adaptor	6.41
710000	Moldex Organic Vapor Cartridges (2).....	16.15

***#794000 P100 Filters can be used w/ Series 7000, 7800 & 9000 respirators**

#007801
(Shown w/#794100 Filters, sold separately)



#710000
Organic Vapor Cartridges



#792000
Adaptor



Silica Danger Shop Sign

Make sure hazardous areas of your workplace are clearly designated with this silica warning sign.

- 10" x 14" reusable plastic sign
- Includes 4 holes for mounting but no screws

Stock No.	Description	Price
102320	"Danger" Sign	\$12.99

Moldex® 9000 Series Full Face Respirators

Moldex 9000 full face respirators feature an exclusive over-molded lens design eliminating a heavy clamping frame for a full face with lighter weight, greater field of vision, fewer parts, minimal maintenance and completely free of metal parts.

- Ultra-lightweight comfort
- Strap buckles are securely molded to facepiece
- Coated lens is scratch resistant

Stock No.	Description	Price
009002	9000 Facepiece Only, MED.	\$160.46
794000	Moldex P100 Filters (Pair).....	11.29



#009002

Moldex® Bitrex Qualitative Fit Test Kit

Make sure your respirator is fitted for a tight seal to ensure safety against hazards in the workplace with the Bitrex Qualitative Fit test Kit.

- Kit includes: (2) Nebulisers, test hood, (6) 2.5ml ampules Bitrex™ Sensitivity Solution, (6) 2.5ml Ampules Bitrex™ Test Solution, (2) spare parts for nebulisers & Moldex Qualitative Fit Test CD

Stock No.	Description	Price
010200	Bitrex Qualitative Fit Test Kit	\$329.84
050400	Bitrex Fit Test Solution 2.5ML.....	20.45



#010200

HydroCycler Filter Press Water Recycling

The HydroCycler uses filter press technology that is industry proven and reliable. The system compacts the sludge into easy to dispose of cakes and provides very clean water suitable for all demands in stone fabrication.

- 100% closed loop, zero discharge recycling system
- Reduced water usage/reduced water costs
- Creates dry cakes for immediate disposal to land fill
- Flow rates of 6gpm to 200gpm

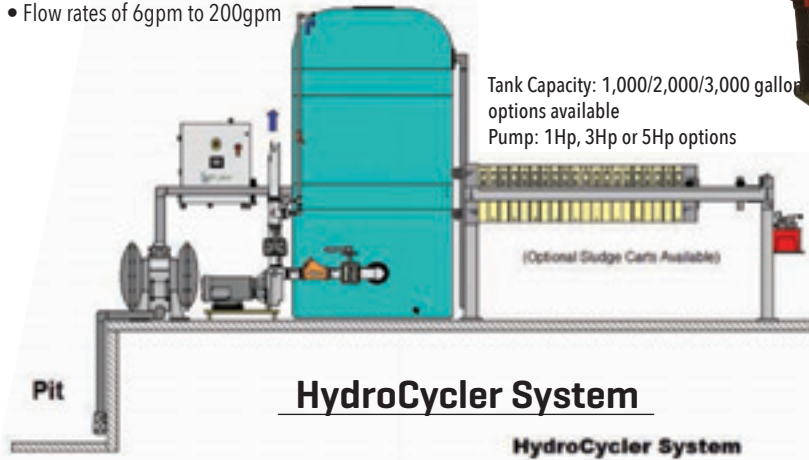

Gasketed Filter Cloth

Stock No.	Description	Price
912016	Intermediate, 470mm	CALL
912017	End, 470mm.....	CALL
114529	Intermediate, 630mm	CALL
114531	End, 630mm.....	CALL
114530	Intermediate, 800mm	CALL
114534	End, 800mm.....	CALL

Filter Cloth Precoat Compound

Harborlite 700 is a lighter perlite precoat with high permeability for better system flow. The industry standard for more than a decade.

Stock No.	Description	Price
900103	Harborlite 700/30 lb.....	\$32.50

Dicalite 416 is a filter cloth precoat that provides the added protection needed in engineered stone applications.

Stock No.	Description	Price
900111	Dicalite 416/40 lb.....	\$27.95



GelMaxx Slurry Products

GelMaxx slurry products have a unique formula using organic materials making them safer for the environment and operators, while maintaining EPA compliance.

GelMaxx ECO-QUICK gel solidifies & absorbs slurry into a dry material and can be disposed immediately in any standard trash container.

GelMaxx AQUAmaxx separator reduces the amount of slurry while producing reusable water for machinery.

Stock No.	Description	Price
113466	35 lb. Bucket Eco-Quick Gel	\$180.00
113467	50 lb. Box Eco-Quick Gel	250.00



GelMaxx AQUAmaxx is a proprietary blend with special additives that will separate suspended solids from processed slurry water. AquaMaxx separates the solids within minutes, and can handle light, medium, and heavy stone & concrete slurry. This powerful material will reduce the amount of slurry waste by removing the usable water which can be reused back into machinery.



Stock No.	Description	Price
113468	1 Gal. Bucket AquaMaxx	\$50.00
113469	5 Gal. Bucket AquaMaxx.....	150.00

Amount of Slurry	Eco-Quickgel Required
1 Gallon	20 Grams
5 Gallons	100 Grams
55 Gallons	2.5 lbs.
110 Gallons	5 lbs.
300 Gallons	14 lbs.
500 Gallons	23 lbs.
770 Gallons	35 lbs.
1,100 Gallons	50 lbs.

Simplifies cleanup of dust and debris.



Qty. of AQUAMAXX	Per. Qty. of Slurry Water
2-3 tbsp.	1 gallon
2-3 quarts	55 gallons

5 Gallons of AquaMaxx can separate approximately 450 gallons of slurry water.

PRISTINE WATER RECYCLING SYSTEMS

GranQuartz helps you save on your water bill!

Solutions to remove suspended solids from stone fabrication water waste streams using one of two methods - Settling or Filtration

Recycling water in the stone fabrication industry is now common place and increased enforcement of pollution control regulations along with rising costs of water and sewer have made it imperative that stone fabricators look to water recycling. Water recycling provides you with a solution for regulatory concerns and saves on your monthly water costs as well, with typical savings of up to 90%.

All GranQuartz® water systems are made in the USA. Components are rugged and durable for long life and strong performance. Two primary systems are offered; the HydroSettler and the HydroCycler, in multiple sizes and configurations.

HydroSettler

Utilizing rapid settling technology from industrial wastewater treatment the HydroSettler removes over 95% of the solids from the slurry water stream in real time with very little maintenance.

- 40gpm to 100gpm gray water system
- 100% closed loop, zero discharge system
- Easy maintenance and operation
- High solids removal
- High quality gray water

HydroCycler

Filter Press Water Recycling

The HydroCycler uses filter press technology that is industry proven and reliable. The system compacts the sludge into easy to dispose of cakes and provides very clean water suitable for all demands in stone fabrication.

- 100% closed loop, zero discharge recycling system
- Reduced water usage/reduced water costs
- Creates dry cakes for immediate disposal to land fill
- Flow rates of 6gpm to 200gpm

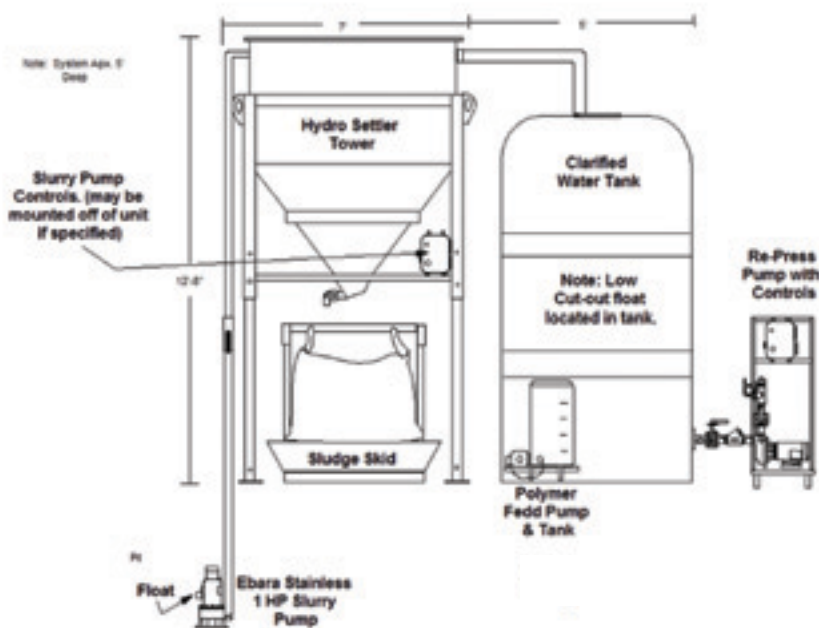

Hydro Settler System

**Call Now for
System
Consultation
and Price
Estimates.**

SASSO Flying Flat Vertical Edge Polisher Quality Edge Options From a Compact Machine

SASSOAMERICA's Flying Flat features a patented design providing high volume, high quality edging productivity. A waterproof, multi-control keyboard coupled with new ergonomic coverings protect the machine from rust and corrosion, extending the machine life. The multifunction spindle is able to do water-drip, calibration and edge beveling. Mechanical parts are readily accessible via large, pneumatic opening doors. A fully guided belt helps to maintain stability during vertical work.

- 5 Fully-encapsulated polishing spindles equipped with micro oscillation
- 1 Fixed-position front spindle provides stock removal of .5mm per minute
- 2 Bevel/chamfer spindles
- Belt speed indicator
- Anti-corrosion protective shell



#102007
\$57,999.00



Adjustable belt speed is achieved using speed settings and inverter for functionality.



Horizontally positioned control panel for ease of operation and faster processing time.



Spindles are equipped with independent motors and encapsulated, waterproof bearings.



Easily opened pneumatic doors for access during maintenance procedures.

Slab Specifications:

- Minimum Thickness: 0.787"
- Maximum Thickness: 2.36"
- Maximum Radius: 1.97"

Equipment Specifications:

- Maximum Power: 15.5 HP
- Weight: 4,400 lbs. (approx.)
- Tape Advancing Speed: 1.31' - 6.56'/minute
- Air: 90 PSI at 3-5 CFM
- Water: 15-25 Gallons Per Minute
- Electric: 3 Phase Power Required (208v/220v/240v)
- Dimensions: 4.92' H x 7.87' W x 3.94' D

ELaser Xpress 2D/3D

The ELaser Xpress series delivers a more economical solution for many digital templating and measuring needs. ELaser Xpress 2D measures any 2D surface as well as freeform curves. Use the quick settings feature to predefine specifications for overhangs, corner radii, backslashes, and more to automate countertop design, reducing editing and increasing efficiency. Easy to use icons identify tools to measure points, lines, arcs, circles, rectangles, splines, and polylines for custom measuring. Import and export DXF, DWG, IGES, and more for engineering and fabrication. Advanced best-fit algorithms improve accuracy and installation fit. Xpress 3D includes all 2D functionality and a complete 3D measuring and modeling system for as built construction. Integrate with popular industry leading software such as Cabinet Vision, 2020, KCD, Mozaik, & ProKitchen to complete your design.

- Countertop Templating/Full Height Backsplash
- Shower Enclosures/Tub Surrounds/Fireplaces
- Wall Cladding, Stair Treads
- Cabinet Layout and Design (Xpress 3D Only)
- 3D Modeling/BIM (Xpress 3D Only)
- Indoor/Outdoor
- Quality Control/Construction Verification
- 1mm Accuracy, Fast Setup, Easy-To-Use
- Installs On User Provided Windows 10 Laptop
- User Manual and Video Library Included



Use Your Windows 10 Laptop

Recommended Computer Specifications for ELaser Systems:

- Laptop Computer
- 1920x1080 Max Resolution Screen, Keyboard w/touchpad.
- Windows 10 Pro or Home
- Core i3 (7th Gen or Newer) processor
- 4GB DDR4 RAM
- SSD (Solid State Drive)
- 2 USB Ports Minimum
- 8-10 Hours Battery Life



System Includes: Laser Head, Tripod, Cradle, Countertop Markers, 4 Rechargeable Batteries and Charger, Rugged Carry Case, Measure Manager(MM) Software, System User Manual, 3 Year Warranty & MM Software Updates(Registration Required), Training, and Lifetime Technical Support.

Stock No.	Description	Price
981810	ELaser Xpress 2D Laser	\$8,995.00
981811	ELaser Xpress 3D Laser	9,995.00
981812	ELaser Xpress Laptop Tray	295.00
981814	ELaser Xpress Software Upgrade	1,000.00
981816	ELaser Additional CAD License	1,500.00
981817	ELaser Server CAD License	2,250.00

FARNESE MARC5 CNC BRIDGE SAW



Farnese® MARC5 5-Axis CNC Bridge Saw

The MARC5 is the new breed of 5 axis bridge saws for the stone industry. It has a full CNC controller which coupled with the very easy to use front end program, makes this machine one of the most versatile saws available in the market. The head/blade mechanism rotates a full 360° allowing the operator to make angled and circular cuts as well as tilting from 90° to 0° for drop in sink work.

The MARC5's CNC programming allows the operator to use the machine in four different modes: manual, parametric, semi auto and full auto. In manual mode, the operator, apart from the normal functions, can operate the machine to cut at any angle across the table in any direction. In full automatic modes, will make cut

in any direction, as well as curves and circles. DXF files can be imported and programmed making the machine compatible with most digital templating machines out in the market. The spindle has a 1/2" GAS attachment that allows to fit a drill, this feature can be programmed to drill out the corners of internal cut outs for easy removal of the internal piece.

The machine is also fitted with a tilting table that can be operated from the front panel. The Monolithic Design is a great space saver in today's shop with no compromise in the "Full Slab Cutting" sizes.

\$91,799 Installation: #931136.. \$4,500.00
#931158

Dimensions of Installed Machine

WIDTH	5,850 mm/230.3 in
DEPTH	4,300 mm/169.3 in
HEIGHT	2,600 mm/102.4 in
WEIGHT	3,000 kg/6,600.0 lb

Table Dimensions

WIDTH	3,700 mm/145.7 in
DEPTH	2,000 mm/78.7 in
HEIGHT	660 mm/26.0 in
ROTATION	NO
TILT	YES

Features & Feed Specifications

CUTTING LENGTH (LONG TRAVEL STROKE)	2,300 mm/90.6 in
CUTTING WIDTH (CROSS TRAVEL STROKE)	3,600 mm/141.7 in
CUTTING HEIGHT (HEAD UP AND DOWN)	300 mm/11.8 in
BLADE DIAMETER (MAX)	550 mm/22 in
BLADE SHAFT DIAMETER	60 mm/2.36 in
BLADE TILT	90 - 0°
HEAD ROTATION	0-360°
DRILLING CAPABILITY	YES G1/2 in
LASER CUTTING GUIDE	YES
THICKNESS PROBE	YES
MS WINDOWS AND DXF CAD COMPATIBLE	YES
AUTOMATIC GREASING	YES
MAIN SPINDLE POWER	11 KW/20 HP
MAIN SPINDLE SPEED	1,440 RPM/2,000 RPM
POWER REQUIREMENT	50AMP, 208 V, 3-PHASE

FARNESE LYNX PLUS BRIDGE SAW



Farnese® Lynx Plus 20 HP Bridge Saw

The Farnese LYNX Plus Bridge Saw is an upgraded entry level bridge saw with user-friendly controls and a compact design packed with high quality features.

- 20 HP Direct Drive Motor
- Wireless Remote Pendant
- Pneumatic Table Lock
- Programmable automatic repeat cuts
- Pneumatic 45° tilting head with plunge cut capabilities
- Hydraulic tilting table for easy loading.
- Laser is mounted to the saw head rather than the bridge.
Projects accurate cut line in both 90° & 45° positions.
- AC servo motors for smooth precision movements.
- Central lubrication for easy maintenance.
- Faster cutting modes available in manual mode and semiautomatic mode.

Installation: #931135.. \$4,000.00

\$54,750

#931150

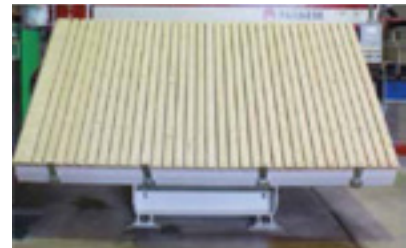

ALEXIA GEN2 UNDERMOUNT SYSTEM

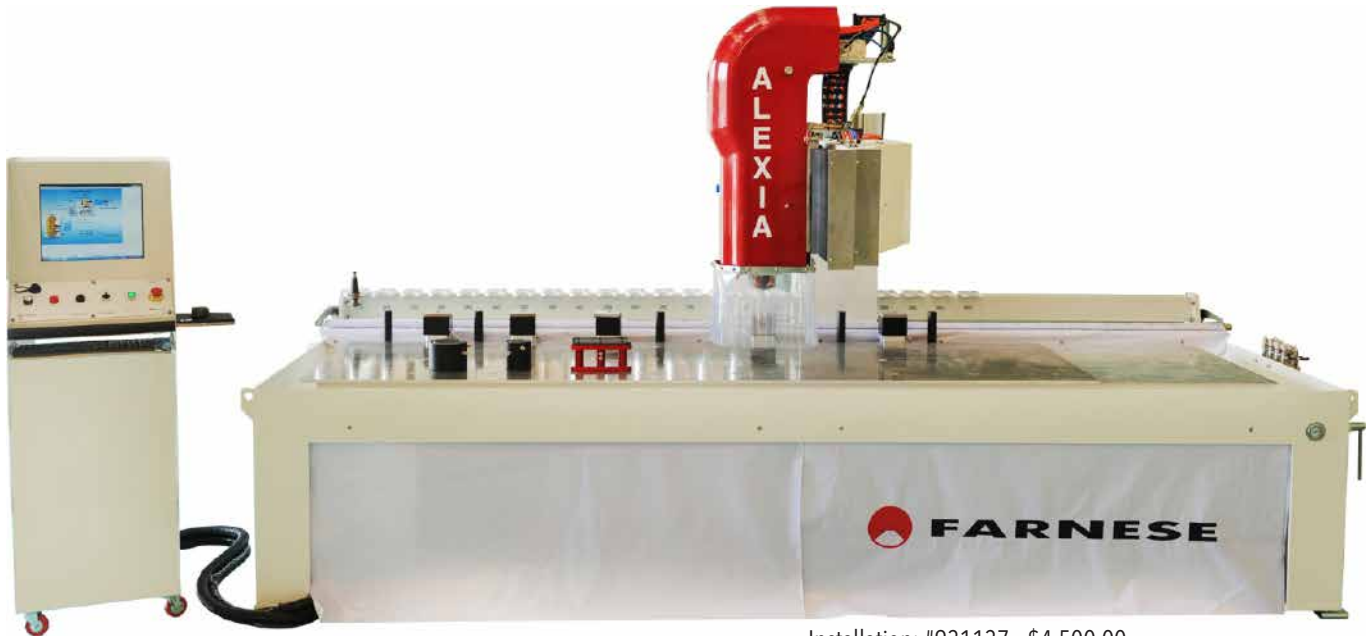

Installation: #931137.. \$4,500.00

\$95,899

#931133

Farnese® ALEXIA GEN2 Automated Sink Cutout Machine

The ALEXIA GEN2 automates the cutting, drilling and polishing of sink cutouts and is the ultimate solution to affordable stone processing without compromising on quality. The machine has automatic tool changing with 23 stations.

An excellent feature of the ALEXIA is its user-friendly interface, the Software has been designed for MS Windows and is intuitive and simple to use. It is pre-loaded with common sink templates listed by brands including Oliveri, Franke, Clark and Blanco. Many other sinks sizes and shapes can be easily created using the parametric section extending the machine's cutting capabilities.

Dimensions of Installed Machine

WIDTH	4,200 mm/165.4 in
DEPTH	2,200 mm/86.6 in
HEIGHT	2,300 mm/90.6 in
WEIGHT	2,500 kg/5,500.0 lb
MAX Slab Dimensions	
WIDTH	4,000 mm/157.5 in
DEPTH	1,700 mm/66.9 in

Features & Feed Specifications

CUTTING WIDTH (LONG TRAVEL STROKE)	3,000 mm/118.1 in
CUTTING DEPTH (CROSS TRAVEL STROKE)	1,100 mm/43.3 in
CUTTING HEIGHT (HEAD UP AND DOWN)	200 mm/7.9 in
AIR PRESSURE (WORKING)	7 BAR/102 PSI
AIR PRESSURE (CONSUMPTION)	350 LITERS/MIN
WATER CONSUMPTION (CLEAR)	6.5 LITERS/MIN
WATER CONSUMPTION (RECYCLED)	50 LITERS/MIN
MAGAZINE	YES, 23 POS
VACUUM CUPS	YES
VACUUM GENERATOR	YES
BACK CLAMPS	YES
FRONT CLAMPS	NO
LASER CUTTING GUIDE	YES
AUTOMATIC TOOL CHANGER	YES
MS WINDOWS COMPATIBLE	YES
AUTOMATIC GREASING	YES
HAND WHEEL	YES
MAIN SPINDLE POWER	6.6 KW/8.8 HP
MAIN SPINDLE SPEED	500 RPM/12,000 RPM
POWER REQUIREMENT	20AMP, 400V, 3-PHASE



NEW!

\$19,900
#446395

Fab King® Sink Cutout Machine

Cut out any sink shape using a template in as little as 8 minutes and drill utility holes in seconds with minimal tool wear. Edge profiling is quick and easy with no threat of scratching the surface. Other features of the Fab King include surface polishing and honing, and back-splash polishing.

- Motor: 3hp, variable speed 2,700-10,000 rpm
- Electrical: 220 volt single phase

- Water consumption: 3 gallons per minute
- Travel: 114" L, 30" W, 8" H
- Connection: 1/2 gas, water fed
- Movement: precision control raise/lower with friction brake
- Working Area: 3-point adjustable work surface
- Dimensions: 11' 9" L x 5' 11" H x 3' 8" W



Recon® Incremental Finger Bit

For use on sink cut-out machines.

- 20 x 23mm
- Max RPM: 4,000-9,000
- M12 connection

Stock No.	Description	Price
100750	20mm x 23mm, M12	\$75.90



Mandrels for Grinding Tips

Stock No.	Description	Price
100847	Fingerbit Adapter 1/2 Gas-M12,31mm	\$107.85
100849	Fingerbit Adapter 1/2 Gas-M12,49mm	95.95
100848	Replacement Sleeve, 49mm	25.80
116327	For Thibaut 1/2 Gas thread	74.60



Farnese® Miter Saw VS

Make clean, quick and accurate miters with Farnese's MITRE SAW VS!

Simply and quickly cuts accurate miters on a wide range of materials including engineered stone, granite, marble and porcelain of thickness ranging from 8 to 40mm.



Installation: #931134.. \$2,250.00
\$26,999
#931157

Dimensions of Installed Machine

WIDTH	4,800 mm/189.0 in
DEPTH	1,200 mm/47.2 in
HEIGHT	1,100 mm/43.3 in
WEIGHT	1,000 kg/2,200.0 lb
Roller Table Dimensions	
WIDTH	1,600 mm/63 in
DEPTH	600 mm/23.6 in
HEIGHT	800 mm/31.5 in

Features & Feed Specifications

CUTTING LENGTH (LONG TRAVEL STROKE)	3,250 mm/128.0 in
TABLE LENGTH	3400 mm/133.9 in
TABLE WIDTH	600 mm/23.6 in
BLADE DIAMETER	3,250 mm/128.0 in
BLADE ANGLE	45° ± 1
BLADE IN/OUT MOVEMENT	50 mm/2.0 in
CUTTING SPEED	0-8mm/MIN (0=315 in/MIN)
MANUAL GREASING	YES
MAIN SPINDLE POWER	4.0 KW/5.4 HP
MAIN SPINDLE SPEED	1,440 RPM
VARIABLE SPINDLE RPM	STANDARD
POWER REQUIREMENT	21AMP, 208V, 3-PHASE

FARNESE EZ SINK CNC CUTOUT MACHINE



Installation: #931163.. \$4,000.00

\$72,750
#931162

Farnese® EasySink Cutout System

Create sink cutouts both cut and polished with ease using the EASYSINK, this compact CNC machine was designed to simplify the task of doing sink cutouts at an affordable price.

The EASYSINK comes with a user-friendly touch screen interface to machine sink cutouts parametrically. This EASYSINK allows you to machine simple shapes (square, circles, ovals) changing dimensions and the radius for corners with common sink templates. Sink cutouts can be processed within the front and rear pneumatic clamps up to 1200 by 600mm on slabs over 3 metres long by 700mm. An optional laser indicator can help precise aiming of the cutout and the machine is also equipped with a manual tool changer and lubrication pump. The EZ Sink has a small footprint, saving valuable space in your shop.

Dimensions of Installed Machine

WIDTH	2,800 mm/110.2 in
DEPTH	1,900 mm/74.8 in
HEIGHT	2,100 mm/82.7 in
WEIGHT	1,500 kg/3,300.0 lb

Max Size of Slab

WIDTH	3,200 mm/126.0 in
DEPTH	1200 mm/47.2 in

Features & Feed Specifications

CUTTING WIDTH (LONG TRAVEL STROKE)	1,200 mm/47.2 in
CUTTING DEPTH (CROSS TRAVEL STROKE)	600 mm/23.6 in
CUTTING WEIGHT (X/Y HEAD TRAVEL)	170 mm/6.7 in
AIR PRESSURE (WORKING)	6 BAR/87 PSI
AIR PRESSURE (CONSUMPTION)	20 LITERS/MIN
WATER CONSUMPTION (CLEAR)	0 LITERS/MIN
WATER CONSUMPTION (RECYCLED)	30 LITERS/MIN
BACK CLAMPS	YES
FRONT CLAMPS	YES
AUTOMATIC GREASING	YES
LASER CUTTING GUIDE	YES
MAIN SPINDLE POWER	4.0 KW/5.4 HP
MAIN SPINDLE SPEED MIN-MAX	500-6,000 RPM
VARIABLE SPINDLE RPM	STANDARD
POWER REQUIREMENT	20AMP, 400V, 3-PHASE





Installation: #931161.. \$5,500.00
\$118,999

#931159

Farnese® Technicut CNC Bridge Saw

The TECHNICUT CNC Saw is a full 5 axis CNC controlled saw fitted with side vacuum manipulators for ease of movement of the material with thickness measuring probe. Even though it is a full CNC controlled 5 axis machine, the operator can still use the machine manually as if it was a simple standard bridge saw. The machine is fitted with a separate pendant station that allows the operator movement in order to use the machine for quick manual cuts. It can also work in a Semi-Automatic Program in which the operator can quickly and easily program all the cuts in the X and Y axis allowing for quick trimming and rectangle production. The CAD/CAM system supplied with the machine allows any 2D shapes to be produced including vacuum moves. You can also perform simple or complicated cuts using the vacuum manipulator whenever you have blind or curved cuts. The spindle has a 1/2" GAS attachment that allows to fit a drill. This feature can be programmed to drill out the corners of internal cut outs for easy removal of the internal piece. Internet connectivity makes it is possible to log into the machine remotely from our office to help trouble shoot any issue provide further online training.



Farnese® Studio Block Saw

Farnese's STUDIO saw is great for sandstone fabrication accommodates a cutting blades up to 1000mm in diameter which enables a work place of up to 370mm to be cut. A standard table for heavy sandstone and monument work. The paint is a two pack undercoat, with a splatter finish top coat and color final coat, making it resistant to corrosion and scratches.

Dimensions of Installed Machine	
WIDTH	5,800 mm/228.3 in
DEPTH	5,800 mm/228.3 in
HEIGHT	3,500 mm/137.8 in
WEIGHT	4,000 kg/8,800.0 lb
Table Dimensions	
WIDTH	1,800 mm/70.9 in
DEPTH	3,200 mm/126.0 in
HEIGHT	750 mm/29.5 in
ROTATION	YES
TILT	OPTIONAL

Features & Feed Specifications	
CUTTING L (LONG TRAVEL STROKE)	3,600 mm/141.7 in
CUTTING W (CROSS TRAVEL STROKE)	3,400 mm/133.9 in
CUTTING WEIGHT (X/Y HEAD TRAVEL)	600 mm/23.6 in
MAX BLADE DIAMETER	1,000 mm/39 in
BLADE SHAFT DIAMETER	60 mm/2.36 in
BLADE TILT	0-45°
LASER CUTTING GUIDE	YES
MAIN SPINDLE POWER	14.6 KW/20 HP
MAIN SPINDLE SPEED	960 RPM
VARIABLE SPINDLE RPM	STANDARD
POWER REQUIREMENT	40AMP, 440V, 3-PHASE

Installation: #931165... \$4200.00
\$63,599
 #931164

PORCELAIN

Porcelain is taking the fabrication industry by storm and we understand why. It has a reputation for being one of the most durable, hygienic, attractive and easily maintained surface choices available for the modern home, with a wealth of color and texture options. In anticipation of this, we present a small selection of our tooling & equipment chosen specifically for the fabrication and installation of porcelain and other lighter surface materials.

Manzelli® EXE 16PN GRES Thin Material Power Tilt Vacuum lifters

Manzelli's EXE 16PN GRES lifter is specifically designed for lifting porcelain and thin slabs. It is powered by compressed air with an aluminum ejector and nylon silencer, with an operating pressure (for vacuum creation) of 6 bar.

- Air consumption: 120L/Min.
- Manual or pneumatic tilt from 0° to 90°
- Weight capacity: 793.664 Lbs. (360 Kg)
- Electronic self-governing lighted/acoustic alarm system, complete with battery charger



NEW!

Omni Cubed® S3 - Slim Slab Saver™ Porcelain Frame

Omni Cubed S3 frames are customizable rigid frame and reinforcement system for handling large format porcelain slabs and other fragile materials. S3 frames are an ideal solution for transport and installation of LFTMTM (large format thin material), gauged or thin porcelain slabs such as Laminam®, and sintered material such as Neolith® or Dekton®. Non-marking 6" vacuum cups feature an ultra-concave design for fast attachment to bowed or leathered surfaces, and have a flexible triple seal for a secure, reliable hold. Cups, clamps, and rails can be arranged in any configuration for a variety of applications and easy-grasp knobs enable quick repositioning of every component in this system. Each clamp has an integrated "resting foot" that won't scratch finished surfaces or flooring when material is inverted. Adjustable leveling legs with resting feet are incorporated into handles to allow upright resting and leveling of the material. Kickstand (available option) provide hands-free support for applying mortar or adhesive. Durable, UV-resistant foam grips provide a comfortable handle for safe transport.

- Powerful yet compact pump that has a built-in rechargeable battery providing vacuum pressure for up to 5 continuous hours on a single charge
- Spring-loaded mounting pins hold the pump flush with the rail so it doesn't interfere with vacuum cup placement
- Rails extend from 61"-112" (155-284 cm) to accommodate material up to 118" (300 cm) in length
- Each vacuum cup accommodates up to 70 lb (31 kg); each rail can handle up to 200 lb (90 kg)

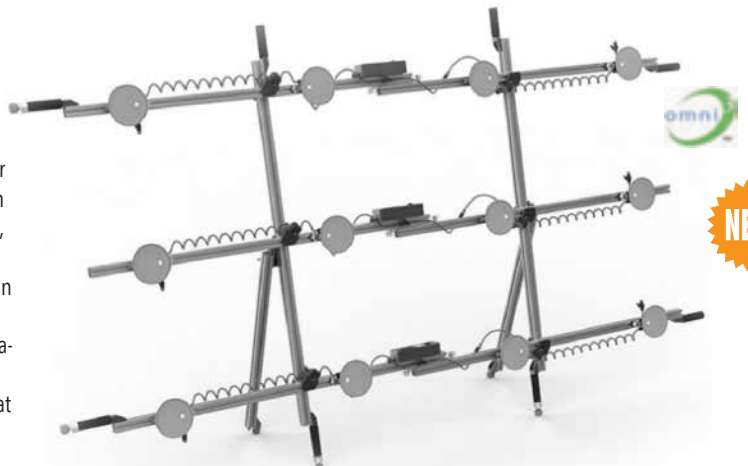

NEW!

Stock No.	Model	Price
350323	S3, 1-Rail Automatic.....	\$1,095.00
350324	S3, 1-Rail Manual.....	645.00
350325	S3, 2-Rail Automatic.....	2,895.00
350326	S3, 2-Rail Manual.....	1,995.00
350327	S3, 3-Rail Automatic.....	4,745.00
350328	S3, 3-Rail Manual.....	3,395.00
350329	6" Cup Mount Assembly	95.00
350330	Extension Slide Bracket.....	65.00
350331	Horizontal Handle w/Leg Leveling Kit	150.00
350332	Kickstand Kit for S3 Frames.....	395.00
350333	Rigid Cross-Brace (Fits All Sink Hole Savers) ...	850.00
350334	Rigid Cross-Brace, 2-Clamp Kit.....	250.00
350335	Omni Cubed Vac. Pump Motor, VMP750.....	450.00

Blue Ripper Miter Master Rail Saw for Porcelain

Light-duty (28 Lb.) version of the Blue Ripper Miter Master for cutting porcelain, large format tile and other thin materials. Uses 2 grinders to simultaneously cut BOTH matched 45° angles. Rails available separately, fits all Blue Ripper Rails.

- One hand water disconnect with 10' water hose
- GFCI protection
- Weight: 28 Lbs.



NEW!

Abaco® Porcelain Lifters

Designed to lift and move porcelain and other materials which are flat, long, thin, delicate, and breakable. Clamping mechanism is fully automatic and the large surface contact area for the material is covered by rubber pads to prevent damage to materials when lifting. Two guide shafts lead the lifter into position and four lower wheels allow for easy maneuvering when not in use, with four upper wheels providing pressure and acting as a guide to center slab within the two clamps.

- Made of strong, lightweight aluminum



NEW!

Stock No.	Model	weight/lbs.	load/lbs.	Price
448625	APL20-W ...	50.6	660	\$1,085.00

Stock No.	Description	Price
699209	Blue Ripper for Porcelain (No Rails).....	\$2,449.05
692671	148" Rail for Blue Ripper	610.00
692670	92" Rail for Blue Ripper	360.00

Raimondi® Easy-Move Transport System

4th Generation Easy-Move Frame system is perfect for handling large format tile/porcelain surfaces. Weight has been reduced and the frame is now equipped with RV175 vacuum cups made using stain free, light colored rubber with die-cast aluminum bodies and are great for handling textured surfaces. 4 Sliding rubber gripped handles provided w/non-slip, stain proof grommets for excellent ergonomic function even when performing vertical installations.

- Perfect for handling large format porcelain/tile surfaces
- Vacuum cups can be adjusted into any position along rails
- Crossbars can easily be tilted at angles to adapt to any slab layout
- Max. slab length: 10½', Min. slab length: 3.3'



NEW!

Stock No.	Description/Weight	Price
*276637	Easy-Move Full Frame, 2 Bars, 2 Crossbars, 8 Cups, 63½ Lbs	\$2,350.00
*276638	Easy-Move, 6 Cups, 44.7 Lbs	1,700.00

Raimondi® Easy-Move Cart

Specially designed for the transport and handling of large format tiles (10.5' x 5.25' x 15/32"). The Raimondi Easy-Move Cart allows you to easily and safely spread adhesive on the back of the tile while loaded on cart. It comes with two height-adjustable hooks for holding the cart while slab is loaded and ready access to the suction cups while used with the Easy-Move frame on the cart allows you to restore suction easily if needed, which is particularly important when installing textured large format tiles.

- One side of cart can be used to transport slabs short distances
- 2 height-adjustable rubber supports (storage side) prevent damage to material (slabs)
- Telescopic, fully-adjustable safety hooks prevent slabs from falling
- Wooden platforms with rubber edges on both sides of the cart
- Two of the four pivoting wheels lock in place
- Vacuum cups can be adjusted into any position along rails
- Strong, lightweight aluminum components
- Max. load: 551 Lbs.



NEW!

Stock No.	Description/Weight	Price
*276639	Easy-Move Cart for Use with Full Frame....	\$970.00

Raimondi® Work Bench Plus

The Raimondi Work Bench with adjustable width (3' 3" to 5') supports wider material when required. Join two Work Benches together for a work surface long enough for any size large format slab.

- 5'9" L x 3'3"- 5' W (adjustable width)
- Extends to 5' in width
- Double-folding Legs fold in directly under table surface
- Adjustable feet for perfect leveling
- Extremely sturdy and stable work area

Stock No.	Description	Price
*276635	Work Bench Plus.....	\$980.00



NEW!

Raimondi® Raizor Score & Snap Cutter

The Raimondi Raizor is a cutting and scoring rail system for porcelain and other large format material which utilizes a die-cast cutting unit with three (3) polyoxymethylene carbide wheels.

- Lightweight (20 lbs.) and easy to use
- Two (2) internal bearings per wheel for fine adjustment & precise cutting
- Rails are equipped with three (3) stain-free 3½" suction cups
- Includes two (2) rails, each 5½' L which connect together to a full 11' rail

Stock No.	Description	Price
*276636	Raizor Score & Snap Cutter	\$820.00

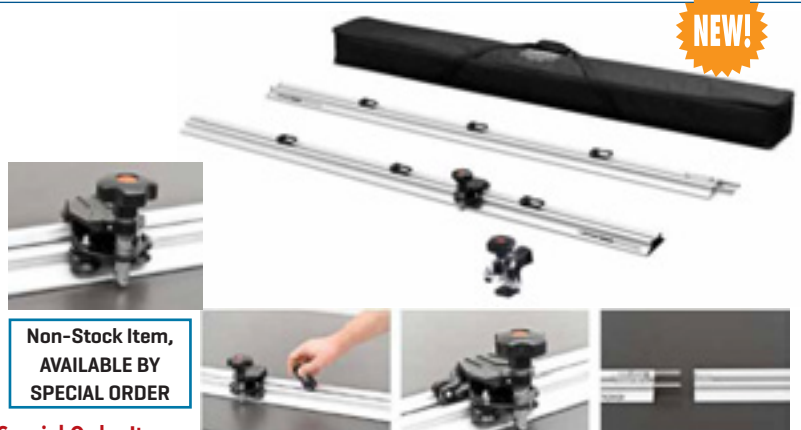

NEW!

Non-Stock Item,
AVAILABLE BY
SPECIAL ORDER

*Indicates Special Order Item

Alpha® EZ Thin Cutter Starter Kit

Kit includes everything to begin cutting thin materials.

- 24" EZ Thin Panel T-Cutter
- Alpha Slimline Cutter
- EZ Glass Running Pliers
- EZ Cutter Oil, 8 Oz. Bottle

Stock No.	Description	Price
*700429	Alpha EZ Thin Cutter Starter Kit	\$268.30



Alpha® EZ Thin Panel T-Cutters

Designed for cutting porcelain tile using score & snap method. Use on all tile and thin panel materials.

- Convenient and easy to use
- Clean breaks every time
- T-Cutter designed for fast, precision cutting
- Available in 24" or 60" length
- Special order product

Stock No.	Description	Price
*700425	Alpha EZ Thin Panel T-Cutter, 24"	\$170.45
*700426	Alpha EZ Thin Panel T-Cutter, 60"	253.30



Alpha® Slimline Oil Cutter

Designed to score and snap new thin materials, such as SlimLite™ from Daltile®, Laminam® from Crossville® and more. The tile or panel can be scored with a ruler then snapped manually or cut with EZ T-Cutter for an accurate and fast cutting application on smooth, un-textured surfaces only.

- Designed for cutting by score & snap method
- Great on tile and thin panels
- Clean, consistent breaks
- T-Cutter designed for fast, precision cutting
- Low maintenance and long service life

Stock No.	Description	Price
70042	Alpha Slimline Oil Cutter	\$27.50



Alpha® EZ Thin Tile Cutters

Designed to score and snap new thin materials, such as SlimLite™ from Daltile®, Laminam® from Crossville® and more. The tile or panel can be scored with a ruler then snapped manually or cut with EZ T-Cutter for an accurate and fast cutting application on smooth, un-textured surfaces only.

- Designed for cutting by score & snap method
- Great on tile and thin panels
- Clean, consistent breaks
- T-Cutter designed for fast, precision cutting
- Low maintenance and long service life



Stock No.	Description	Price
*700428	Alpha EZ Glass Running Pliers	\$73.62

*Indicates Special Order Item

TUSCAN® SeamClip™ System

Tuscan SeamClips are the latest innovation for lippage free tile installation on walls & floors. SeamClips are 1-piece spacers that are easy to use with no tools required!

- Easy to use
- No tools needed
- Eliminates lippage
- For vertical or horizontal installations

Stock No.	Description	Price
677710	150 SeamClips, Red	\$44.62
677711	500 SeamClips, Red	140.66
677712	1000 SeamClips, Red	279.12
677713	150 SeamClips, White	44.62
677714	500 SeamClips, White	140.66
677715	1000 SeamClips, White	279.12
677716	150 SeamClips, Blue	44.62
677717	500 SeamClips, Blue	140.66
677718	1000 SeamClips, Blue	279.12



Blue SeamClip- for 1/4" to 1/4" thick ceramic tile



Red SeamClip- for gauged tile 3/8"-1/2" thick



White SeamClip- for 1/8" thick large format thin-body ceramic tile & gauged tile up to 1/4" thick



NO TOOLS NEEDED!



FAST, EASY REMOVAL!

ADI® Continuous Rim Porcelain Blade

Highest quality Italian designed and manufactured diamond blade for cutting all porcelain surfaces. Ensures clean, fast and consistent cutting.

- 10mm Rim height
- Specially designed for cutting porcelain
- Ultra clean cutting



Stock No.	Diameter/Arbor	Price
926976	14", 60mm	\$255.00
926977	16", 60mm	299.00

König® UCS Speed Porcelain Blade

German engineered blade designed specifically for cutting porcelain and ultra compact surfaces. Reinforced steel core is great for making miter cuts.

- 10mm Rim height
- Designed for cutting porcelain and UCS
- Ultra clean, very fast cutting

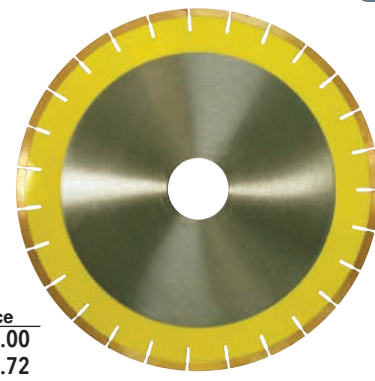

Stock No.	Diameter/Arbor	Price
057384	14", 60mm	\$345.00
057385	16", 60mm	377.72
057386	18", 60mm	415.00

Pearl® P5™ Continuous Rim Porcelain Blade

The P5 blade has a high diamond concentration continuous rim for extra long life and the provides clean and chip-free cutting of porcelain surfaces.

- 9mm Rim height
- Clean and chip-free cutting
- High diamond concentration



Stock No.	Diameter/Arbor	Price
990176	4", 60mm	\$35.50
695217	7", 60mm	51.40
695219	8", 60mm	71.35
695224	10", 60mm	94.45

Pearl® P4™ Thin Mesh Turbo Blade

The P4 turbo blade has a special turbo-mesh rim design and thin core for faster, cooler cutting with minimal chipping.

- Long blade life
- Cuts cool
- Increased blade life

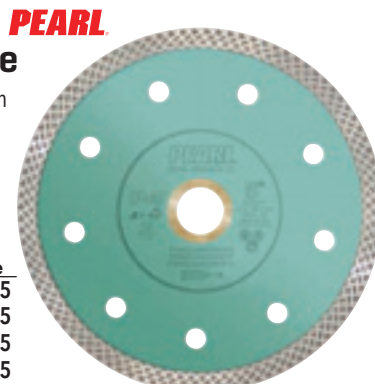

Stock No.	Diameter/Arbor	Price
920665	6", 5/8 - 20mm - 7/8, QUAD.	\$48.95
920672	4", 5/8 - 20mm - 7/8	28.55
920673	4 1/2", 5/8 - 20mm - 7/8	32.45
920674	5", 5/8 - 20mm - 7/8, QUAD	36.25
920675	7", 5/8 - DKO - 7/8	54.95
920676	10", 5/8 - 20mm - 7/8	65.95
920677	14", 50/60mm - 7/8	149.95

Diarex® Continuous Rim Porcelain/Glass Blade

Designed using Pattern Diamond Segment technology and is an excellent choice for cutting granite, glass tile, porcelain and quartzite.

- 9mm Rim height
- Clean and chip-free cutting
- Pattern Diamond Segment technology



Stock No.	Diameter/Arbor	Price
993781	14", 50/60mm	\$199.90
993782	16", 50/60mm	239.95

Cyclone® Ultra UCS/Porcelain Blade

Cyclone's Ultra UCS/Porcelain blade is an extremely versatile blade, great for cutting Ultra Compact Surfaces and Porcelain.

- Long blade life
- Proprietary segment design
- Clean and fast cutting



Stock No.	Diameter/Arbor	Price
052570	14", 60mm	\$189.95
052571	16", 60mm	240.00



Black Magic® Diamond-Resin Cup Wheels

For true chip-free beveling of ceramic, porcelain & other natural stone surfaces.

- 5/8"-11 female thread
- Aluminum backed

Stock No.	Description	Price
637514	4", 100 Grit	\$39.95
637515	4", 200 Grit	39.95



Black Magic® D-Fiber Cup Wheels

Low vibration reduces chipping and proprietary "tread" pattern provides the perfect amount of aggressiveness.

- 5/8"-11 female thread

Stock No.	Description	Price
800708	4", FINE	\$89.95
800709	4", MEDIUM	89.95
800710	4", COARSE	89.95



Pro Series® Vacuum Brazed Core Bits

Designed with two vacuum brazed pads on the inside of the body and long cooling slots for efficient and easy core removal.

Stock No.	Diam.	Price
993578	9/16"	\$64.95
993579	3/4"	68.95
993580	1"	69.95
993581	1 1/8"	72.95
993582	1 1/4"	75.95
993583	1 3/8"	78.95
993584	1 1/2"	79.95
993585	1 3/4"	84.95
993586	2"	89.95



Pro Series® Non-Coring Vacuum Brazed Bits

For fast, clean drilling of ceramic, porcelain, marble and most other natural stone surfaces

- 5/8"-11 female thread
- Wet or dry use

Stock No.	Diameter	Price
993573	3/16"	\$56.95
993574	1/4"	57.95
993575	5/16"	58.95
993576	3/8"	59.95
993577	1/2"	62.95

WORK STATION CRANES

Granquartz offers a complete line of GORBEL overhead crane systems and accessories which are produced in the USA and are shop tested and proven.

Let our trained Gorbel specialist help you determine your crane system requirements, and design and quote the complete overhead structure custom-built to your specifications. These systems may include Work station Cranes, Jib Cranes, Gantry Cranes, Hoists, Vacuum Lifters, and more. Contact Granquartz to choose one of many standard crane designs or design a system custom built for your shop.

Gorbel® Free Standing Work Station Bridge Cranes

- Weight Capacities from 250 to 4000 lbs
- Spans up to 30 Feet
- Easy Installation, Movement & Positioning
- Increased Productivity
- Steel & Patented Aluminum
- Enclosed Tracks
- Modular Design



GranQuartz is the only Nationwide Stone Industry Distributor authorized by Gorbel.

WORK STATION JIB CRANES

Versatile enough to perform a wide variety of local handling and positioning functions. Economical enough to be dedicated to individual work stations.

Gorbel Work Station Jib Cranes provide excellent coverage in circular areas not efficiently served by a main crane. Gorbel Work Station Jib Cranes increase productivity through easy boom rotation and trolley movement providing a rapid return on investment.

They also reduce injuries and improve safety, since only a low force is required to start and stop the boom rotation and hoist trolley. Ergonomic design makes for superior ease of movement, rotation and positioning.



Gorbel® Work Station Jib Cranes

- Weight Capacities from 100 to 2,000 lbs
- 200 Degree Rotation Column or Wall Mounted
- 360 Degree Rotation Floor Mounted
- Steel & Aluminum Enclosed Track Design
- Supports Tools, Air Balancers & Hoists



GranQuartz is an Authorized Distributor for Harrington Hoists. Custom quotes available upon request.

Manzelli® Evolution VAM 5PN/625 KTV Vacuum lifter

Patented inside-the-structure air system allows for some of the lifter's air lines to be concealed, reducing potential line snags, each vacuum plate has individual vacuum-loss indicators.

- Central vacuum plate rotates 90°, all other plates rotate 180°
- Power vertical/horizontal tilt from 0—90°
- Lifting capacity: 1,377 lbs. vertical/horizontal



Stock No.	Model	Capacity	Price
490181	VAM 5PN/625	625 kg	\$12,075.00

#490181

Manzelli® VAM 4PN Vacuum lifter

- Powered by air venturi system: 87 PSI, 4.6 CFM
- Four adjustable plates either in-line or positioned on 90° bars for four point configuration
- Power vertical/horizontal tilt from 0—90°
- Automatic safety alarm with sound & lights indicates sufficient vacuum power

Stock No.	Model	Capacity	Price
490500	VAM 4PN/500	500kg	\$5,449.85
490510	VAM 4PN/1000	1,000kg	6,979.35

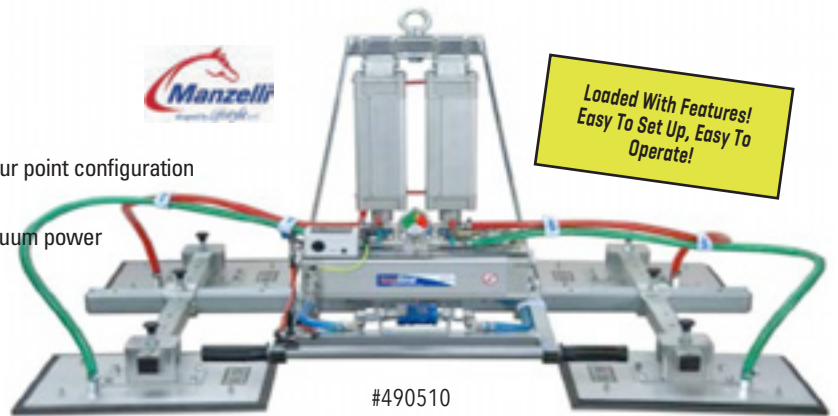

#490510

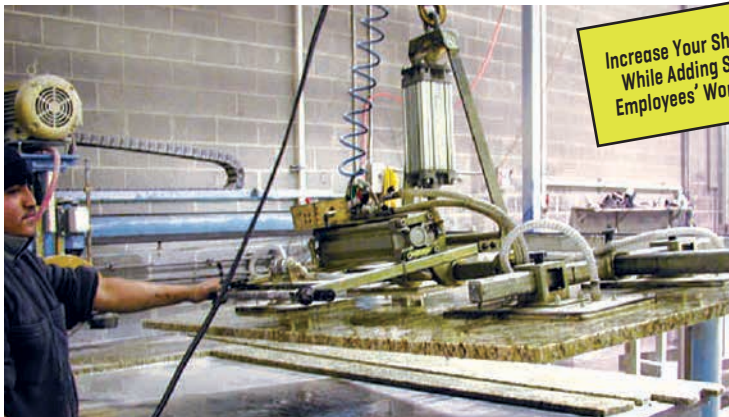

Increase Your Shop's Efficiency While Adding Safety To Your Employees' Work Environment!



Manzelli® EXENTIAL Vacuum lifters

Manzelli's Exential economy vacuum lifters are engineered with the same precise Italian high quality specifications as all of the Manzelli line but have been redesigned for better affordability. Like all Manzelli lifters, the Exential line includes standard features such as audible and visual alarms that typically cost extra with other lifters. Manzelli Exential gives you the high quality you demand, at a lower price, with safety you can depend on.

Stock No.	Description	Weight Cap.	Price
490800	4 Plate Air/Power Tilt	500 KG	\$3,794.99
490810	4 Plate Air/Power Tilt	1,000 KG	4,484.99
490814	2 Plate Air/Power Tilt	500 KG	3,105.00
490815	2 Plate Air/Power Tilt	1,000 KG	4,226.25

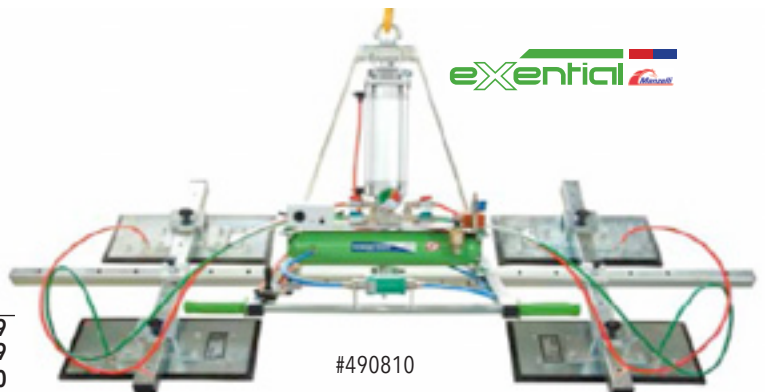

#490810

Manzelli® VAM 5PN Vacuum Lifters & Accessories

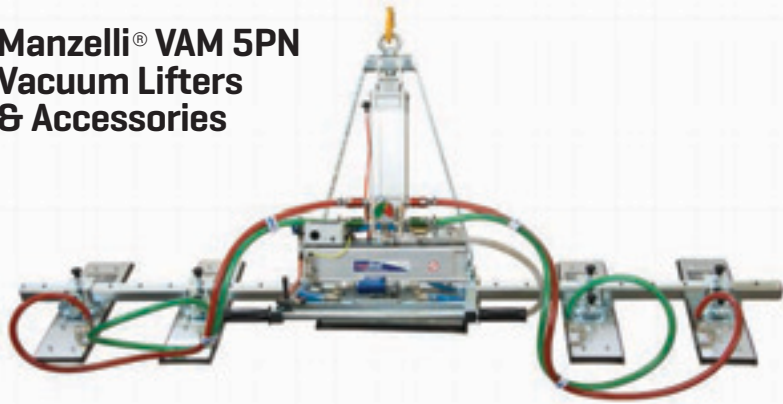

Upgrade existing Manzelli lifters to rotate vacuum pads independently.



#491500



#490503



#490523

Stock No.	Description	Weight Capacity	Price
490828	Lifter w/5 Plates with Rotating Supports625 KG	\$6,438.85

Stock No.	Description	Price
490502	LEFT Gasket w/Foam Seal, 480 x 230mm	\$68.43
490622	RIGHT Gasket w/Foam Seal, 480 x 230mm	68.43
490512	LEFT Gasket w/Foam Seal, 480 x 330mm	81.59
490614	RIGHT Gasket w/Foam Seal, 480 x 330mm	81.59
490582	LEFT Counter Plate w/Diamond Gummi, 480 x 330mm	139.73
490583	RIGHT Counter Plate w/Diamond Gummi, 480 x 330mm	139.73
490552	Black Spring Loaded Pad Adjustment Knob	39.68
490503	Manzelli Vacuum Gauge	22.14
490508	Manzelli Air Filter	37.95
490509	Manzelli Acoustic Alarm	402.50
490523	Lifter Control ("Joystick")	97.69

Stock No.	Description	Price
490220	PVC Nylon Braided Pneumatic Hose, Red Spiral, 1.7 Meters	\$15.79
490221	PVC Nylon Braided Pneumatic Hose, Green Spiral, 1.7 Meters	15.79
490827	Manzelli Display/Storage Stand with 3 Locking Wheels	641.69
490830	Manzelli 2 Small Plates w/Y Axis Bar and Supports	619.00
490831	Manzelli Small Plate with Support	217.35
490832	Rotating 90° Support for VAM5PN/625 Lifter Center Plate	166.95
491500	Rotating 180° Support for 500Kg Lifters	294.40
491510	Rotating 180° Support for 1,000Kg Lifters	292.10
490833	Manzelli Evolution Control Vacuum Device, VAM5PN/625	470.35
490834	Manzelli Economizer, Air Consumption Saver, VAM5PN/625	499.00

LIFTING & MATERIAL TRANSPORT ACCESSORIES



Aardwolf® Lifters

Safety: Due to the unique slim profile and design of the lifter, the Aardwolf requires minimum slab movement to engage and secure the slab. Also, because the angle of engagement is generally below the over-balance angle, operator danger is minimized.

Security: The Aardwolf Lifter has a superior force-multiplying factor of approximately 2.5 to 1, and is designed with a rubber jaw coating to prevent chipping and scratching.

Efficiency: The clamping mechanism is on the front of the slab which allows easy access and positioning of slabs.

Stock No.	Model	Grip Range mm/inches	weight/kg	load/lbs.	Price
750020	30	0-30 (0 - 1 1/4")12.52,640	\$589.99
750021	40	0-40 (0 - 1 1/2")16.52,640	639.99
750022	50	10-50 (3/8 - 2")16.52,640	659.95
750023	60	15-60 (3/4 - 2 1/2")21.52,640	789.95
750024	75	30-75 (1 3/4 - 3")21.72,640	789.95



Aardwolf® Automatic Slab Lifter 50A

The Aardwolf 50A Auto Slab Lifter eliminates the need for a second person to be at risk in the danger zone while lifting slabs. There is no locking latch to manage. The clamp is equipped with an Auto-Lock & automatically closes to grip the slab during pick-up & automatically opens to release the slab on set-down.

Stock No.	Model	Grip Range mm/inches	weight/kg	load/lbs.	Price
750445	50A10-50mm (0.4 - 2")12.52,640	\$790.45

Stock No.	Description	Price
750456	Locking Pin for 50A Lifter	\$4.45

Stock No.	Description	Price
750464	AL20A, Auto Lock/Unlock Thin Slab Lifter	\$807.83
750465	AL30A, Auto Lock/Unlock Slab Lifter	653.29
750466	AL40A, Auto Lock/Unlock Slab Lifter	790.95
750467	AL60A, Auto Lock/Unlock Slab Lifter	1,018.57
750468	AL75A, Auto Lock/Unlock Slab Lifter	1,018.57
750473	AL20AH, Auto Lock/Unlock Thin Slab Lifter w/ Guide Rails	860.52



Abaco® Automatic Slab Lifters

Designed to lift and move stone slabs with rubber covered clamp plates to safely handle the material. Opening and closing mechanism is fully automatic. Each time you lift up and lift down, the installed automatic locking latch will lock and release the clamping mechanism. Suitable for both natural and engineered stone surfaces.

- Use with a crane (or with a forklift truck) to clamp, lift and transport stone slabs
- Includes specialized swivel shackle, allowing the lifter and the material to smoothly rotate 360°

Stock No.	Model	weight/kg	load/lbs.	Price
750485	ALG40A-W	12.5	2,640	\$858.35
448574	ALG50A-W	12.5	2,640	868.70
750479	ALG60A-W	12.5	2,640	1,018.59
750480	ALG60A-W	12.5	2,640	1,030.59



Abaco® Little Giant Slab Lifters

Smaller version of Abaco's original slab lifter, designed to lift and move stone slabs with white rubber covered clamp plates to safely handle the material.

- Use with a crane (or with a forklift truck)
- Includes specialized swivel shackle, allowing the lifter and the material to smoothly rotate 360°

Stock No.	Model	weight/kg	load/lbs.	Price
058143	30ALG50-W	12.5	2,200	\$665.35
171039	50ALG50-W	12.5	2,200	761.40
750345	60ALG60-W	12.5	2,200	892.75
171041	75ALG75-W	12.5	2,200	936.85



Abaco® Porcelain Lifters

Specifically designed to lift and move materials which are flat, long, thin, delicate, and breakable such as porcelain, glass, ceramic and other surfaces. Clamping mechanism is fully automatic and the large surface contact area for the material is covered by rubber pads to prevent damage to materials when lifting.

- Two guide shafts lead the lifter into position
- 8 wheels- four lower wheels for easy maneuvering when not in use, four upper wheels provide pressure and act as a guide to center slab within the two clamps
- Made of strong, light weight aluminum

Stock No.	Model	weight/lbs.	load/lbs.	Price
448625	APL20-W	50.6	660	\$1,085.00

GranQuartz
DIAREX®



Diarex® Slab Lifter ASL-105

- Measures 20" at widest point, 10" across jaws for easy slab removal
- Steel catch is easy to engage and disengage
- Maximum Opening: 3 3/4"
- Lifting Capacity: 1,500 lbs.
- Weight: 42 lbs.

Stock No.	Price
500002	\$363.00

Abaco SWS02 Swivel Shackel & Lifting Lug

- 3,300 Lb. Capacity

Stock No.	Price
698386	\$47.00



Sling/ Braided Wire Rope

- 196" Length w/eye and eye loops

Stock No.	Price
750420	\$66.95

Nylon Rope Sling

- 16' Length w/Cordura Wrap

Stock No.	Price
750427	\$138.50



Wedge Safety Slab Tool

The Wedgee spacer the slab clamp can be easily inserted without risk of being caught in what OSHA calls the "Fall Shadow Zone".

Stock No.	Description	Price
750135	Slab Spacer	\$31.30

GranQuartz
DIAREX®



Diarex® Boom Hook

- Heavy duty cast iron construction
- Self-locking safety mechanism
- Swivel
- Capacity: 6,000 lbs.

Stock No.	Price
200282	\$41.00

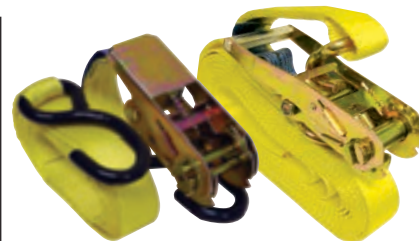

Nylon Tie-Down Straps

- The webbing is manufactured from high-quality nylon for cut/rip resistance and long wear, and is duty rated for durability

Stock No.	Description	Working Load Limit	Price
750325	2" x 30'	5,500 Lbs.	\$31.30
750326	1" x 10'	500 lb.	8.00

Woods Power Grip® Parts

Individual Pad Vacuum Shutoffs	Price
119278	\$48.53(ea.)

Closed Cell Foam Rings	Price
119283	\$103.00(ea.)

Xtreme Transportation Rack

Pro Series® Xtreme transportation racks are built to last. Easy 6-bolt assembly with optional wheel kit sold separately.

- Not for use with FULL SLABS
- Hot-dipped, galvanized steel construction
- 78 3/4" Long X 23 3/4" Wide
- Includes 8 uprights and straps
- 2,205 lb. Capacity
- Non-marking transparent rubber lined surfaces protect stone from damage during transport

Stock No.	Dimensions	Max Capacity	Steel Uprights	Price
063810	96" L x 43" W x 70 1/2" H.....	2,205 Lbs.....	8 (4 per side).....	\$1,675.65
063811	78" L x 43" W x 54" H.....	2,205 Lbs.....	8 (4 per side).....	1,362.15



Xtreme Slab Rack Wheel Kits



The wheel kit includes 2 fixed wheels and 2 swivel wheels for use with our Xtreme slab rack.

Stock No.	Description	Price
063815	Wheel Kit w/Release Pins.....	\$219.80

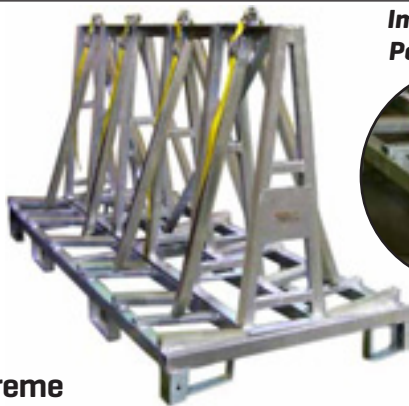

Improved Fork Pocket Design



Xtreme Short Transportation Rack

The Xtreme's 32" width fits between the wheel wells of a small pickup truck, allowing room for other tools and supplies. 39" height x 78" length allows transport of full width kitchen tops as well. Fork pockets on the sides and on one end, for easy loading into a truck bed by forklift.

- Store stone (or other material) up to 2,205 lbs.
- 78" x 32" x 40"
- NOTE: this product is not for use with FULL SLABS

Stock No.	Description	Price
063812	Short Rack	\$1,048.45

Xtreme Fabrication Table

Pro Series® Xtreme fabrication tables are built to withstand the most extreme shop conditions. Each table comes with 2 adjustable/removable center support braces, 2 fixed and 2 locking wheels.

- Hot-dipped, galvanized steel construction
- 78 3/4" Long X 23 3/4" Wide
- 1,100 Lb. Capacity
- Rubber lined surfaces protect stone surface
- Adjustable height, 32" – 44"



Stock No.	Description	Price
063025	Fabrication Table.....	\$575.25
063020	Swivel Caster for Fab. Table (1).....	15.99
063021	Fixed Caster for Fab. Table (1).....	11.99

Xtreme Slab Rack Kits

Pro Series® Xtreme slab racks are ideal for distributors and large shops that store slabs of granite and marble.

- Conveniently store slabs up to 9,400 lbs. between each post (4,700 lbs. capacity per post)
- 118" Long galvanized steel base rails
- Each post receiver is a welded reinforced channel

Stock No.	Description	Max Capacity Between Posts	Price
063024	Slab Rack Set	9,400 Lbs	\$1,450.00
	2 Base Rails (118" L), 16 Poles (59" H)		
063022	Bases, Individual (118" L),		401.35
063027	Poles, Each (59" H),		49.05
063028	Poles, Each (71" H),		52.67
063029	Poles, Each (79" H),		56.41



Xtreme Remnant Racks

Pro Series® Xtreme Remnant Racks are designed for stationary storage of small stone remnant pieces leftover from countertop fabrication. The Xtreme Remnant Rack is 118" long and 39 1/2" tall

- Not for use with FULL SLABS
- Store remnants up to 39" tall
- 1100 lb. capacity between posts.
- Includes two (2) base rails and twenty (20) upright posts
- Galvanized for protection and durability



Stock No.	Description	Between Posts	Price
063010	Remnant Rack Set	1,100 Lbs.	\$569.99
	2 Base Rails (118" L), 20 Poles (39.5" L)		

GranQuartz
DIAREX®



#770171
Diarex II
A-Frame Rack

Diarex® II A-Frame Transport Racks

- Several options for safely transporting finished work to the job site
- Not suitable for full slabs
- Rugged steel construction
- Cushioned rubber protective strips riveted to frame
- Lifting: Welded forklift brackets underneath on 4 sides and overhead crane rings on top
- Security: Steel uprights faced with rubber and equipped with ratcheted tie down straps to securely hold stone in place

Stock No.	Dimensions	Max Capacity	Steel Uprights	Price
770171	78"L x 43" W x 55" H	2,200 Lbs	8 (4 per side)	\$1,350.51
770172*	96"L x 44" W x 65" H	2,200 Lbs	8 (4 per side)	1,459.51
	(*No Wood)			

Stock No.	Description	Price
770173	Diarex II Optional Wheel Kit	\$76.25

Stock No.	Description	Price
100748	Diarex A-Frame Transport Cart, 6' Load Bar Assembly	\$32.70
100749	Diarex A-Frame Transport Cart, 8' Load Bar Assembly	38.70
759033	Diarex A-Frame Transport Cart, A-Section Replacement Rubber	18.81
759039	Diarex A-Frame Transport Cart, Base Replacement Rubber	6.10
759041	Diarex A-Frame Transport Cart, Load Bar Replacement Rubber	23.93



Solid welded hooks for lifting with hooks



Easy Self Assembly, Ships Flat



Precision manufactured step slotting & reverse angled rail tabs for added security



Optional Heavy Duty Wheel Kit (#770173)



Heavy Duty steel security poles are rubber channel lined and V-shaped for slab to secure spring loaded clamp



8 Forklift pockets on the sides



Rubber Tongue-in Groove Rail Padding Strips



Load Rating Certification Plate

GranQuartz
DIAREX®



Folds flat for storage.

Diarex® Fabrication Stand

Heavy duty steel height adjusting bolts and rubber lined top rail prevents damage to stone surface.

- Folds flat for easy storage
- Adjustable height 36" - 44"

Stock No.	Price
750127	\$163.45

GranQuartz
DIAREX



Wheels Included

Diarex® Demountable A-Frame Carts Single Sided Cart

- Length: 53" x Height: 53" x Width: 28"
- Not suitable for full slabs
- Channeled rubber platforms and inclined rails
- Maximum capacity: 1,500 lbs.
- Detaches from base via forklift brackets

Stock No.	Price
750120	\$866.55

Double Sided Cart

- Length: 53" x Height: 53" x Width: 38"
- Not for use with FULL SLABS
- Channeled rubber platforms and inclined rails
- Maximum capacity: 2,200 lbs.
- Detaches from base via forklift brackets

Stock No.	Price
750121	\$926.49



GranQuartz
DIAREX

Diarex® Fabrication Flip Cart

Great for flipping stone from polished side (bridge saw) to sawn side (CNC) during fabrication.

- Maxium Capacity 1,000 lbs.
- Not for use with FULL SLABS
- Dimensions: 49"H x 39"W x 48"L
- Holding Space: 37"H x 48"L x 8" Base Width
- Heavy duty casters

Stock No.	Price
750271	\$470.00



GranQuartz
DIAREX

Diarex® Basic A-Frame

Low-cost storage alternative, for indoor or outdoor use.

- Weight capacity: 12,000 lbs. per side
- Dimensions: L60" x W60" x H58"
- Full slab design w/weather resistant coating
- Wooden blocking secured with welded tabs
- Holes in the base rail drain water to reduce corrosion

Stock No.	Price
750252	\$228.85



GranQuartz
DIAREX

Diarex® Stone Cart

Inexpensive option for moving material in the shop or on the jobsite. Easy assembly with tools included with cart.

- 49" Long X 23" Wide X 48" Tall
- Not for use with FULL SLABS
- Non-marking urethane on steel casters
- 1,760 Capacity
- All steel construction

Stock No.	Price
500073	\$217.95



GranQuartz
DIAREX

Diarex® Self-Dumping Hopper

Hopper automatically dumps when bumper release contacts side of dumpster, returns to an upright and locked position automatically after it dumps. Includes a cable that may be operated from seat of the fork truck to manually dump the hopper. Locking chain is provided to secure the hopper to the fork truck. Leak proof design.

- 1 Cubic Yd.
- 41.5" x 60.5" x 43"
- 6,000 lbs. Capacity
- Fork pockets are 7.5" W x 2.5" H

Stock No.	Price
750231	\$1,445.50



GranQuartz
DIAREX

Diarex® CNC Tool Cart

- Holds 30 tools mounted on ISO 40 Cones
- 48 1/4" x 20 3/4" x 35 1/2"
- Shipping Weight: 198 lbs.
- 2 Locking casters

Stock No.	Price
750272	\$615.00

MATERIAL TRANSPORT EQUIPMENT



GranQuartz
DIAREX®

**Diarex®
Super Duty Fabrication Table**

The Diarex Super-Duty table was designed to be a simple, rugged table. It features 2" steel tube construction with 4 double-locking swivel casters. The Diarex Super-Duty also has a non-marking white rubber surface that can be replaced easily using silicone or any industrial adhesive.

- 1,000 lb capacity
- 96"L x 25"W x 43"H

Stock No.	Price
599999	\$544.95



4 Double
Locking Swivel
Casters



Easy
Assembly, 2"
Steel Tube
Construction

**Diarex®
Fabrication Table/Dolly**

Dual function table serves as a worktable in Horizontal position, and as a slab dolly in Vertical position.

Four adjustable levelling posts for stability & removable center brace for convenience when working with sink hole cut-outs.

Table fits through standard doorway for jobsite convenience.

- Length: 75"
- Height: 36"
- Width: 37"
- Width in Vertical position: 33"
- Maximum capacity 1,200 lbs.

Stock No.	Price
750090	\$794.61

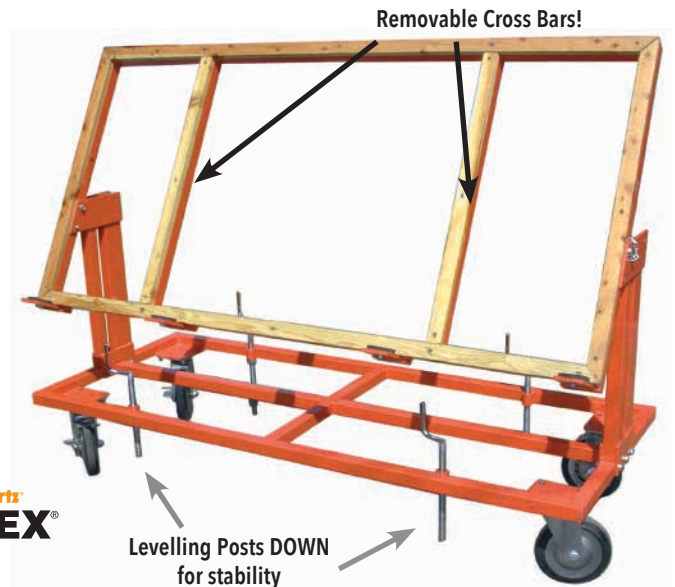

GranQuartz
DIAREX®

Levelling Posts DOWN
for stability

Removable Cross Bars!



GCT 96" x 72" Tilting Work Table

Tilting work table is extremely versatile and can be used in a flat position for fabrication or tilted up for transport.

- Heavy duty 8" solid swivel cast tires lock in place and include brakes
- 80° tilt with two safety pin locks
- Four slab holder wedges included
- 36" Tall
- 1,500 lbs capacity

Stock No.	Price
362383	\$3,257.95



Aardwolf® 36" Work Station

Adjustable work station for the stone industry. For router and track saw work.

- Easily portable for installers
- 80" long rails adjustable in 4" increments
- 19"—35" inside clearance to clear for sink cut outs
- 1.5 ton capacity
- Heavy duty rubber rail covers

Stock No.	Price
750317	\$435.00



Diarex® Modular Work Table

The Diarex Modular Work Table may be used in any number of configurations for the perfect workstation. Combine multiple units for large jobs or for one continuous work group. Table also features adjustable cross bars and all metal parts are powder coated.

- Rubber lined sturdy work table
- Adjustable feet
- Constructed of 18 gauge 2"x2" square tubing
- Main module 2130mm x 725mm (84" x 28 1/2")
- Includes 2 extension tables 915mm x 725mm (36" x 28 1/2")
- Weight: 75 kg. (165 lbs)
- Loading capacity: 300 kg. (660 lbs)
- Height: 42"- 46"
- Collapsible for ease of transport.

Stock No.	Price
100015	\$903.61

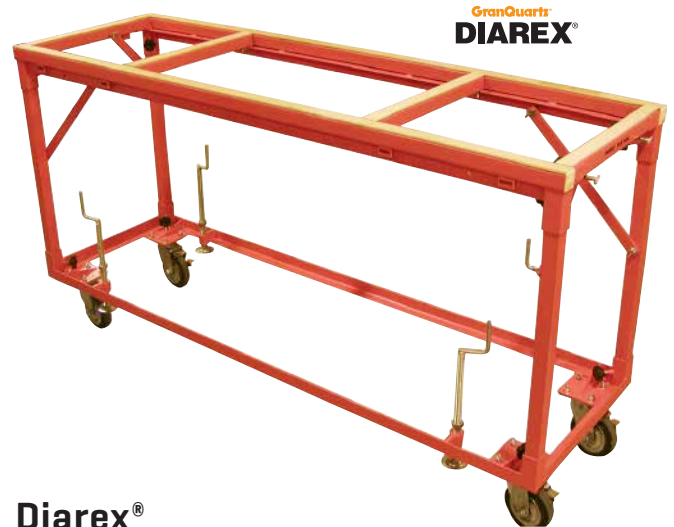

Diarex® Fabrication Table

With four adjustable levelling posts for stability & moveable center braces for convenience when working with sink hole cut-outs. Ends of table have connecting screws to join multiple tables together in various configurations.

- Length: 79"
- Height: 42"
- Width: 24"
- Maximum capacity: 1,000 lbs.

Stock No.	Price
750230	\$871.95

NEW!

Achilli
EVALUATOR IN STONE TECHNOLOGYExclusively At
GranQuartz

Achilli® SC500 LC Slab Cart

Achilli's SC500 LC (Lever Controlled) Slab Cart is a hydraulic motorized slab trolley that has proven to be indispensable when moving and carrying slabs from storage. Additionally, operators are able to lift and position granite or marble slabs onto the machine table with this granite cart. The SC500 LC is equipped with the following standard and optional features:

- Lifting – Users control materials easily because the worktop is adjustable in height from 25.5" to 38"
- Handling – Fabricators can control hydraulics easily with the lever controls unit
- Telescopic Panel – An operator can use the telescopic panel to access lever controls so loading large slabs is easy
- Frame – Stable and sturdy steel frame, equipped with 4 pneumatic wheels (2 pivoting). Resulting in a loading capacity of 1102 lbs.
- Worktop – The 54" × 79" worktop is fitted with hard wearing plastic wheels so slab loading and off-loading is easier



Stock No.	Description	Price
055613	SC500 LC Slab Cart	\$8,323.95

Achilli® SC500 PC Slab Cart

Achilli's SC500 PC (Pendant Controlled) Slab Cart is a hydraulic motorized slab trolley that has proven to be indispensable when moving and carrying slabs from storage. Additionally, operators are able to lift and position granite or marble slabs onto the machine table with this granite cart. The SC500 PC is equipped with the following standard and optional features:

- Lifting – Users control materials easily because the worktop is adjustable in height from 25.5" to 38"
- Handling – Fabricators can control hydraulics easily with the corded pendant control unit
- Telescopic Panel – An operator can use the telescopic panel to access lever controls so loading large slabs is easy
- Frame – Stable and sturdy steel frame, equipped with 4 pneumatic wheels (2 pivoting). Resulting in a loading capacity of 1102 lbs.
- Worktop – The 54" × 79" worktop is fitted with hard wearing plastic wheels so slab loading and off-loading is easier



Stock No.	Description	Price
750371	SC500 PC Slab Cart.....	\$8,549.95

Achilli
ESTABLISHED IN STONE TECHNOLOGYExclusively At
GranQuartz

NEW!

Achilli® SC800 LC Granite Carrier

Achilli's SC800 LC (Lever Controlled) Slab Cart is a hydraulic motorized slab trolley that has proven to be indispensable when moving and carrying slabs from storage. Additionally, operators are able to lift and position granite or marble slabs onto the machine table with this granite cart. The SC800 LC is equipped with the following standard and optional features:

- Lifting – Users control materials easily because the worktop is adjustable in height from 25.5" to 38"
- Handling – Fabricators can control hydraulics easily with the lever controls unit
- Telescopic Panel – An operator can use the telescopic panel to access lever controls so loading large slabs is easy
- Frame – Stable and sturdy steel frame, equipped with 4 pneumatic wheels (2 pivoting). Resulting in a loading capacity of 1102 lbs.
- Worktop – The 54" × 79" worktop is fitted with hard wearing plastic wheels so slab loading and off-loading is easier



Stock No.	Description	Price
053327	SC800 LC Slab Cart	\$11,362.95

Achilli® SC800 PC Slab Cart

Achilli's SC800 PC (Pendant Controlled) Slab Cart is a hydraulic motorized slab trolley that has proven to be indispensable when moving and carrying slabs from storage. Additionally, operators are able to lift and position granite or marble slabs onto the machine table with this granite cart. The SC800 PC is equipped with the following standard and optional features:

- Lifting – Users control materials easily because the worktop is adjustable in height from 25.5" to 38"
- Handling – Fabricators can control hydraulics easily with the corded pendant control unit
- Telescopic Panel – An operator can use the telescopic panel to access lever controls so loading large slabs is easy
- Frame – Stable and sturdy steel frame, equipped with 4 pneumatic wheels (2 pivoting). Resulting in a loading capacity of 1102 lbs.
- Worktop – The 54" × 79" worktop is fitted with hard wearing plastic wheels so slab loading and off-loading is easier



Stock No.	Description	Price
444367	SC800 PC Slab Cart.....	\$11,845.95

GROVES Shop Cart

Groves 4000# heavy duty shop carts ship complete with pull handle and rugged galvanized finish. Easy rolling 8" diameter casters are **MADE IN THE USA** with precision bearings. With two swivel brake casters and heavy duty rubber padding, the Groves Heavy Duty Shop Cart keeps stone slabs secure and stable.

- Not suitable for full slabs

Stock No.	Dimensions	Price
695635	54"L x 38"W x 62"H	\$747.00
695636	84"L x 40"W x 63"H	998.00
170543	84"L x 40"W x 87"H	1,233.00



GROVES Transport Rack TR-10

One of the strongest racks in the stone industry with 10,000 lb. capacity designed to hold all sizes of slabs.

- Four hold down ratchet straps secure load
- Four adjustable safety posts provide for safe removal of unstrapped loads that may shift unexpectedly
- Safety posts are stored at the end of the A-Frame during transport.

Stock No.	Dimensions (Rails)	Price
698461	96"L x 48"W x 99"H	\$2,665.00



GROVES Single Sided Slab Buggy

For all your stone transportation needs, this multi-purpose slab cart is built to last and easy to assemble.

- Not suitable for full slabs
- 10" pneumatic tires
- 5" swivel lock casters
- 2,000 lb. capacity

Stock No.	Dimensions	Price
698332	40"L x 24"W x 45"H	\$397.00



GROVES FC Six Wheeled Fab Cart

Transport material safely and easily with the Groves Fabrication Cart.

- Not suitable for full slabs
- Forklift pockets for loading and unloading
- Ships flat to save on freight
- 3,200 lb. capacity
- Ratchet straps secure the stone
- High quality casters are Made in the USA

Stock No.	Dimensions	Price
750411	48"W x 25"W x 53" H	\$596.00
750412	82"W x 25"W x 73" H	836.00



GROVES Foldable A-Frame Faf-60

Base arms fold up for ease of shipping and storage when frames are not in use. 12,000 pound total capacity, 6,000 per side.

- Not suitable for full slabs
- Heavy duty powder coated finish.
- Ships knocked down for lower freight cost.
- Ledge Length 20.5"

Stock No.	Dimensions	Price
750413	60"L x 60"W x 58"H	\$214.00



GROVES FS-24 24" Adjustable Fab Stand

Groves' fabrication stand can be used in the shop or on the road. Nesting and stackable for easy storage. Easily check your fit to the template before you go out on the job and store the stands out of your way.

Stock No.	Dimensions	Price
695478	36"-42" Adjustable Height	\$105.00

FORKLIFT BOOMS



Diarex® Large Forklift Boom

Our large telescoping boom is designed for use on 3 ton or larger forklifts. Telescoping 2-section rectangular tube steel construction.

- Extends and retracts from 1.9 meters to 3.4 meters, in 3 490mm increments
- Boom extension design prevents complete pull-out
- Fork pockets: 165mm W x 65mm H x 375mm to centers
- Capacity rating:fully retracted..... 5,290 lbs.
fully extended..... 1,320 lbs.

Stock No.	Price
750034	\$1,045.00



Diarex® Small Forklift Boom

Designed for use on 2 ton or 2 1/2 ton forklifts. Telescoping 2-section rectangular tube steel construction.

- Extends and retracts from 1.5 meters to 2.6 meters in 2 550mm increments
- Boom extension design prevents complete pull-out
- Fork pockets: 165mm W x 65mm H x 375mm to centers
- Capacity rating:fully retracted..... 3,300 lbs.
fully extended..... 1,100 lbs.

Stock No.	Price
750038	\$735.00



Heavy duty chain secures jib to forklift carriage

Diarex® Adjustable Height Booms

The pivot boom models are adjustable for height and length. The tilt feature provides extra height for lifter clearance when not in use.

MODEL 750118, 3 Ton Boom

- Extends and retracts from 1.9 meters to 3.5 meters, in 490mm increments
- Provides an additional 2.3 meters in height
- Boom extension design prevents complete pull-out
- Heavy duty chain secures jib to forklift carriage
- Adjusts from 0 - 50°
- Fork pockets: 165mm W x 65mm H x 375mm to centers
- Capacity rating, 3 Ton Boom: fully retracted..... 5,290 lbs.
fully extended..... 1,320 lbs.

MODEL 750114, 1.5 Ton Boom

- Extends and retracts from 1.5 meters to 2.6 meters, in 550mm increments
- Capacity rating, 1.5 Ton Boom: fully retracted..... 3,300 lbs.
fully extended..... 1,100 lbs.

Stock No.	Description	Price
750118	3 Ton Boom	\$1,500.00
750114	1.5 Ton Boom	1,209.00

Liftmaster® Forklift Booms

Unique performance, convenience and safety features are built into every Lift Master Boom. Fabricated from structural steel with welding to meet AWS creates a rugged and durable boom that will provide long term service.

Telescoping units extend to 144" and come with an infinitely adjustable locking screw (except orbit booms which feature a

spring loaded detent). Fork pockets for 4,000 pound capacity models measure 7½"W x 2½"H usable on 24" centers. Usable fork pockets are 7¼"W x 2¼"H for 6,000 and 8,000 pound capacity option. A 36" safety restraint secures the boom to the fork truck for safe operation.



Liftmaster® Telescoping Vestil Econo-Booms

- Extends to 144"

Stock No.	Description/Capacity	Price
751424	Telescoping Boom-4,000 lb.	\$1,068.20
750340	Telescoping Boom-6,000 lb.	1,526.95
698183	Telescoping Boom-8,000 lb.	2,324.89



Abaco Telescoping Fork-Lift Boom

- Designed for the stone industry
- For use on 2 & 2-1/2 ton fork lift trucks
- Weight Capacity: Min. 1,100 - Max 4,400
- Boom Length: Min. 42.5" - Max. 94.5"

Stock No.	Price
171045	\$776.75

MATERIAL RACKING/STORAGE



Groves® Remnant Rack

Easily store cutoffs, finished products, remnants, vanity tops in a convenient organized manner. SAFETY WARNING: Maximum weight allowed per opening is 500 lbs. when using 2 x 4s.

- Constructed of extruded aluminum
- Posts are 1" diameter steel coated with galvanized finish
- Outside rails are designed with slots to hold 2 x 4
- Posts can be removed for easy loading and unloading of product

Stock No.	Dimensions (Rails)	Price
750409	60" L x 6" W x 3" Thick	\$398.00

MATERIAL RACKING/STORAGE

**Aardwolf®
Slab Racks**

- Store slabs up to 9,400 lbs. between post (4,700 lbs. capacity per post)
- Galvanized steel base rails, 5.5" x 3.9" x 9'10" long, can be butted together for desired length
- The center of rails has 50mm square holes spaced 5mm apart allowing for adjustment of post in 55mm increments for maximum storage efficiency.
- Rectangular tube steel uprights, 50 x 50 x 5mm made from steel AS 1163-450 LO
- Uprights are topped with square rubber post caps
- Timbers are attached to the base rails to prevent scratching

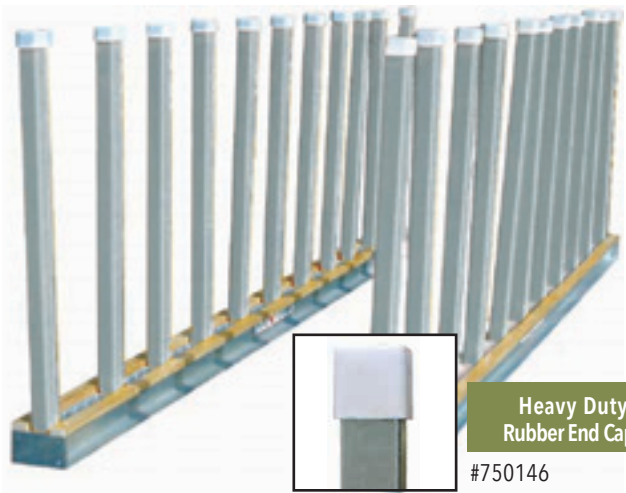

Heavy Duty Rubber End Caps
#750146

For specific use and technical information please refer to Aardwolf's website:
http://www.aardwolf.com.au/slab_fabricator.php

Stock No.	Description	Price
750150	Slab Rack With 20 - 4' Tall Uprights.....	\$1,550.00
750151	Slab Rack With 20 - 5'3" Tall Uprights.....	2,029.95

Build your own custom rack using interchangeable parts:

Stock No.	Description	Price
750141	Slab Rack Post Medium, 4' Tall	\$40.55
750142	Slab Rack Post Large, 5'3" Tall	55.95
750146	Slab Rack Post Cap	2.95
750148	Slab Rack Base Rail, 9' 10" Length.....	493.30



**Aardwolf®
Bundle Racks**

Stores bundles or slabs up to 26,000 lbs. per bay [13,000 lbs. capacity per post].

Aardwolf bundle racks are ideal for distributors and shops that stock large bundles of granite and marble. As inventory is used post can be adjusted horizontally to make space for replacement slabs and bundles. Buy ready made kits or individual components.

Stock NO.	Description	Price
750237	Bundle Rack Kit: 2 Base Rails w20 - 5' 3" Post.....	\$2,699.00
750235	Bundle Rack Post 5' 3" Tall (1,600mm) w/cap.....	91.00
750147	Bundle Rack Post Cap (fits #750234, #750235).....	3.65
750399	Bundle Rack Base Rail (ONE), 9' 10" L (3 meters).....	501.05

**Abaco SEK-RCO
Remnant Rack**

Abaco's SEK-RCO Rack is a great option when storing stone remnants no more than 5" taller than top of posts (32" max), not intended for use with full slabs.

- 118-1/8" x 1-5/8" x 27-1/2"
- Sturdy, Reliable & Space saving
- Not intended for use with full slabs
- Weight (per set): 130 lbs
- Max capacity (between posts): 2,200 lbs
- Loading capacity (per set): 14,000 lbs
- Comes with set of 2 bases and 20 poles

Stock No.	Price
698318.....	\$429.95





Abaco One Stop A-Frame

- Compatible with overhead cranes and forklift
- 2,200 lbs. for rolling or lifting by eyelets
- 4,400 lbs. stationary position
- Not intended for use with full slabs
- Lifted by forklift through fork holes in base.
- 4 adjustable rubber lined ratchet securing bars
- 4 quick release removable casters
- 2-swivel/brake casters

Stock No.	Description	Price
697067	71.1" x 43.3" x 62"	\$1,682.30
697070	86.1" x 43.3" x 78"	1,960.35



Abaco AWT7253 Fabrication Table

- 76" x 24" x 40"
- Capacity 660 lbs.
- Includes heavy duty rubber lining for protection of material (#693470-Black, #444347-White)
- Built-in brackets that make individual tables easy to join together to create a work station.

Stock No.	Description	Price
693470	Work Table, With Casters	\$745.00
444347	Work Table, With White Rubber	754.95



Abaco AFS3139 Fabrication Stand

Designed to support stone while polishing, cutting, and many other uses. Top is covered in rubber to protect material.

- Sold in pairs
- Folds for compact storage and easy transporting
- Portable
- Compact

Stock No.	Description	Price
692850	AFS3139 Stand, Set of 2	\$401.50

Diarex® Stone Buggy

- Single sided dimensions: 48.8"x25"x 45.6"
- Single sided capacity: 800 lbs.
- Sturdy structure designed to eliminate any risk of slab tipping over
- Thick rubber lined rails prevent slippage
- Two ratchet tie down straps included
- Heavy duty 5" swivel casters with locking brakes
- Net weight: 103 lbs.
- Not intended for use with full slabs



Stock No.	Description	Price
698106Single Sided Buggy	\$517.75
698107Double Sided Buggy	773.06



Cross-Carry Strap

High strength slip-resistant woven hemp strap.

- Can be used with Diarex® Stone Carry Clamps to support weight
- Each strap should lift no more than 100kg
- Adjustable buckles & leather pad to safely "seat" stone

Stock No.	Price
500017	\$132.35



2-Piece Carry Clamps

Stone carry clamps allow the fabricator or installer to lift and carry slabs alone. The clamping action actually increases with the weight of the slab. Designed with cushion to protect the stone. Sold in pairs. Easy to use.

Stock No.	Desc.	Price
692672	... Standard Model	\$310.25
688730	... White Rubber Pads..	325.95

Stone Pro SP137 Stone Carry Clamps

Re-designed with a new, improved pad handle. Safely lift and carry your stone work pieces.

- Sold in pairs



Stock No.	Description	Price
500129	(2) Stone Carry Clamps	\$229.95
500016	Replacement Pad	74.75

Diarex® Lite Stone Panel Carriers

Aluminum body carry clamps (sold in pairs) with rubber-lined spring loaded pads protect stone surface.

- 350 lb. capacity per clamp
- Non-marking rubber pads
- Automatic tension adjustment
- Maximum opening = 2 1/2" (6.3cm)

Stock No.	Price
200275	\$147.00/Pair



Diarex® Stone Carry Clamps

Lift and move slabs or finished stone with our high quality non-marking carry clamps.

- Sold in pairs
- Non-marking foam pads protect stone surface from scratches or damage
- Maximum opening = 1 15/16" (4.9cm)
- 350 lb. capacity per clamp

Stock No.	Description	Price/Pair
500069	Stone Clamps	\$272.00
500072	Replacement Pad (1)	13.25



Aardwolf® Heavy Duty Stone Carry Clamps

Designed with a wider span in between the handles for increased leverage and load control when lifting. Carry clamps sold in pairs.

- 440 lb. capacity per clamp
- 0 – 2 1/8" Grip
- Ribbed rubber gripping surface

Stock No.	Price/Pair
500090	\$283.00

The MOST VERSATILE RAMP EVER!



Rolls UP For EASY STORAGE!

Roll-A-Ramp® HD™

The new ROLL-A-RAMP HD portable transport ramp can be used to get equipment and materials up or down a flight of stairs, into or out of a vehicle or over obstacles. The ramp rolls up or can be folded for storage in small spaces where standard fixed ramps won't fit. Custom lengths are available and ramps can be shortened quickly if needed. Ramps are modular allowing additional sections to be added to extend the length.



Exclusively At GranQuartz

- Available in 6', 8' or 10' Lengths.
- Light weight
- Rolls down or folds for compact storage
- Custom lengths available

Stock No.	Description	Price
710561	8' Length x 36" Width, 1,500 Lb. Capacity	\$1,410.95
710562	10' Length x 36" Width, 1,400 Lb. Capacity	1,765.95

GranQuartz DIAREX®

Diarex® 3-Wheel Stone Dolly

Rubber lined channel; offset axle allows caster to share the weight. Designed to move cut-to-size pieces.

- 880 lb. maximum capacity
- 33"L x 14" w at the axle x 4" w / channel
- Weight: 36 lbs.
- Wheelbase 13 1/2"



Stock No.	Price
750036	\$236.95

GranQuartz DIAREX®

Diarex® Small Dolly

Rubber lined channel. Designed to move small drops and cut-to-size pieces.

- 16"L x 9"w at axle x 4"w / channel



Stock No.	Price
750035	\$113.95

Abaco® Self-Locking Trolley

Heavy trolley with 2 pneumatic tires. Vulcanized rubber in bottom receiver to avoid chipping or damaging stone.

- Grip range: 3/8" - 4"
- Lifting capacity: 880lbs.
- Seat length: 19-1/3"
- Net weight: 78 lbs.



Stock No.	Price
171044	\$506.15

Abaco® 8" Stone Dolly

- 19-5/8" x 9-7/8" x 3-1/8" channel
- Solid rubber wheels
- Vulcanized rubber on bottom to avoid chipping
- Maximum capacity: 660 lbs.
- Net weight: 22 lbs.



Stock No.	Price
690790	\$115.95

Diarex® Self-Locking Trolley

- Padded clamps secure slab while protecting stone
- Stone rides smoothly on large pneumatic tires
- Grip Range: 0" - 3.9"
- Lifting Capacity: 880 lbs
- Steering Handle Height: 35"
- Seat Length: 20"
- Weight: 60 lbs.

GranQuartz DIAREX®



Stock No.	Price
750037	\$434.00

Diarex® 3-Wheel Self-Locking Trolley

- Grips material automatically & securely
- Shipping weight: 62 lbs.
- Clamp width: 0-4"
- Capacity: 880 lbs
- 2 Rubber wheels
- Clamping supports & base are rubber padded

Stock No.	Price
750275	\$415.00



Third wheel for added support

LET US DO THE HEAVY LIFTING

Pro-Lift Automatic

- Compact. Stable. Solid.
- Wireless remote for ease of use
- 1,000 lb (450 kg) capacity; weighs only 74 lb

The Pro-Lift helps to **reduce the risk of injury** by doing the heavy lifting for you! That means you can send **less people to the install**. It enables you to **safely tilt countertops onto cabinets** with ease. The Pro-Lift easily fits into your installation trucks and vans and can be used to lift, lower and transport stone, heavy doors or just about any heavy panel you need to move more safely.

FIND OUT MORE!

(530) 748-2260
omnicubed.com



MADE IN THE USA—FROM
US AND IMPORTED PARTS



Omni Cubed®
ENGINEERING TO A HIGHER POWER

(Paid Advertisement)

OMNI CUBED TRANSPORT EQUIPMENT

Pro-Cart AT1

The Pro-Cart AT1 is designed to overcome the challenges of moving stone over curbs, stairs, and other rough terrain such as gravel or lawns. The cart easily and safely transports large and cumbersome stone, reducing the physical burden on workers. Integrated clamps and high ground clearance allow popping wheelies or climbing stairs with stone attached. Equipped with 8" non-marking, flat-free tires that last longer and are more reliable than pneumatic tires. Strong aluminum tubing makes this cart lightweight and highly durable.

- Designed to easily clear and rest on stair treads
- Clamps onto stone to cross any terrain
- 750 lb capacity
- Weighs less than 50 lb
- Clamp opening 73mm (2.88")

Stock No.	Description	Price
350300	Pro-Cart AT1	\$775.00
350301	Pro-Cart AT1 Folding Kit	80.00
350254	Pro-Cart Multi-Top Accessory (set)	185.00



Folding Kit
Sold Separately



Pro-Cart AT2

The Pro-Cart AT2 is designed to overcome the challenges of moving stone over curbs, stairs, and other rough terrain such as gravel or lawns. Equipped with all the same features as the Pro-Cart AT1 model, PLUS collapsible clamp uprights for easy removal and tilting of stone, a built-in Folding Kit that rotates caster rails beneath the support beam for easy storage, 10" flat-free tires, and an adjustable wheelbase for matching variable stair treads.

- 1,000 lb capacity
- Weighs less than 65 lb
- Clamp opening 73mm (2.88")
- Folds to under 13" wide

Stock No.	Description	Price
350302	Pro-Cart AT2 2014	1,195.00



Pro-Dolly™ HD1

The Pro-Dolly™ HD1 allows easier transport and installation of countertops. An aluminum frame makes this dolly extremely compact and lightweight. The dolly's low profile allows more clearance for tall pieces through doorways. This product is often used in pairs to handle extra large pieces (up to 1,500 lb). Integrated clamps hold countertops securely on the dolly, so the dolly can stay attached from fabrication shop to final placement. The HD1 features 8" non-marking, flat-free tires with excellent shock absorption, and a rubber-lined support rail to prevent damage to stone.

- 750 lb capacity
- Clamp opening 73mm (2.88")

Stock No.	Description	Price
350304	Pro-Dolly HD1	\$375.00



Pro-Dolly™ HD2

The Pro-Dolly™ HD2 weighs only 35 pounds, yet is strong enough to accommodate a half-ton load. The dolly's low profile allows more clearance for tall pieces through doorways. This product is often used in pairs to handle extra large pieces (up to 2,000 lb). Integrated clamps hold countertops securely on the dolly, so the dolly can stay attached from fabrication shop to final placement. The HD2 features 10" non-marking, flat-free tires with excellent shock absorption, and a rubber-lined support rail to prevent damage to stone. The HD2 model has an oversized clamp opening for transporting countertops up to 5" thick, such as tops with miter laminated edges.

- 1,000 lb capacity
- Clamp opening 130 mm (5.13")

Stock No.	Description	Price
350305	Pro-Dolly HD2	\$650.00

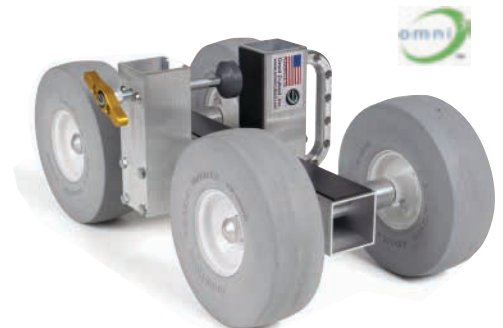

Made in the USA
from US & imported parts.



#350306

Omni Cubed Pro-Lift Automatic Heavy Lifting Countertop Installation Cart

The Pro-Lift Automatic provides a safer means of stone transportation and installation. It has been designed to reduce physical strain and risk of injury, while increasing productivity and efficiency. The cart accommodates any size countertop up to 1,000 lb. Use it to lower, lift, and roll extremely large pieces around the shop and install location, as well as assist with final countertop placement. The power lift feature elevates stone up to 45" from the ground, and enables controlled tilting for easier, less hazardous installation. The cart features a strong aluminum frame, yet only weighs 74 lb. The Pro-Lift is powered by a long-lasting rechargeable tool battery, controlled via wireless remote, and has an integrated level, stone clamp, and kickbrake for added safety. The cart also features 10" shock-absorbing, non-marking, flat-free tires

- Reduce physical strain and risk of injury
- Accomplish more with less people
- Unload slabs easier, safer, and faster than traditional methods
- Enables controlled tilt for easier countertop installation
- Wireless remote allows workers to position themselves in safer areas around the stone
- Commonly used with Aqua-Jaw™ Carry Vise™ for optimal material control
- Engineered for optimum stability and maneuverability
- Lift stone up to 45" (from ground to support rail)
- Clamp opening: 4.5" (115 mm)
- Powered by 28V rechargeable lithium-ion battery
- 1,000 lb capacity; weighs only 74 lb
- 10" non-marking, flat-free, shock absorbing tires
- Integrated remote storage cage, level, and kickbrake

Made in the USA from US & imported parts.

Stock No.	Description	Price
350306	Pro-Lift Automatic.....	\$4,995.00



Powered by a 28 volt lithium-ion rechargeable battery pack

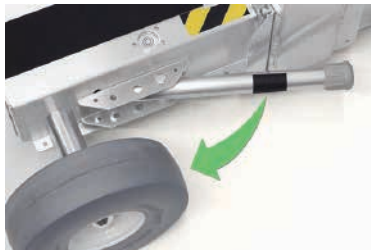

Integrated kickbrake for optimal support and stability



Wireless remote allows workers to stand in safe zones



Enables the unloading of large pieces out of trucks (and off the A-frame) to be much safer, faster, and easier

OMNI CUBED MATERIAL HANDLING



Optional Handle Kit (add 2 handles to each set)

Aqua-Jaw™ Carry Vise™ PATENT US640522

The Aqua-Jaw™ Carry Vise™ promotes safer, more ergonomic lifting to reduce strain and injury. This all-weather carry clamp is designed to grip wet stone, and can be used to carry stone up stairs. Aqua-Jaws are the highest capacity carry clamps available, and open wide for thick edges.

- 800 lb capacity per pair
- Clamping range 4 mm - 108 mm (0.15" - 4.25")
- Optional Handle Kit allows four people to share the load

Stock No.	Description	Price
112345	Aqua-Jaw Carry Vise (set).....	\$595.00
112346	Aqua-Jaw Handle Kit (4 extra handles)	60.00



Mega-Jaw™ Carry Clamp

The Mega-Jaw™ is a quick and easy, gravity-assisted carry clamp. The clamps distribute weight to both arms, reducing strain and enabling safer, more ergonomic carrying of stone. The clamps feature strong, lightweight aluminum arms and durable, non-marking rubber gripping pads. The gravity-assist action makes the clamps grip tighter as more weight is lifted, for a secure hold on thick stone and concrete countertops.

- 500 lb capacity per pair
- Clamping range 6 mm - 61 mm (0.24" - 2.4")
- Precision-machined aluminum arms have adjustable tension

Stock No.	Description	Price
112347	Mega-Jaw Carry Clamp (set).....	\$295.00



No-Spin Edger™

The patented No-Spin Edger is an inexpensive solution for eliminating vertical surface damage during polishing and refinishing. This rigid aluminum backer replaces traditional backer pads, and features a free-floating top disk with a built-in bumper that stops spinning while the polishing pad continues to work beneath it. This innovative system acts as a protective roller-guide against perpendicular surfaces, and eliminates costly damage caused by the edge of spinning pads. The No-Spin Edger allows fast, precise, and consistent cut patterns along edges and in corners, while greatly reducing time, labor, and worker fatigue.

- Works great for stone and concrete surfaces
- Disc acts as built-in guide to allow fast and precise cut patterns
- Greatly reduces worker fatigue on large refinishing jobs

Stock No.	Description	Price
413917	4" No-Spin Edger	\$150.00
513917	5" No-Spin Edger	160.00
713917	7" No-Spin Edger	195.00

Low-Profile Bumper Accessory

The Low-Profile Bumper accessory for the No-Spin Edger protects faucet fixtures and other lower profile vertical surfaces from the edge of spinning abrasive pads used for polishing or refinishing. Durable plastic ring snaps onto the No-Spin Edger, lowering the contact area of the free-floating disk.



- Clean, consistent polish line against low-profile edges
- Available for 4" or 5" Diameter No-Spin Edger

Stock No.	Description	Price
350288	4" Low-Profile Bumper	\$25.00
350289	5" Low-Profile Bumper	25.00

Dust Shroud Polisher Adapters

For dust control, use the Omni Cubed Dust Shroud Adapter to attach the DustBuddie® to your hand polisher, then attach the Omni Cubed 7" No-Spin Backer Pad.



- For 7" Diam. No-Spin Backer Pads

Stock No.	Description	Price
350295	Makita/Bosch Adaptor-7"	\$30.00
350296	DeWalt DWP849 Adaptor-7"	35.00

Lam-Clamp™

The Lam-Clamp is designed for producing faster edge laminations and superior seams, with a clamping range from 36mm-66mm (1.4" to 2.6").

- Hidden clamp threads to protect from epoxy contamination

Stock No.	Description	Qty	Price
350200	5" Lam-Clamp	10	\$375.00
350201	10" Lam-Clamp	10	395.00
350202	2' Lam-Clamp	1	135.00
350203	3' Lam-Clamp	1	175.00
350204	4' Lam-Clamp	1	225.00
350205	6' Lam-Clamp	1	295.00



Made in the USA from US & imported parts.

Miter-It™ Clamps

PATENT US9393765

The Miter-It™ clamp is an easy-to-use jig that allows finished-side-up miter laminations. Not flipping the material offers numerous benefits: increased safety for workers, reduced risk of damage to the material, and keeping the seam in view during lamination. The Miter-It securely holds edges at 90°, eliminating the need for a helper to position the material. The clamp's weight and non-marking, non-skid contact surface hold the product and miter piece in place.

- More efficient than taping methods alone
- Highly durable steel construction with powder-coat finish
- Accommodates laminated edges from 1.5" - 6"

Stock No.	Description	Qty	Price
340314	Miter-It Original	1	\$195.00
350307	Miter-It Corner	1	395.00



Miter-It™ Kit

Easy to use clamping system uses minimal shop (compressed) air to power the 1/2 CFM venturi vacuum generator for secure clamping.

- Securely holds edges
- No flipping for gluing

Stock No.	Description	Price
350320	Miter-It Auto, Electric, 2-Clamp Kit w/Cups+Case ...	\$1,095.00
350321	Miter-It Auto, Pneumatic, 2-Clamp Kit w/Cups	895.00
350316	Miter-It Auto Clamp	360.00
350317	Venturi Vacuum Generator	195.00

MITERS MADE EASY

Miter-It™ Auto Electric & Pneumatic

- Easy. Fast. Efficient.
- Only takes one person to set perfect seams
- Miter finished side up—keeps the seam in view!

Why waste labor and time when we have made it so simple for you to set seams...all while **saving your back**. Miter finished side up—no more having to “flip” just to glue, this product is much more **efficient and accurate** than taping methods alone. Fine-tune adjustments for ultimate seam control.

FIND OUT MORE!

(530) 748-2260
omnicubed.com



MADE IN THE USA—FROM
US AND IMPORTED PARTS



Omni Cubed®
ENGINEERING TO A HIGHER POWER

(Paid Advertisement)



Sink Hole Saver™ Edge

The NEW Sink Hole Saver™Edge is the perfect solution for strengthening and protecting cutouts, backsplashes, and other fragile pieces.

- Wider clamping range 0.7" – 2.1" (18mm to 53mm)
- Improved tightening knobs
- New rubber bumper guards to protect finished edges

Stock No.	Description	Price
321895	4' Sink Hole Saver Edge	\$275.00
321896	6' Sink Hole Saver Edge	350.00
321897	8' Sink Hole Saver Edge	395.00



Sink Hole Saver™ Manual

The NEW Sink Hole Saver™Manual is a surface-mounted reinforcement system that strengthens fragile materials during lifting, transportation, and installation.

- Proprietary, non-marking vacuum cups with triple sealing rings
- Easy to read red-line pressure indicators
- Easy-grasp knurled knobs for cup adjustment

Stock No.	Description	Price
321898	4' Sink Hole Saver Manual.....	\$250.00
321899	6' Sink Hole Saver Manual.....	350.00
321900	8' Sink Hole Saver Manual.....	395.00



Sink Hole Saver™ Auto

Sink Hole Saver Auto is the perfect solution for thin materials, rounded countertops, and challenging installations such as vertical panels and high-low drops. Quick-release valves for fast, easy removal.

- Bigger, stronger vacuum pump with greater airflow rate
- Pump runs on an all-new Rechargeable Power Pack that lasts up to 5 hours on a single charge

Stock No.	Description	Price
321901	4' Sink Hole Saver Auto	\$695.00
321902	6' Sink Hole Saver Auto	795.00
321903	8' Sink Hole Saver Auto	850.00



Sink Hole Saver™ Extension Kit



Sink Hole Saver™ Handle Kit



Sink Hole Saver™ Angle Brackets

Stock No.	Description	Price
321905	S.H.S. Vert. Lifting Handle	\$75.00
321906	S.H.S. Rechargeable Power Pack	185.00
350209	S.H.S. Angle Bracket.....	110.00
321908	S.H.S. Edge Clamp Assembly	65.00
321909	S.H.S. Vacuum Cup Assembly.....	75.00
321910	S.H.S. Pump.....	185.00



Sink Hole Saver™ Slider

Adjustable-length, surface mounted reinforcement device that offers exceptional versatility and convenience. Same tool as the Sink Hole Saver Manual, with the added advantage of a quickly customizable length. Includes two 4' stiffening rails combined with a pre-mounted Extension Bracket Kit, and 4 non-marking vacuum cups that can be repositioned around cutouts, or spaced out to completely support fragile material. Fully extends to 90" and collapses down to 51" for smaller pieces and convenient storage.

- Versatile, convenient, customizable
- Quickly extend or collapse to completely support fragile materials
- Non-marking vacuum cups can be easily repositioned along material or around cutouts
- Extension range: 51" - 90" (1.3 m - 2.28 m)

Stock No.	Description	Price
350050	Sink Hole Saver Slider	\$450.00



Edge Seamer™

Helps take the twist out of sink rails and cutouts, and dials-in flawless seams along material edges. Works great along any edge to ensure a consistent, even joint. Clamps have a wide range to accommodate many standard edges with rubber bumpers to protect finished details. Integrated rail pads allow enough flexibility for fine adjustments on each side of seam, to compensate for the slightest unevenness. Fast, easy to use with greater precision and reliability than shims only.

- Perfect solution for leveling seams along cutouts
- Fast, easy, and more reliable than shims alone
- Integrated rail pads for fine-tuning
- Rubber bumpers protect finished edges
- Clamping range: 0.55" - 1.97" (14 mm - 50 mm)

Stock No.	Description	Price
350049	Edge Seamer.....	\$150.00

Stealth Grip 8" Vacuum Cups

Made with non-marking gray rubber. Set includes 2 gray non-marking 8" manual pump suction cups and a handy storage bucket. The bucket is an excellent way to protect the cups when not in use, or store and carry other items needed on the jobsite.

- Versatile, convenient, customizable
- Quickly extend or collapse to completely support fragile materials
- Non-marking vacuum cups can be easily repositioned along material or around cutouts
- Extension range: 51" - 90" (1.3 m - 2.28 m)

Stock No.	Description	Price
350113	Stealth Grip 8" Vac. Cups, Qty. 2	\$195.00



NEW!



Nano Auto Stealth Seamer™

Joins and levels countertops to consistently create high-quality, even seams with more control and less effort than traditional methods. The product's proprietary non-marking cups feature our FTS™ (Flexible Triple Seal) technology that locks-in vacuum and provides optimum hold—even on textured and leathered materials. The Nano's wide-open design and high-clearance driveshaft keep seams extremely accessible for epoxy application and removal—no need to waste time scraping the seam after glue has set.

- 5" cups allow seaming smaller pieces and tighter spaces
- More control and less effort than shims and screws
- Proprietary, non-marking vacuum cups won't stain surfaces
- FTS™ vacuum cup technology for optimum hold on textured and leathered materials
- Easily access seams for epoxy application and removal
- Non-spinning leveling feet won't scratch surfaces
- Smooth-turning knurled roller opens and closes seams with ease
- Powerful, compact pump maintains max pressure for entire system
- Runs on AC power or AA batteries



Stock No.	Description	Price
350310	Stealth Seamer Nano Auto..... (Pair with toolbox)	\$795.00



Made in the USA
from US & imported parts.

Nano Manual Stealth Seamer™

Joins and levels countertops to consistently create high-quality, even seams with more control and less effort than traditional methods. The product's proprietary non-marking cups feature our FTS™ (Flexible Triple Seal) technology that locks-in vacuum and provides optimum hold—even on textured and leathered materials. The Nano's wide-open design and high-clearance driveshaft keep seams extremely accessible for epoxy application and removal—no need to waste time scraping the seam after glue has set.

- 5" cups allow seaming smaller pieces and tighter spaces
- More control and less effort than shims and screws
- Proprietary, non-marking vacuum cups won't stain surfaces
- FTS™ vacuum cup technology for optimum hold on textured and leathered materials
- Easily access seams for epoxy application and removal
- Non-spinning leveling feet won't scratch surfaces
- Smooth-turning knurled roller opens and closes seams with ease
- Easy to read indicators help monitor vacuum pressure at a glance
- Re-pump cups as needed without loss of remaining pressure

Stock No.	Description	Price
350311	Stealth Seamer Nano Manual (single).....	\$225.00

Stealth Seamer 90° Manual

For creating high-quality perpendicular seams such as mitered aprons, butt-joints, and compound corners without the hassle of straps or bar-clamps. Can also be inverted for inside corners, with proprietary non-marking cups featuring FTS™ (Flexible Triple Seal) technology that locks-in vacuum and provides optimum hold—even on textured and leathered materials. Not recommended for porous surfaces or heavy waterfall pieces.

- Consistently create high-quality, expertly aligned perpendicular seams
- Ideal for mitered aprons, butt-joints, compound corners & inside corners
- Proprietary, non-marking vacuum cups won't stain surfaces
- FTS™ vacuum cup technology for optimum hold on textured and leathered materials
- Knurled rollers and fine-tune levelers align and dial-in precise angles
- Counter-pressure leveler overcomes lower outswing of vertical pieces
- Easy to read indicators allow you to monitor vacuum pressure at a glance
- Cups can be re-pumped without loss of remaining pressure

Stock No.	Description	Price
350313	Stealth Seamer 90° Manual.....	\$375.00



Stealth Seamer 90° Automatic

For producing waterfall edges, mitered aprons, butt-joints, and compound corners. Can be inverted for inside corners. Proprietary non-marking cups feature our FTS™ technology that locks-in vacuum for optimum hold.

- Create high-quality, expertly aligned perpendicular seams
- Knurled rollers and fine-tune levelers help align and dial-in precise angles
- Counter-pressure leveler overcomes lower outswing of vertical pieces
- Powerful, compact pump maintains max pressure for entire system
- Uses AC power or AA batteries for any situation

Stock No.	Description	Price
350312	Stealth Seamer 90° Manual..... (Pair with toolbox)	\$1,495.00



Pro Stealth Seamers

Great for completing a "seamless" installation, the Pro Stealth Seamer joins, levels, and flattens warped stone for producing virtually invisible seams. It's accessible design allows you to view the seam, make adjustments, apply epoxy, and scrape the seam while it's in use, speeding up the process.

- Gray, non-marking vacuum cups won't stain lighter colored materials
- Joins, levels, and flattens warped stone
- Manual thumb pump of our own patent-pending design
- Improved vacuum-release valve is very resistant to epoxy and solvents

Stock No.	Description	Price
350318	Pro Stealth Seamer Auto, Set w/8" Cups.....	\$1,199.00
350319	Pro Stealth Seamer Manual, Single Unit w/8" Cups.....	425.00

Omni Cubed® Rigid Cross-Brace Kit For All Sink-Hole Savers

The Rigid Cross-Brace kit for all Sink Hole Savers provides a solution for large-format porcelain tile transport and installation. The Rigid Cross-Brace Kit is an accessory for vacuum Sink Hole Savers that includes two 4' strengthening bars and four clamps, so your customers can put together custom frameworks that can be configured for a variety of applications. An optional Horizontal Lifting Handle Kit is also available, which provides a gripping point beyond the ends of the bars.

- Minimizes twisting and flexing of material
- Sturdier than using unconnected bars or rails
- Works great for LFT (large format tiles)
- Create custom configurations
- Integrated "resting" feet won't scratch surfaces when material is inverted

Stock No.	Description	Price
350114	Rigid Cross-Brace Kit for All Sink Hole Savers...	\$550.00
350115	Horizontal Handle Kit for Cross-Brace.....	85.00



#350115 Horizontal Handle Kit



Gorilla Grip Seam Setter 2.1

The Gorilla Grip system provides fast and powerful clamping of stone surfaces using an electric vacuum pump. Seams can be rapidly opened or closed by simply moving the roller nut with the palm of your hand. The vacuum pump ensures consistent and powerful clamping of the pods to the work surface. Works well with polished or porous stone.

- Powerful Clamping Mechanism
- Effectively Aligns Heavy Stone Tops
- Electric Vacuum Pump Holds Tight
- Easy To Use

Gorilla Grip 2.1 #133426



Gorilla Grip Original with Cams #133421

Stock No.	Description	Price
133421	Gorilla Grip Original w/Cams.....	\$1,099.00
133426	Gorilla Grip 2.1.....	1,199.00
133423	Gorilla Grip S-Hook Cams Set (4).....	39.95
133424	Complete Gasket & Filter Replacement Kit.....	49.95
102717	Control Valve, Exhaust Bleeder on Right.....	13.50
133440	Replacement 5" Jumper Hoses (Red, 4 Pcs.).....	12.95
133441	Replacement Coiled Hose (Blue, 1 Pc.).....	10.95
133442	Replacement Quick-Connect, Straight (4 Pcs.).....	20.95
133443	Replacement Elbow 1/8" NPT (2 Pcs.).....	18.95
133444	Replacement Pump.....	347.79

Gorilla Grip Waterfall Clamp Accessory

Designed to clamp full length waterfall pieces that go all the way to the floor when attached to a standard Gorilla Grip Vacuum system and standard "scissor" clamps (not included). Includes two 20" long stainless steel "T" shaped metal clamp accessories for producing 90° waterfalls.

- Economical Waterfall Clamp system for fabricators who already own a Gorilla Grip vacuum system and scissor clamps (or purchase separately)
- Simple method for producing 90° waterfalls
- Requires Gorilla Grip Vacuum System

Stock No.	Description	Price
133422	Waterfall Clamp Accessory (2 Pieces).....	\$89.95

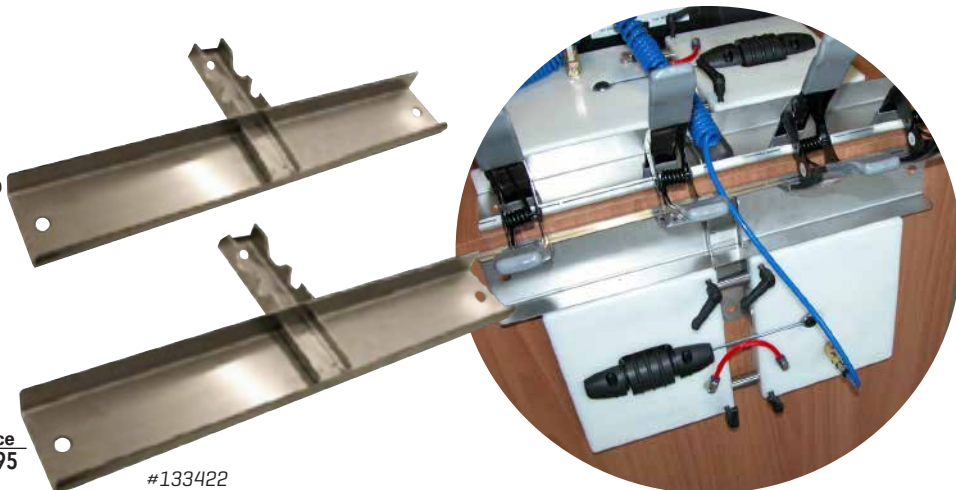

#133422

Produce consistently high quality "waterfalls" using the Gorilla Grip Waterfall Clamp accessory, Gorilla Grip seam setter and standard scissor clamps.



Stone Pro SR2 Vacuum Support Rail System

Each SR2 rail has 4 adjustable suction cups connected in a series for maximum holding power, even on textured surfaces.

- Vacuum pods work great on textured or polished surfaces
- Alkaline 12 volt power supply for longer run time
- Easy access relief valve for quick evacuation and removal

Stock No.	Description	Price
500136	Single Rail.....	\$598.00



Stone Counter Top Cup Support System

Versatile design; safely and efficiently lift, transport, position and set countertops using combined clamping power of 12 suction cups with aluminum support rails.

- Two 7' aluminum support rails & 12 suction cups
- Rails brace countertops for less breakage easy lifting.
- Rails are non-slip cork padded to protect your finish.

Stock No.	Description	Price
500025	Support System.....	\$412.00
500042	7' Replacement Rail.....	113.00
500027	4.6" Replacement Dual Suction Cups...	21.95



Top Saver™ Rail System

The Top Saver System's simple design allows counter tops to be stacked side by side without the use of bulky C-clamps or protruding crank downs.

- No costly parts to wear out or replace
- Keep fastened throughout the fabrication process
- Carry tops easily without the danger of broken sink rails

Stock No	Description	Price
500130	6' pair/3 cm.....	\$311.00
500131	6' single rail/3 cm.....	179.50

VACUUM CUPS/SEAM SETTING



**Pro Series®
Seam Setter**

Positions countertops horizontally & vertically. Two dual action ratcheting handles: for horizontal adjustments in both PUSH and PULL directions to tighten or loosen joint with two leveling points.

Stock No.	Price
750117	\$317.00



GranQuartz
DIAREX®

**Diarex®
Ratchet Seam Setter**

Positions seams horizontally in pull direction

- 4.6" diameter cups
- Lightweight aluminum body

Stock No.	Price
500028	\$72.40

**Aardwolf
Heavy Duty
Dual Ratchet
Seam Setter**



- 2 leveling points
- Adjusts both horizontally & vertically
- Includes two 8" diameter suction cups

Stock No.	Price
750116	\$331.00



GranQuartz
DIAREX®

**Diarex®
Backsplash
Positioning Tool**

- 4.6" diameter cup
- Lightweight aluminum body

Stock No.	Price
500062	\$68.25

**Abaco Ratcheting
Seam Setters**

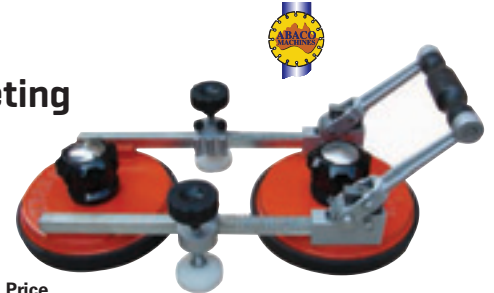

Provide a quick and easy solution for accurate and safe positioning of countertops.

Stock No.	Price
692668	\$352.99



\$57.75
116497

**Woods 8" Vacuum
Cup-ABS Handle
N4000**

- 125 lb. capacity per cup
- Vacuum leakage indicator with suction quick release button
- Includes protective carrying case



\$86.50 116502

**Woods 8" Vacuum
Cup-Metal Handle**

- 125 lb. capacity per cup
- Vacuum leakage indicator with suction quick release button
- Includes protective carrying case



\$97.50
116500

**Woods 9" Vacuum
Cup-Metal Handle**

- Increased capacity for heavy-duty installation with all-metal handle/pump assembly.
- 150 lb. capacity per cup
- Vacuum leakage indicator with suction quick release button
- Includes protective carrying case



\$108.10
116499

**Woods 10" Vacuum
Cup-Metal Handle**

- All-metal handle/pump assembly with concave pad for curved surfaces.
- 175 lb. capacity per cup
- Vacuum leakage indicator with suction quick release button
- Includes protective carrying case



\$52.50
500033

Diarex® 8" Vacuum Suction Lifter, ABS Handle

Lightweight and economical with rust-resistant parts.

- 125 lb. capacity per cup
- Vacuum leakage indicator with suction quick release button
- Includes protective carrying case



Diarex® Gray Rubber Non-Marking Vacuum Suction Lifters

Designed with a light gray composite rubber to prevent any marking of lighter colored materials.

- 125 lb. capacity per cup
- Vacuum leakage indicator with suction quick release button
- Includes protective carrying case



Stock No.	Description	Price
102515 ...	8" Diam., Plastic Handle.....	\$78.95
102516 ...	10" Diam., Metal Handle.....	117.55



\$87.95
500064

Diarex® 10" Vacuum Suction Lifter, Metal Handle

10" Diameter lightweight and economical vacuum cup with rust-resistant parts.

- 175 lb. capacity per cup
- Vacuum leakage indicator with suction quick release button
- Includes protective carrying case



\$75.55
500032

Diarex® 8" Vacuum Suction Lifter, Metal Handle

Built for heavy-duty installation with all-metal handle/pump assembly.

- 125 lb. capacity per cup
- Vacuum leakage indicator with suction quick release button
- Includes protective carrying case



\$93.45
500063

Diarex® 10" Vacuum Suction Lifter, Metal Handle

Built for heavy-duty installation with all-metal handle/pump assembly.

- 175 lb. capacity per cup
- Vacuum leakage indicator with suction quick release button
- Includes protective carrying case



\$83.95
500065

Diarex® 9" Vacuum Suction Lifter, Metal Handle

Lightweight and economical vacuum cup with rust-resistant parts.

- 150 lb. capacity per cup
- Vacuum leakage indicator with suction quick release button
- Includes protective carrying case

Nemo® Grabo Battery Powered Vacuum Cup

Battery powered hand held suction cup features a built-in vacuum gauge & comes in a hard shell case with a back up battery, carry strap, replacement foam ring, charger, and replacement filter.

- 200 lb. capacity, polished granite
- Includes back up battery



Stock No.	Description	Price
101125 ...	Nemo Grabo Vac. Cup.....	\$249.00

Diarex® Three-Position 8" Vacuum Cup

Three position handle locks into place for lifting applications.

- 286 lb. capacity per cup
- Center knob tightens to secure vacuum cup

\$78.70
500029



Diarex® Inline 7" Suction Cup

Metal inline design, heavy duty all metal handle and pump assembly.

- Rugged cast metal grip with vertically positioned pump
- Vacuum leak indicator
- Quick suction release button
- 170 lb. capacity

\$62.95
500068



Diarex® Aluminum Double Suction Cup

All aluminum body with center handle for easy lifting. Great for using with the Diarex Countertop Transport System, #500025.

- Lightweight aluminum body
- 176 lb. capacity
- 4.6" diameter x 12.75" length

\$21.95
500027



Shown with the Diarex Countertop Transport System, #500025



\$14.95
500024

Diarex® Single Action Suction Cup

Suction is created by single handedly pulling handles together. When handles are released, suction is lost.

- Lightweight aluminum body
- 110 lb. capacity per cup
- 4.8" diameter



#114700 - 50/50 Double Bowl
18 Gauge Stainless Steel Kitchen Sink
\$99.95



#114701 - 60/40 Double Bowl
18 Gauge Stainless Steel Kitchen Sink
\$99.95



#114702 - 60/40 Reverse Double Bowl
18 Gauge Stainless Steel Kitchen Sink
\$99.95



#114704 - Single "D" Bowl
18 Gauge Stainless Steel Kitchen Sink
\$79.95



#114703 - Single Bowl, 29x16x9"
18 Gauge Stainless Steel Kitchen Sink
\$99.95



#114705 - Single Bowl, 21x15 1/2 x 9"
18 Gauge Stainless Steel Kitchen Sink
\$79.95



Improved Packaging for Clear Identification

Oliveto Porcelain Vanities are available individually or in pallets of 40.

Note: \$5 Shipping and Handling Fee Added for Less than Pallet Quantities.

Call For Pricing

OLIVETO™



#869188 - White Porcelain Oval Sink
White Undermount Porcelain Vanity Sink.
Bowl Measurements: 14 3/4" x 11 3/4"



#869189 - White Porcelain Oval Sink
White Undermount Porcelain Vanity Sink.
Bowl Measurements: 15 1/8" x 12 1/8"



#869191 - White Porcelain Oval Sink
White Undermount Porcelain Vanity Sink.
Bowl Measurements: 17 1/2" x 14 3/8"



#869192 - White Porcelain Rectangular Sink
White Undermount Porcelain Vanity Sink.
Bowl Measurements: 16" x 11"



#869186 - White Porcelain Rectangular Sink
White Undermount Porcelain Vanity Sink.
Bowl Measurements: 18 5/8" x 11 3/8"



#869193 - White Porcelain Rectangular Sink
White Undermount Porcelain Vanity Sink.
Bowl Measurements: 18" x 13"

OLIVETO™



Oliveto Tight Radius 18 Gauge Stainless Steel Sink

Oliveto's tight radius (R22) sink is as practical as it is contemporary. Straight lines make for faster sink cutouts, fabrication and polishing and your customers will have an attractive, precision crafted product when installation is complete.

Stock No.	Description	Price
114367	50/50 Double	\$138.95



Revere stainless steel sinks are made from 300-series steel, complete with sound-dampening pads and a full spray undercoating. Brushed satin finish with 3 1/2" drain openings. 16 and 18 gauge steel options are available.

Call For Pricing

Description	Price
Stainless Steel UM Sinks, 18GA:	
SINGLE "D" SHAPE (23X21).....	CALL FOR PRICE
60/40 "D" SHAPE (8x8).....	CALL FOR PRICE
40/60 "D" SHAPE (8x8).....	CALL FOR PRICE
SINGLE BOWL (21X15)	CALL FOR PRICE
50/50 EQUAL (31X18)	CALL FOR PRICE
60/40 SQUARE (10x8)	CALL FOR PRICE
40/60 SQUARE (8x10)	CALL FOR PRICE
SINGLE BOWL (26x18).....	CALL FOR PRICE

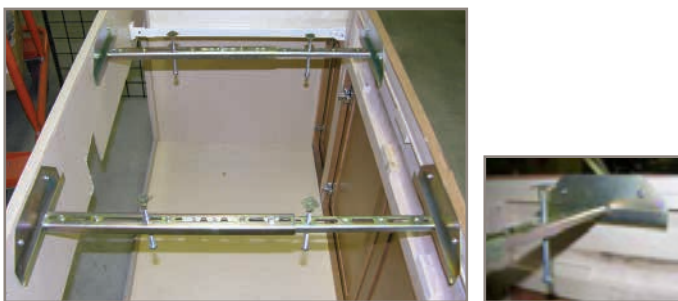

Diarex® EZ Sink Setters

- Easily undermount almost any sink
- Set includes two telescoping rails
- No cutting required to fit cabinet depths of 20"—26"

Stock No.	Adjustable Sink Setter Description	Price Each (Qty. 1-49)	Price Each (Qty. 50+)
340323	Front to Back 14"-26", PW-99P	\$22.70	\$20.65
340324	Side to Side 25"-47", PW-104P	28.45	26.85
340325	Original, Front to Back 14"-26", PW-99	22.70	20.65
340328	Side to Side w/ offset 31"-47", PW-114P	32.99	30.95

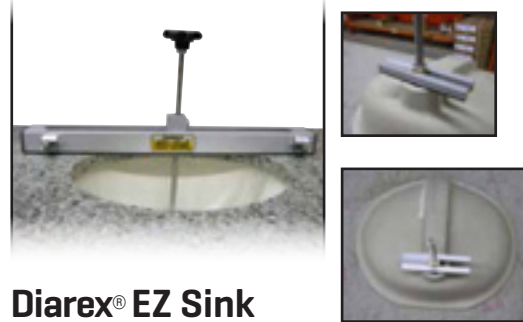

Diarex® EZ Sink Installation Tool

Quickly position sinks with this slotted aluminum frame cushioned with rubber to protect surfaces.

- Available in single sink or double sink sizes
- Holds sinks in place for undermount installations
- Undersink clamp has EZ release button to easily slide into place and lock firmly.
- 22 1/2" threaded rod for easy adjustment

Stock No.	Description	Price
912147	24" Single Hanger	\$79.95
912148	42" Double Hanger	129.95

Sink Undermounters

- Choose 25, 36 and 50" lengths trim to fit any cabinet size
- Eliminates the need for wood support
- Includes 2 rails, 4 mounting clips, 8 adjusting bolts/nuts, 2 joiner clips
- Sink Overflow Clips accessory: allows support for bowls with overflows with 2 sets of sink undermounters (includes 2 sliding clips, 2 adjusting bolts/nuts)



Stock No.	Length	Price/Each (Qty. 1-49)	Price/Each (Qty. 50+)
340190	25"	\$22.15	\$19.43
340192	36"	26.85	22.94
340193	50"	41.25	35.99

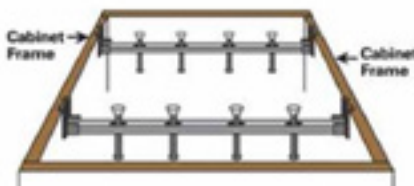

Undermount Sink Installation Clamps

Undermount sink clamps allow sinks to be placed before silicone begins to set-up.

- Rubberized bar protects sink surfaces

Stock No.	Description	Price
103708	Sink Clamps, PAIR	\$61.95



Granite Grabbers™ Dishwasher Mounting Brackets

- Fast, secure mounting
- Includes 2 steel brackets with permanent adhesive backing and screws

Stock No.	Desc.	Price
340336	2 Pack	\$5.15



Sinkits® E-Brackets

E-Brackets require no drilling, slotting or adhesives and hang over the cabinet divider for added strength.

- Adjustable for all installations
- Only one screw needed to hold them in place

Stock No.	Description	Price
340421	E-Brackets, Box of 32	\$44.55



Sinkits® LC Brackets

Sinkits LC (Low Clearance) Bracket is used when there is no room for conventional clips or clamps.

- Great for supporting fallen sinks
- Sold in pairs or in case of 72 (36 sets)

Stock No.	Description	Price
340334	LC Brackets, Pair	\$3.98
340334	Case of 72 Pairs	268.56



Ultra Fast Ratchet Sink Bracket System

Ultra Fast is the fastest sink installation system because it's only ONE step. Available in clip on or threaded screw on version. Clip On version fits 3/8"-5/8" thick cabinet walls and has hammer-in clips. Threaded version simply screws in place, Ultra-Fast!

- Self contained system, no small parts to lose
- Grade-8 high strength carbon spring steel clip bolts
- Repair clips are also available for sink repairs

Stock No.	Description	Price
364876	Clip On, Long Arm	\$6.20
364877	Clip On, Short Arm	6.20
364870	Screw On, Long Arm	5.59
364871	Screw On, Short Arm	5.59
364872	Repair Clip	4.20

Sinkits® Undermount Sink Anchors

Sinkits mechanical anchors are designed to be used in 2cm & 3cm stone countertops, via holes drilled on the underside of surface. Very strong, supports up to 117 pounds each!

- Fast and easy to use
- Time saving



#102913



#340339



GoClips Sink Clips

Innovative new design in steel sink mounting clips. All you need is a grinder and a diamond blade for professional, consistent results.

- Self-locking with spring clip
- Use on sink rims up to 3/4"
- Time saving

Stock No.	Description	Price
340339	Sinkits Anchors, 48Pcs.....	\$66.95
150501	Sinkits Anchors, 350Pack.....	424.88
340241	Sinkits Undermount Clips 3/4" Stud, 48 Ct.....	65.85
340341	Sinkits Undermount Clips 1 1/2" Stud, 42 Ct.....	53.74
364879	Sinkits with 1 1/2" Bolt, 300 Ct.....	369.99
340407	High Rise Clips, Max 1 3/8" Sink Rim, 40 Ct.....	71.55
102913	Sinkits Slot Klips, 45 Ct.....	59.00
102912	Sinkits Slot Klips, Bulk Pack, 325 Ct.....	445.00

Stock No.	Description	Price
069100 Pack of 25, Standard.....	\$35.95
063364 Pack of 50, for Stainless Steel.....	49.79
063365 Pack of 20, XL for Porcelain.....	25.50
063366 Pack of 25, HD Dual Use, Standard.....	31.00
063367 Pack of 20, HD Dual Use XL.....	28.40
104422 Pack of 50, HD Stainless Steel.....	52.79

Cincliips® Undermount Sink Set

Cincliips undermount sink mounting brackets are the best way to secure an undermount sink. Simply screw into the cabinet and wedge up under the sink.

- No special glue or epoxy needed
- Kit includes 5 braces w/all necessary hardware for installation
- Easily mounted to the inside of the cabinet



Stock No.	Description	Price
940422 Cincliips Set.....	\$20.95

Pulsar Sink Strap

Pulsar undermount sink straps are a simple way to secure an undermount sink. Just strap on one under the sink and tighten up for a secure hold.

- No special glue or epoxy needed
- Includes 1 strap w/all necessary hardware for installation
- Easily mounted to the inside of the cabinet



Stock No.	Description	Price
448014 Sink Strap w/Hardware ..	\$5.25



E-Z Sink Bracket

- Makes any sink installation a breeze
- Accommodates virtually any under-counter sink type
- Adjustable support rails
- Sold in pairs



Stock No.	Price
940419\$8.95/Pair

E-Z Dishwasher Bracket™



- Made in USA from 22 gauge galvanized steel
- Available in 26 1/2" or 18" length
- Easy installation under any type of counter top
- Can be installed prior to or after counter top installation
- Dishwasher does not have to be present at jobsite

Stock No.	Description	Price
940413 26 1/2" Metal bracket.....	\$4.45
940421 18" Metal bracket.....	4.45



Diarex® Adhesive Bonded Anchoring System

No-drill steel anchors adhere to underside of counter tops for secure sink installations.

- Packs of 6 pcs. and cases of 16 packs of 6 pcs.



Stock No.	Description	Price/Case
940407\$8.61/pack.....	\$90.95



Diarex® Undermount Sink Clips

Stock No.	Description	Price
94041725 pcs. pack.....	\$14.82



Diarex® Undermount Sink Clips

Stock No.	Description	Price
9404046 pcs. pack.....	\$4.50



Diarex® #2 Sink Clip Adapter

Stock No.	Description	Price
93332725 pcs. pack.....	\$48.62



Diarex® Adhesive Bonded Dishwasher Anchors

Stock No.	Description	Price
9404086 pcs. pack.....	\$6.13

GranQuartz
DIAREX®



Diarex® Sink Anchors, Clips & Screws

Closed-end 10/24 thread anchors

Stock No.	Description	Price
940403	Anchors/100 pcs.....	\$16.03
940412	10/24 Screw.....	6.16
	1/2", 100 Per Pack	
940411	10/24 Screw.....	6.16
	3/4", 80 Per Pack	



Rectangular Dishwasher Mounts

Stainless steel self-nutted mounts with bolts.

- 25 Pack
- Stainless steel
- Six holes

Stock No.	Description	Price
698359	Steel mounts/25 pack.....	\$18.99

Diamond Grip II and TSN Installation Tool

Lever action tool provides maximum setting power with minimum effort. Operating instructions included.

- Drill hole & insert mounting nuts for simple sink setting
- No adhesives needed
- 1/4" Blind hole bit



Stock No.	Description	Price
364829	Diamond Grip Install Tool.....	\$130.65
364830	DG II TSN Conversion Kit.....	59.37
364845	Mounting Nut Inserts, 25 pk.....	12.95
364856	1/2" Diamond Grip Screws, 100 pk.....	6.67
364857	3/4" Diamond Grip Screws, 100 pk.....	7.75



Adjustable Brace Setter

Features the same high-performance router housing that connects to a 5/8 x 11 angle grinder to quickly cut a precise 2 9/16" wide groove for your brace, with an added bonus.

Adjustable- allows you to adjust the cutting depth from 0 to 3/8. By turning the blue top of the Brace Setter Adjustable, you can move the blades up or down to make a precise groove at any depth required. Has more cutting power with 3 cutting blades instead of 2, for a total of 54 long-lasting tungsten carbide teeth.

Stock No.	Description	Price
100764	Brace Setter Adjustable (from 0 – 3/8").....	\$278.75
100767	Brace Setter Adjustable replacement blade set.....	70.65
187375	Brace Setter replacement handle.....	9.55

Counter Balance Installation Braces

For installations to support overhangs on stone and solid surface countertops. Low profile brackets are hidden from view offering a clean, modern look.

- Made with 7GA, HRPO Steel
- Island bar supports 18" overhang
- Counterplate supports 13" overhang, Counterplate XL supports 15" overhang
- CrossBar supports 18" overhang in two directions



Island Bar



CounterPlate XL



CounterPlate

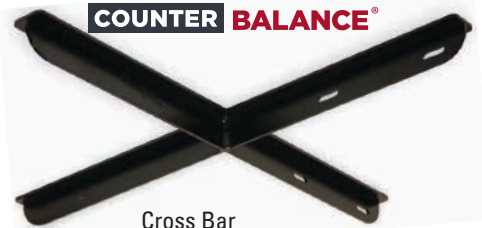

Cross Bar

Stock No.	Description	Price
364911	Bar, 24"L x 1.75"W x 1.75", 3-Pack.....	\$74.95
364922	Mini-Bar, 20"L x 1.75"W x 3/16", 3-Pack.....	64.95
364912	Counter Plate, 9.75"L x 3.75"W x 3/16", 3-Pack.....	34.95
364913	XL Plate, 11.75"L x 3.75"W x 3/16", 3-Pack.....	43.90
364916	Crossbar, 24"L x 1.75"W, 1-Pack.....	74.95

Stone Braces

Stone Braces are for supporting stone overhangs and should be placed at about 18"-24" centers (varies depending on the type and strength of the stone.) New design features powder coated finish and beveled corners for safer handling by installer and a more professional look.



Stock No.	Description	Price
382508	13"L x 2.5"W x 3/16" Thick.....	\$12.53
382509	20"L x 2.5"W x 3/16" Thick.....	17.09
382510	10"L x 2.5"W x 1/4" Thick.....	13.67
382511	15"L x 2.5"W x 1/4" Thick.....	17.09
382514	10"L x 2.5"W x 1/4" Thick, L-shape.....	18.23
382515	15"L x 2.5"W x 1/4" Thick, L-shape.....	22.79

Nelson Standard Wood Shims

- 8" Pine shims
- 120 shims in a box

Stock No.	Price
340311.....	\$11.85/Box



Composite Wood Shims

- Mold and mildew resistant
- Will never decay
- Easy and clean snap
- Sold in boxes of 32 bundles (12 shims per bundle)

Stock No.	Description	Price
698212	12/BDL - 32BDLS/BOX	\$91.25
340301	5" Pre-Scored 12/BDL	2.90
364885	8" Pre-Scored 32/BOX	7.39

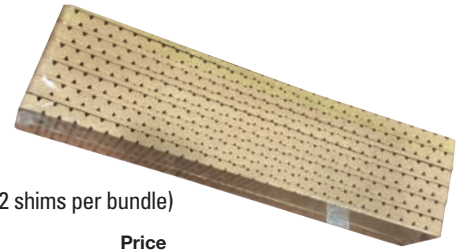

Tapered Plastic Wedges

- Standard tapered wedge (1 1/2" x 3 3/8") tapers from 1/32" to 1/4"

Stock No.	Description	Price
100209	Standard Wedge, 100 ct.	\$17.30
100207	Standard Wedge, 1,000 ct.	152.90



Tapered Snap-Break Plastic Wedges

- Breakaway wedge (1 1/2" x 6") tapers from 1/32" to 3/8", scored in 1" segments

Stock No.	Description	Price
100210	Breakaway Wedge, 100 ct.	\$61.90
100208	Breakaway Wedge, 600 ct.	363.80



GranQuartz
DIAREX®

Diarex® Stone Wedges

Ultra durable nylon ribbed wedges, available in containers of 75 or 300 pieces.

Stock No.	Box Qty.	Price
340320	300	\$46.39
340321	75	15.11

GranQuartz
DIAREX®



Diarex® Horseshoe Leveling Shims

- Available in 1/16", 1/8" or 1/4" thicknesses
- Available in boxes of 100 or 1,000

Stock No.	Thickness	Color	Qty.	Price
100191	1/16"	Blue	100	\$3.10
100192	1/8"	Red	100	4.20
100193	1/4"	Black	100	7.35
340300	1/16"	Blue	1000	16.25
340305	1/8"	Red	1000	31.45
340310	1/4"	Black	1000	50.40



Weg-Fab® Fabricator's Wedges

Fabricator's leveling wedges, available in packages of 50 pieces.

- Strong & durable polystyrene material
- Deeply embossed score line at top allows separation if required

Stock No.	Pkg. Qty.	Price
698668	50	\$7.35

NSI Solutions® Twist Shims

Simple design makes countertop installations and repairs faster and more cost effective.

- Use for situations that are difficult to shim and apply adhesive
- Use where access is limited- accurately level and inject adhesive from underneath
- Can be used in sub-tops or corner blocks
- Use to pre-level seams
- Perfect for Lazy Susans
- Can be installed before or after the stone is in place
- Shims are .9" tall

Stock No.	Description	Price
790445	Twist Shim Driver.....	\$19.50
790446	Twist Shims, Container of 50	49.00
790447	Twist Shims, Container of 200.....	179.00



Twist Shim
#790446



Twist Shim Driver
#790445

Twist Shims are fast, easy to use and save time and money on countertop installations.



1 Drive Twist Shim through 5/8" pilot holes, drilled at user specified locations



2 Level- Place countertop on cabinet & adjust level from underside with ratchet & shim driver



3 Glue- Apply adhesive through center hole of Twist Shim to permanently lock counter in place

Awarded
StonExpo
Best of 2015
Innovation



Cooktop Bags

This simple innovation helps you virtually eliminate the mess of stone debris and dust during cooktop installations while protecting the insides of the cabinets, hinges and drawer slides. Water and stone debris that would otherwise drop into the cabinet during installation is safely secured inside the cooktop bag! Installers can save 15-20 minutes PER JOB using this product.



- Made from 1.5 Mil clear poly
- Accommodates all cooktop cutouts & cabinets between 30" - 36" L x 24" W
- Dispenses from roll of 25
- Easy to use, wet or dry
- Virtually eliminates mess of dust and debris
- Helps prevent damage to cabinetry and drawer slides during installation



Stock No.	Description	Price
101105	1.5 Mil Poly Cooktop Bags	\$37.93

Countertop Protective Film

- Great for natural stone & engineered surfaces
- Protects seams & grout lines
- Scratch resistant
- Adhesive backed

Stock No.	Description	Price
340168	24" x 600' 1.5 Mil* Clear Film	\$57.70
340169	24" x 600' 1.5 Mil* Blue Film	57.70
340115	24" x 600' 2.5 Mil* Clear Film	103.99
447913	24" x 600' 2.5 Mil* Blue Film	103.99
698444	30" x 600' 2.5 Mil* Clear Film	109.99
698445	30" x 600' 2.5 Mil* White Film	109.99
340146	30" x 600' 3.5 Mil* Clear Film	136.50

*Mil thicknesses are nominal



Diarex® Resin Filler Sticks

- Sold in boxes of 12 or individually
- Great for touch-ups on marble or granite
- Available in 12 colors & assortment pack

GranQuartz®
DIAREX®



Stock No.	Color	Price /Box	Price Each	Stock No.	Color	Price /Box	Price Each
340054	White.....	\$51.30	\$4.75	340103	Chocolate.....	\$51.30	\$4.75
340056	Black.....	51.30	4.75	340107	Yellow Ochre.....	51.30	4.75
340053	Transparent.....	51.30	4.75	340102	Med. Brown.....	51.30	4.75
340101	Cream.....	51.30	4.75	340111	Tan.....	51.30	4.75
340106	Green.....	51.30	4.75	340112	Light Brown.....	51.30	4.75
340108	Deep Gold.....	51.30	4.75	340109	Multicolor Pack.....	38.75	n/a
340104	Nat.Transp.....	51.30	4.75				

TRIMACO

Builder's Paper

Paper "drop cloth" for protecting work surfaces from scratches, paint or debris during fabrication/installation.

Stock No.	Description	Price
34013935" x 140" Roll.....	\$11.50



GranQuartz®
DIAREX®



Diarex® Quick-Set Anchor Adhesives Acrylic or Epoxy

Works great with our adhesive bonded anchors & adhesive bonded dishwasher anchors.

Stock No.	Description	Price
900775	Acrylic 25ml Cartridge.....	\$10.95
900776	Acrylic 50ml Cartridge.....	13.55
900777	Epoxy 25ml Cartridge	8.15
900778	Epoxy 50ml Cartridge	15.05
900779	50ml Static Mixing Tip	1.00
900396	50ml Dispensing Gun/W/Plunger.....	22.85

Pre-Taped Plastic Drop Cloth

Built-in static cling helps the plastic drape cling to the surface protected - even in windy conditions or with spray applicators.

Stock No.	Description	Price
3401272' W x 90' L Roll	\$7.35
3401283.94' W x 72' L Roll.....	9.80
4479242' W x 100' L Roll	6.75





GranQuartz
DIAREX®

**Diarex®
Fiberglass Rod Dispenser**
Support rods in 328 ft. roll, (stock #118012).

Stock No.	Price
118011.....	\$310.00



**Weha®
Carbon Fiber Rodding**

The latest technology in fiberglass rodding for granite, all natural stones, engineered stones, and quartz counter top applications.

- Sold in 328' L x 3/8" W x 1/8" Thick roll

Stock No.	Description	Price
052144	328' Roll.....	\$132.60



GranQuartz
DIAREX®

**Diarex®
Low Profile Fiberglass
Support Rodding**

Designed for 2cm material applications, lower profile rodding allows for complete coverage without grinding excess adhesive.

- Sold in 328' L x 1/4" W x 1/8" Thick roll

Stock No.	Description	Price
118216	328' Roll.....	\$170.94

GranQuartz
DIAREX®



(118010)

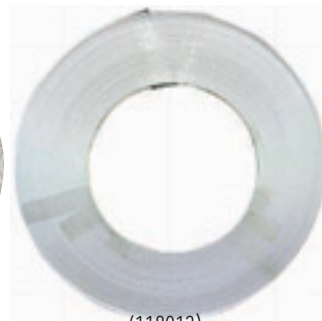

(118012)

**Diarex®
Fiberglass Support Rodding**

- Fiberglass rods, 1/8" x 3/8" x 13 Ft
- Sold separately or in bundles of 10

Stock No.	Description	Price	Price
118010	13' L x 3/8" W Rods.....	\$11.73/ea.....	\$72.35/bundle

Stock No.	Description	Price
118012	328' L x 3/8" Roll	\$193.74



(#382501)



(#382502)



(#382503)



(#382504)
(#382505)



(#382506)



DuBois Carvings® Wood Corbels

Wood corbels are CNC machined for exact pattern duplication, and hand carved for finishing details. Every Du Bois® wood corbel is then hand sanded, UPC labeled, shrink-wrapped, and packed with a silica bag for moisture protection.

Stock No.	Dimensions	Wood Type	Price
382501	3" x 6-1/2" x 12"	Rubberwood.....	\$17.14
382502	3" x 6-1/2" x 12"	White Birch.....	16.65
382503	2-5/8" x 9" x 13-1/8"	Rubberwood.....	42.34
382504	3" x 7-5/8" x 10-1/2"	Rubberwood.....	24.09
382505	2" x 7-1/2" x 10-1/2"	Rubberwood.....	24.09
382506	1-1/2" x 10" x 13-1/2"	Antique Copper.....	52.55

TUSCAN® TrueSpace SeamClip™ System



Tuscan TrueSpace is the latest development for lippage free tile installation on walls & floors. TrueSpace SeamClips are 1-piece spacers that are easy to use with no tools required!

- Easy to use, for gauged tile 3/8" to less than 1/2" thick
- No tools needed
- Eliminates lippage
- Creates grout joint, available in 4 widths

Stock No.	TrueSpace SeamClip Description	Price
677810	Qty: 150- 1/16", Orange.....	\$44.61
677811	Qty: 500- 1/16", Orange.....	140.66
677812	Qty: 1,000- 1/16", Orange.....	279.11
677813	Qty: 150- 1/8", Green.....	\$44.61
677814	Qty: 500- 1/8", Green.....	140.66
677815	Qty: 1,000- 1/8", Green.....	279.11
677816	Qty: 150- 3/16", Purple.....	\$44.61
677817	Qty: 500- 3/16", Purple.....	140.66
677818	Qty: 1,000- 3/16", Purple.....	279.11



TUSCAN® SeamClip™ System

Tuscan SeamClips are the latest innovation for lippage free tile installation on walls & floors. SeamClips are 1-piece spacers that are easy to use with no tools required!

- Easy to use
- No tools needed
- Eliminates lippage
- For vertical or horizontal installations

Stock No.	Description	Price
677710	150 SeamClips, Red.....	\$44.62
677711	500 SeamClips, Red.....	140.66
677712	1000 SeamClips, Red.....	279.12
677713	150 SeamClips, White.....	44.62
677714	500 SeamClips, White.....	140.66
677715	1000 SeamClips, White.....	279.12
677716	150 SeamClips, Blue.....	44.62
677717	500 SeamClips, Blue.....	140.66
677718	1000 SeamClips, Blue.....	279.12



Blue SeamClip- for 1/4" to 1/4" thick ceramic tile



Red SeamClip- for gauged tile 3/8"-1/2" thick



White SeamClip- for 1/8" thick large format thin-body ceramic tile & gauged tile up to 1/4" thick



NO TOOLS NEEDED!



FAST, EASY REMOVAL!

TUSCAN® Levelling System

Tuscan Leveling is a unique 2-piece system that virtually eliminates lippage during tile installation. Choose the Standard Strap for tiles of uniform thickness (gauged tile), or the Wing Strap for tiles with varying thickness.

- Passes standard industrial (TCNA Robinson) compression test
- Virtually lippage free, flat surface drastically reduces the need for grinding and polishing
- Prevents tiles from moving while curing
- Choose either Standard (gauged tile) or Wing style (varying thickness tile)
- Reduces installer fatigue/stress.
- Re-usable caps.

Stock No.	Description	Price
700007	200 Straps/Bucket.....	\$50.00
700004	500 Straps/Bucket.....	125.00
700000	1000 Straps/Box.....	199.95
700040	Box of 500 Wing Strap.....	125.00
700041	Box of 1000 Wing Strap.....	199.95
700008	200 Re-usable Caps/Bucket.....	198.00
700005	500 Re-usable Caps/Bucket.....	495.00

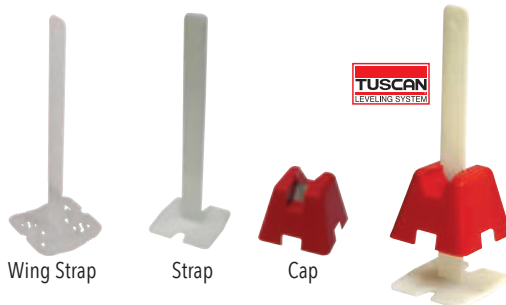

Installation Tools	
700009	Standard Installation Tool..... \$49.95
700019	Ergonomic Performance Tool Kit..... 209.95

Includes: Installation tool, holster and case



PEARL

Pearl® Smart Spacers

GREAT FOR WALL AND FLOOR INSTALLATIONS

Use small (white) Smart Spacers for 1/16", 1/8" or 3/16" applications, use large (black) Smart Spacers for 1/4", 5/16" or 3/8" applications.

- Consistent spacing
- Won't tip or twist like others
- Rigid for consistent wall spacing
- 3 convenient sizes in one
- Installs/removes faster and cleans easier

Stock No.	Description	Price
679040	White, Small (200/pack).....	\$4.99
679041	Black, Large (100/pack).....	4.99

NATURAL STONE & TERRAZZO PRODUCTS



Cyanoacrylate Instant Glues

For use in general countertop repair

Stock No.	Description	Price
900200	Hot Stuff Glue 2 oz., Red Label	\$10.50
900201	Super "T" Glue 2 oz., Yellow Label	10.50
695657	Super "T" Glue 4 oz., Yellow Label	21.95
900202	Special "T" Glue 2 oz., Green Label.....	11.50
900203	NCF Quick Accelerator Aerosol 6 oz.*	12.95
900206	Super Solvent De-bonder 2 oz.....	8.95
900207	Hot Tips LG No-Clog Spouts	1.95
900208	Pro-Tips Ext. Applicators	1.95
900233	NCF Stone Accelerator Aerosol 6 oz.....	21.95
695644	Hot Stuff Pro Kit-1 oz. bottle of each.....	39.95

*Excessive use of accelerator on stone with high concentrations of iron may cause a "green bloom" discoloration.



Grout Sponge

- Hydrophilic grout type
- 7 1/2" x 5 1/8" x 2 1/4"

Stock No.	Price
340121	\$2.25/ea.



Pro Series® Single Edge Razor Blades

Stock No.	Description	Price
340066 100 Per Box.....	\$4.36



Legend® Single Edge Razor Blades

Stock No.	Description	Price
340122 100 Per Box.....	\$5.19

NCF Stone Accelerator

NCF is a stone adhesive accelerator in a convenient aerosol can.

- Formulated for use with "Hot Stuff", "Super T" and other cyanoacrylate instant glues
- Great on lighter colored stone which may be more prone to discoloration
- For use on natural stone and other hard surfaces



Stock No.	Desc.	Price
900233	6 oz. can.....	\$21.95

Spray Bottle

Convenient reusable 32 oz. capacity Handi-Hold spray bottle chemical resistant sprayer.



GranQuartz
DIAREX®

Stock No.	Price
100258\$4.07

Stock No.	Price	
100261	... Replacement trigger	2.50



Rival® Hide A Scratch System

Designed to hide scratches in stone making them virtually undetectable. Avoid having to re-polish stone if you find scratches after buffing or on the jobsite. Save time and money by not having to redo a job. This is a must for every fabricator.

- Apply Scratch Remover, apply accelerator spray and scratch off excess to fill and hide scratches in the surface

Stock No.	Description	Price	Stock No.	Description	Price
358797	Thin, 2 Oz.	\$8.99	358924	Activator Spray, 6Oz.....	\$12.95
358798	Med./Gap Filling, 2 Oz.....	8.99	358922	Activator Spray, 2 Oz.....	6.99
358799	Thick/Gap Filling, 2 Oz.....	8.99	358923	De-Bonder Spray, 2 Oz.....	12.95
358800	Super Thin, 2 Oz.	8.99			



Razor Scraper w/Handle

Stock No.	Description	Price
104423	Razor Scraper.....	\$9.99

Tenax Tefill Chip Repair Kit

Tefill kit by Tenax USA is a dual viscosity stone repair kit that dries in under a minute and leaves a polished finish on stone. Use Tefill 1 for fissures, scratches or chips on horizontal surfaces, Tefill 2 to repair larger chips on both horizontal and vertical surfaces. Use Tefill 3 Activator to create the chemical reaction.

Stock No.	Description	Price	Stock No.	Description	Price
923234	1 Super Flowing Clear 1 lb.	\$61.95	923238	2 Thick Flowing Clear 1 oz.	\$11.95
923235	2 Thick Flowing Clear 1 lb.	61.95	923239	3 Activator 2 oz. Pump Spray.....	11.95
923236	1 Super Flowing Clear 1 oz.	11.95	923240	Chip Repair Kit 2 oz. Each	29.95
923237	1 Super Flowing Clear 2 oz.	11.95			



LAVINA FLOOR PREPARATION EQUIPMENT



Lavina® Planetary Machines

Stock No.	Description	Price
869003	L20NE Elite, 7.5 Hp Planetary Machine...	\$9,990.00
869002	L20E Elite, 4 Hp Planetary Machine.....	8,690.00



Lavina® Propane Grinding Machines

Stock No.	Description	Price
869012	L30GE Elite Propane Machine...\$	19,900.00
869008	L25GE Elite Propane Machine.....	18,490.00



Lavina® 25LE Planetary Machine

Stock No.	Description	Price
869005	25LE Planetary Machine.....	\$14,990.00

3" NATO Wet or Dry Polishing Discs

Superabrasive's Nato resin pads are the market's first choice for a wide variety of soft and hard concrete polishing applications

- Wet or dry use
- Wide channels and a unique patented design allow for work on a cleaner surface, ensuring a quality polish
- Thick 12mm layer of resin and diamonds for extra long life



Stock No.	Grit	Price
400289	30 grit.....	\$19.20
400290	50 grit.....	19.20
400291	100 grit.....	19.20
400292	200 grit.....	19.20
400293	400 grit.....	19.20
400294	600 grit.....	19.20
400295	800 grit.....	19.20
400296	1500 grit.....	19.20
400297	3000 grit.....	19.20

V-Harr® System for Polishing & Restoring Concrete Floors - Velcro Back Row

Developed exclusively for polishing and restoring concrete floors. Also ideal for terrazzo and soft marble floors and can be used on any planetary movement floor polisher.



Stock No.	Size/Grit	Price	Stock No.	Size/Grit	Price
869274	7", 50 grit.....	\$44.00	869286	9", 400 grit.....	59.00
869275	7", 120 grit.....	44.00	869287	9", 600 grit.....	59.00
869276	7", 220 grit.....	44.00	869227	9", 800 grit.....	59.00
869277	7", 400 grit.....	44.00	869288	9", 1800 grit.....	59.00
869278	7", 600 grit.....	44.00	869226	9", 3500 grit.....	59.00
869279	7", 800 grit.....	44.00	869500	9", Buff.....	59.00
869280	7", 1800 grit.....	44.00	600045	13.5", 220 grit.....	74.00
869281	7", 3500 grit.....	44.00	600044	13.5", 400 grit.....	74.00
869282	7", Buff.....	44.00	600046	13.5", 800 grit.....	74.00
869283	9", 50 grit.....	59.00	600047	13.5", 1800 grit.....	74.00
869284	9", 120 grit.....	59.00	600048	13.5", 3500 grit.....	74.00
869285	9", 220 grit.....	59.00	600049	13.5", Buff.....	74.00



Mastercraft MCL17E Quarry

Simple "select-a-weight" (100-195 lb.) range allows you to balance energy needs less than 15 amps, and at 145 rpm, with enhanced torque. The triple planetary gear box (11:1) and 1-1/2 horsepower motor accommodate a variety of drive pads to handle diamond discs (5-point contact) powdered and liquid chemicals, Tynex or steel brushes for concrete, and various other brushes for stripping, scrubbing, and polishing. It even has self-contained or continuous center-feed liquid source alternatives (optional).

Stock No.	Description	Price
447124	Mastercraft MCL17E Quarry	\$1,795.59
447129	Mastercraft 25 Lb. Plastic Weight.....	112.85



Surface Pro® Gold Stone Buffer

Totally enclosed motor units are ideal for the harshest conditions including; dust, moisture, chemicals. Specifically designed for severe duty stone care and concrete work.

- 17" Severe Duty Floor Machine
- 180 Frame, 1-1/2 HP TEFC Dual Capacitor AC Motor (165 RPM)
- 55' 2-Part 12-3 SJTO Hard Service Cord with Twist-Lok Plug
- Triple Planetary Case Hardened Gears 11:1 with Steel Coupler
- 125# Standard Weight with two 25# Removable Weights
- 4 Gallon Solution Tank with internal & external shutoff valves
- 5" Non-Marking Ball Bearing Wheels
- Comfort Grips with Thumb Operated Safety Switch
- UL / CUL-Approved for Safety Assurance
- Non-Marking 360-Degree Wrap Around Bumper
- Corrosion Resistant Surface Treatments
- Assembled in America

Stock No.	Description	Price
119664	Surface Pro® Gold Stone Buffer	\$2,075.00



Surface Pro® Gold Concrete Edge Polisher, 2-Speed

2-speed machines perform heavy duty grinding and honing at the standard 165 rpm speed. With the flip of the conveniently located handle switch, get professional high-gloss buffing results at 300 rpm. You'll double your productivity potential with 2-speed floor machines.

- Extra Heavy Duty 17" 2-Speed Floor Machine
- 66 Frame, 1-1/2 HP DC Rectified 2 Speed Motor (165-300 RPM)
- 55' 2-Part 12-3 SJTO Hard Service Cord with Twist-Lok Plug
- Triple Planetary Case Hardened Gears 11:1 with Steel Coupler
- 113# Standard Weight with one 25# Removable Weight
- 4 Gallon Solution Tank with Internal & External Shut-off Valves
- 5" Non-Marking Ball Bearing Wheels
- Comfort Grips with Thumb Operated Safety Switch
- UL/CUL-Approved for Safety Assurance
- Non-Marking 360-Degree Wrap Around Bumper
- Corrosion Resistant Surface Treatments

Stock No.	Description	Price
119665	Surface Pro® Gold 2-Speed Concrete Edge Polisher	\$2,135.00



Pearl® 17" Pro Buffers

Turbo MAX HD

1-1/2 HP Induction, dual capacitor AC motor and heavy duty planetary head

Turbo MAX HDi

1-1/2 HP Sealed Induction, dual capacitor AC motor and heavy Duty planetary head. Totally enclosed fan-cooled motor keeps out dirt and dust for longer motor life. Ideal for the harshest conditions (dust, moisture, chemicals). Great for sanding applications, stone care and concrete work.

Buffers Features:

- Left or right hand operations
- 3 idle gear box - 175 rpm
- Optimal weight delivers the right resistance against the floor to get the job done better and faster
- 50 ft. heavy duty (14-3) cord with durable spring steel strain relief
- 5" Non-marking PVC bumper prevents marking furniture or walls
- Extremely durable and convenient handle adjustment mechanism is foot operated
- Assembled in the U.S.A.

Stock No.	Description	Price
677201	Turbo MAX HD 1-1/2HP Induction	\$1,198.95
677202	Turbo MAX HDi 1-1/2HP Sealed Induction	1,655.95
264554	Dust Containment System for Buffers.....	130.11
693745	4 Gallon Solution Tank.....	99.95
677260	Horseshoe Weight 14 lbs.....	62.99
677261	Weight Posts (2).....	63.00

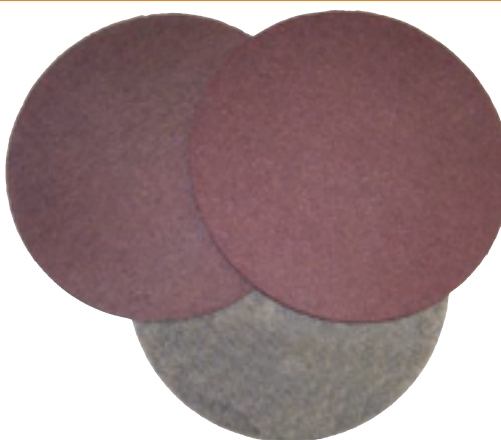

Surface Pro® GOLD VTX DIP Polishing Pad HD

Fastest, most aggressive restoration & polishing of concrete or maintenance of polished floors. Can be used with most topical coats. Wet or Dry use.

Stock No.	Dia.	Color	Grit	Price
400803	17"	Orange	400 Coarse	\$93.00
400604	17"	Gray	800 Medium	93.00
400805	17"	Blue	1500 Medium/Fine	93.00
400807	17"	Red	3000 Fine	93.00
400809	17"	Black	Black - Buff	93.00
400589	20"	Orange	400 Coarse	114.00
400590	20"	Gray	800 Medium	114.00
400591	20"	Blue	1500 Medium/Fine	114.00
400592	20"	Red	3000 Fine	114.00

Stock No.	Dia.	Color	Grit	Price
400594	21"	Orange	400 Coarse	114.00
400595	21"	Gray	800 Medium	114.00
400536	21"	Blue	1500 Medium/Fine	114.00
400537	21"	Red	3000 Fine	114.00
400533	21"	Black	Black - Buff	114.00
400600	27"	Orange	400 Coarse	153.00
400601	27"	Gray	800 Medium	153.00
400602	27"	Blue	1500 Medium/Fine	153.00
400603	27"	Red	3000 Fine	153.00
400534	27"	Black	Black - Buff	153.00



Monkey Polishing Pads

For light restoration & polishing of concrete or maintenance of polished floors. No chemicals required, works best when used wet.

Stock No.	Diameter	Grit	Price
447454	8"	200	\$26.39
447455	8"	400	26.39
447456	8"	800	26.39
447457	8"	1500	26.39
447458	8"	3000	26.39
447459	8"	8000	26.39
447460	8"	11000	26.39

Stock No.	Diameter	Grit	Price
447461	17"	200	\$48.39
447462	17"	400	48.39
447463	17"	800	48.39
447464	17"	1500	48.39
447465	17"	3000	48.39
447466	17"	8000	48.39
447467	17"	11000	48.39

Stock No.	Diameter	Grit	Price
447468	20"	200	\$62.19
447469	20"	400	62.19
447470	20"	800	62.19
447471	20"	1500	62.19
447472	20"	3000	62.19
447473	20"	8000	62.19
447474	20"	11000	62.19

Surface Pro Gold VTX Monroe Dots

Flexible system for grinding, polishing and maintenance of floors. Mounts under existing cleaning/polishing equipment and will not leave resin swirls on the floor. Great for wet polishing of Natural Stone, Concrete and Terrazzo.

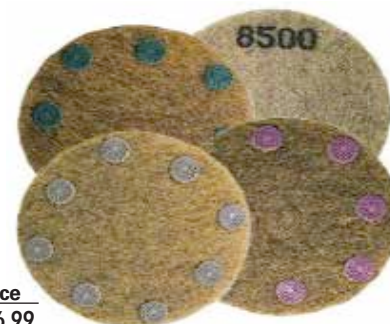

Stock No.	Diam.	Grit	Price
401219	16"	400	\$123.99
401220	16"	800	123.99
401221	16"	1800	123.99
401222	16"	3000	123.99
401223	16"	8500	123.99

Stock No.	Diam.	Grit	Price
401167	17"	400	\$125.99
401168	17"	800	125.99
401169	17"	1800	125.99
401170	17"	3000	125.99
401171	17"	8500	125.99

Stock No.	Diam.	Grit	Price
401162	20"	400	\$196.99
401163	20"	800	196.99
401164	20"	1800	196.99
401165	20"	3000	196.99
401166	20"	8500	196.99



Surface Pro® Gold Buffing Pads

- Packed 5 per case
- Save 10% when buying cases

Stock No.	Color	Diam.	Price Each	Price Per Case
114993	Natural Fiber	8"	n/a	\$13.15
114994	Red	8"	n/a	13.15
114995	White	8"	n/a	13.15
115025	Natural Fiber	17"	5.85	26.33
115028	Red	17"	5.85	26.33
115030	White	17"	5.85	26.33
115029	Tan	17"	5.85	26.33
115024	Black	17"	5.85	26.33
115180	Natural Fiber	21"	8.95	40.28
115181	White	21"	8.95	40.28
115182	Black	21"	8.95	40.28
114983	Natural Fiber	27"	16.88	75.96
115153	White	27"	16.88	75.96
115135	Black	27"	16.88	75.96

Surface Pro® GOLD VTX Foam Adapters

Backer plates to provide firm support to Vortex pads.

Stock No.	Description	Price
400789	17" Foam Adapter	\$127.99
400261	20" Foam Adapter	242.99
401127	21" Foam Adapter	242.99

Please call for other sizes available.

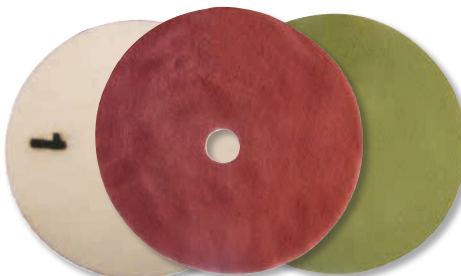

Surface Pro® SELECT Maintenance Pads



Use with auto-scrubbers and burnishers to maintain and increase shine on stone floors. Color coordinated grit sequence. 4 per box but sold individually.

Stock No.	Dia.	Color	Grit	Price
023016	12"	Red	400	\$25.99
023017	12"	White	800	25.99
023018	12"	Yellow	1500	25.99
023019	12"	Green	3000	25.99
023012	16"	Red	400	34.99
023013	16"	White	800	34.99
023014	16"	Yellow	1500	34.99
023015	16"	Green	3000	34.99
023008	17"	Red	400	38.99
023009	17"	White	800	38.99
023010	17"	Yellow	1500	38.99
023011	17"	Green	3000	38.99
023004	20"	Red	400	48.99
023005	20"	White	800	48.99
023006	20"	Yellow	1500	48.99
023007	20"	Green	3000	48.99
023000	27"	Red	400	69.99
023001	27"	White	800	69.99
023002	27"	Yellow	1500	69.99
023003	27"	Green	3000	69.99

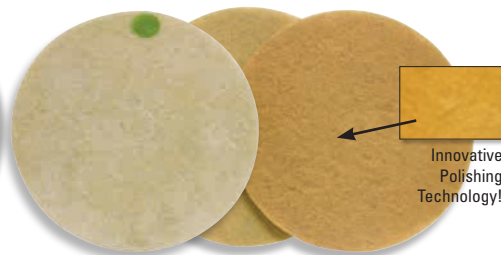

Surface Pro® Gold VTX Maintenance Pads



3-Step System for auto-scrubbers and burnishers to maintain and increase shine.

- Other sizes available, call for special order

Stock No.	Desc.	Color	Price
400881	12" Step 1	White	\$37.99
400882	12" Step 2	Yellow	37.99
400883	12" Step 3	Green	37.99
400884	13" Step 1	White	39.99
400885	13" Step 2	Yellow	39.99
400886	13" Step 3	Green	39.99
400890	17" Step 1	White	65.99
400899	17" Step 2	Yellow	65.99
400892	17" Step 3	Green	65.99
400893	20" Step 1	White	75.99
400894	20" Step 2	Yellow	75.99
400895	20" Step 3	Green	75.99

Tool Type	Backing	Type of Cutting Action	Typical Use	Typical Equipment	Size	Grit
Surface Pro Gold VTX Restore Hybrid Dots	Rubber	Very Aggressive	Faster cutting of concrete on initial steps	Propane burnisher, auto scrubber, heavy floor buffer, planetary grinder	7" through 21"	30, 50, 100, 200
Surface Pro Gold VTX Restore Dots	Rubber	Light Honing and All Polishing	Light honing and all polishing of concrete, terrazzo and natural stone	Propane burnisher, auto scrubber, standard floor buffer, planetary grinder	7" through 21"	400, 800, 1800, 3000
Surface Pro Gold VTX Terrazzo Monroe Polish Pads	Natural Hog Hair	Light Honing and All Polishing	Light honing and all polishing of concrete, terrazzo and natural stone. Provides highest gloss of any of the Vortex tools	Propane burnisher, auto scrubber, standard floor buffer, planetary grinder	7" through 20"	400, 800, 1800, 3000, 8500
Surface Pro Gold VTX DIP Polishing Pads HD	Nylon Floor Pad	All Polishing	Burnish concrete to a high gloss, burnish stain guard products. Not recommended for natural stone and terrazzo.	Propane, battery or electric high speed burnisher, planetary grinder	7" through 27"	400, 800, 1500, 3000, Black Buff
Surface Pro Gold VTX Maintenance Pad	Nylon Floor Pad	All Polishing Plus Routine and Periodic Cleaning	Maintain polish of concrete. Final step for polishing terrazzo and marble. Can be used for periodic cleaning with auto scrubber.	All floor care equipment and planetary equipment	7" through 27"	step 1 800, step 2 1500, step 3 3000
Surface Pro Select Maintenance Pad	Nylon Floor Pad	All Polishing Plus Routine and Periodic Cleaning	Maintain polish of concrete. Final step for polishing terrazzo and marble. Can be used for periodic cleaning with auto scrubber.	All floor care equipment and planetary equipment	12", 16", 17", 20" and 27"	400, 800, 1500, 3000

Floor Sanding Screens

- Silicon carbide sanding screens
- 25 per Box

Stock No.	Diameter	Grade	Price
920450	17"	60	\$5.79
920452	17"	80	5.79
920454	17"	120	5.79
920460	17"	220	5.79
920465	17"	320	5.79



Spray Back Sandpaper

- Box of 25
- 17" sanding discs

Stock No.	Diameter	Grade	Price/Ea.
950087	17"	60	\$4.25
950088	17"	80	4.25
950090	17"	120	4.25



NEW!

Craftsmans Choice® Jumbo Steel Wool Pads

Craftsman's Choice steel wool's high absorbency translates into minimal clogging. Use on almost any type of floor for fine scratch removal and final polishing. Available in sizes from 16" to 20" and in grades #00 - #2. Sold in cases of 12 pads.

Stock No.	Diameter	Grade	Price
447963	17"	0	\$65.16
447964	17"	1	65.16
447965	17"	2	65.16
447966	19"	0	108.00
447967	19"	1	108.00
447968	19"	2	108.00
447970	20"	00	108.00
447969	20"	0	108.00
447971	20"	1	108.00

Craftsmans Choice® Metrix Steel Wool Pads

Craftsman's Choice pads provide the best results over a wide range of floor types. With excellent life and durable metrix design, this steel wool is sure to get the job done. Use for stripping, cleaning, and polishing. Metrix steel wool pads are available in a large range of sizes from 7" to 24" and in grades from #00 to #3. Sold in cases of 12 pads.



NEW!

Stock No.	Diameter	Grade	Price
447927	7"	00	\$30.00
447926	7"	0	29.00
447928	7"	1	29.00
447929	7"	2	29.00
447933	17"	00	61.55
447932	17"	0	61.55
447935	17"	1	61.55
447937	17"	2	61.55

Stock No.	Diameter	Grade	Price
447948	19"	00	\$76.56
447947	19"	0	74.51
447946	19"	1	69.00
447950	20"	00	80.48
447949	20"	0	80.48
447951	20"	1	80.48

**BUY IN CASES
SAVE 5%!**



Surface Pro® Select Metrix Flat Steel Wool Pads

- Pre-shaped for smooth operation
- Packed 12 per case, individually poly-wrapped
- Other sizes (5", 10", 12", 14", 16", 18" & 22") and grades (000, 00, 3) available for special order
- 7" stitched flat for higher speed balance

Stock No.	Size	Grade	Price/Case	Price/Ea.
115065	7"	0	\$30.55	\$2.68
115066	7"	1	30.55	2.68
115067	7"	2	30.55	2.68
115078	17"	0	68.29	5.99
115079	17"	1	68.29	5.99

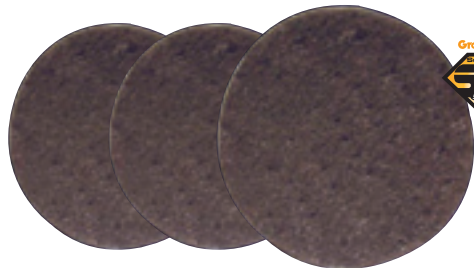

**BUY IN CASES
SAVE 5%!**

Surface Pro® Select Jumbo Steel Wool Pads

- Highest quality available
- Pre-shaped for smooth operation
- Packed 12 per case
- Individually poly-wrapped
- Other sizes (5", 10", 12", 15", 16" 14", 18" & 22") and grades (000, 00, 3) available for special order

Stock No.	Size	Grade	Price/Case	Price/Ea.
115054	17"	0	68.29	\$5.99
115055	17"	1	68.29	5.99
115056	17"	2	80.37	7.05
115057	19"	0	72.73	6.38
115058	19"	1	72.73	6.38
115059	19"	2	72.73	6.38
115061	20"	0	100.43	8.81
115062	20"	1	100.43	8.81
115063	20"	2	85.39	7.49



Surface Pro® 5 Lb. Steel Wool Roll

- Highest quality available
- Convenient roll format
- Packaged 12 rolls per case

Stock No.	Size	Grade	Price/Ea.
340151	13"	0	\$20.67
340152	13"	1	20.67
340153	13"	2	20.67

Makita® VC4710 XTRACT 12 Gallon HEPA Wet/Dry Vacuum



A powerful 12 AMP motor generates 135 CFM of suction power and 92" of water lift to take on the most challenging applications.

Motor chamber is constructed of quality sound-absorbing materials resulting in a quiet operating sound level of 59 dB(A). Automatic Filter Cleaning System with blow-back feature is timed at set intervals to maintain filter performance for longer filter life.

- 126 CFM
- 35 lbs.
- 120V / 11.5 AMP
- Holds up to 40 lbs. of dust & debris

Stock No.	Description	Price
471000	HEPA 12 Gal. Vacuum.....	\$663.95

Dustless Technologies® 16 Gallon HEPA Wet/Dry Vacuum

Dustless Technologies' 16 Gallon HEPA Wet/Dry Vacuum enables you to switch from dry to wet operation without danger of getting the valuable HEPA filter wet. A protective baffle/wall inside the canister protects the HEPA filter from water. Comes with 2 extension wands, 1 HEPA filter and cover, 2 Wunderbag micro pre-filter, 1 service tool and 1 floor tool.

- 126 CFM
- 35 lbs.
- 120V / 11.5 AMP
- Holds up to 40 lbs. of dust & debris

Stock No.	Description	Price
160600	HEPA 16 Gal. Vacuum w/12ft. Hose.....	\$608.99
133010	Wet/Dry HEPA Filter, Cover.....	24.10
132010	Wet/Dry HEPA Filter.....	167.95

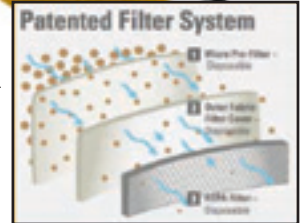
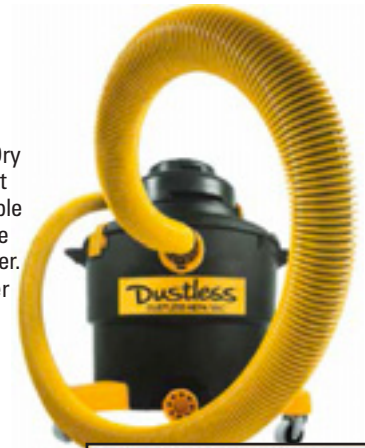

Dustless Technologies® Wet/Dry Vacuum

- Switch from dry to wet vacuuming without changing filters
- Excellent for drywall, concrete, stone & fiberglass
- Filters are washable (can be put in clothes washing machine)
- CFM 126.39
- Patented double filter system.
- Will never blow dust, not even on startup
- Disposable WunderBag micro pre-filter keeps inner and outer filters clean
- Includes: 2 extension wands, 1 inner and outer filter, 2 Wunderbag micro pre-filter, 1 service tool, 1 floor tool

Stock No.	Description	Price
114300	D1603 Dustless Vacuum.....	\$398.95

Accessories

Stock No.	Description	Price
114902	Replacement Filters, Prim. + Sec. (2/Set).....	\$48.83
114903	Micro Pre Filter (2/Set).....	25.73



Dustless Technologies®

**Tear Resistant
Retains Strength
When Wet**



Metabo® ASR35 HEPA Wet/Dry Vacuum

The METABO ASR35 ACP Vacuum meets or exceeds all regulatory standards concerning HEPA vacuums and provides the highest level of job-site dust containment. The ASR35 ACP is made in Germany. Use for extraction from the power tool in continuous mode, both on construction sites and in the workshop, this compact vacuum cleaner is great for removal of liquids and dry solids. Utilizes AutoCleanPlus to save costs and time thanks to automatic MPulse filter cleaning allowing for continuous use. If the vacuum senses a pressure difference from one side of the filters to the other, the filters are vibrated immediately, clearing the filters without interrupting suction.

- Especially suited for extracting concrete and rock dust
- Suction power control for adapted suction performance
- Power socket- vacuum starts automatically when a tool plugged into the tool outlet is turned on
- Twin polyester filter cassettes with large filter area for constantly high suction capacity

Stock No.	Description	Price	Stock No.	Description	Price
569374	Metabo ASR35 ACP Vacuum.....	\$699.99	631934	Polyester Filter Set, 2.....	\$196.60
630343	9 Gal. Pre-Filter Bags, 5-PK.....	38.20	630326	HEPA Filter Set, 2.....	281.51
630325	Pre-Collection Bags, 5-PK.....	68.77			
631935	Paper Filter Collection Bags, 5-PK.....	46.40			





DustBuddie™

Dust Containment Shroud with brush skirt for use on hand grinders.

- Fits most 4" - 5" hand grinders
- Removable front edge of shroud for grinding close to wall or edge

Stock No.	Description	Price
114922	5" dia. x 18" x 1.5" Hose	\$83.95
114923	7" dia. x 18" x 1.5" Hose	88.15

PEARL



Pearl® Dust Cover for 4 1/2-5" Grinders

For effective dust control when grinding concrete, masonry or mortar.

- Fits 4 1/2" - 5" grinders including Milwaukee, Dewalt, Metabo, Makita, and Bosch
- Includes: Clamp, Cup nut assembly

Stock No.	Price
677350.....	\$72.95

PEARL



Pearl® Hinged Dust Cover

Hinged front for grinding against walls & edges. Effective dust control when grinding concrete, masonry, mortar.

- Fits 7" and 9" grinders including Milwaukee, Dewalt, Metabo, Makita, and Bosch
- Includes: Clamp, 5 Shroud spacers

Stock No.	Price
677351.....	\$87.50

CutBuddie™

Dust Containment Shroud for hand grinders.

- Fits most 4" and 5" grinders
- Fast, easy installation using bracket band & clamp combination
- Clear polycarbonate for durability & visibility
- Captures up to 99% of airborne dust

Stock No.	Description	Price
114949	5" Cutbuddie w/18" Hose.....	\$104.95
001750	7" Cutbuddie w/18" Hose.....	115.95



Ermator® 7" Deluxe Dust Shroud

Dust Shroud attachment collar with multiple rings to allow the dust shroud to be attached to most common hand grinders.

- Swivel for attachment of 1.5" and 2" hoses
- Flexible rubber flange for working contours
- Flip up wall hinge can be folded up and clear of walls while working corners
- Vent hole to adjust suction

Stock No.	Price
869839.....	\$192.78

Gelmaxx Eco-Quick Gel

GelMaxx Eco-Quick Ge solidifier absorbs slurry solids into a safe material that can be disposed of immediately. Meets the EPA Method 9095B Paint Filter Test and EPA regulations for proper disposal methods. 20 grams per gallon of treated material creates a gel-like substance within minutes that is safe to dispose of in a standard waste container. Can reduce the liability and cost for slurry water disposal.



Stock No.	Desc.	Price
113466	35 lb. Bucket.....	\$180.00
113467	50 lb. Box.....	250.00

Cimex Planetary Head Floor Machines

CIMEX

- Three head planetary machines for concrete, stone and terrazzo floor restoration, lippage removal, grinds freshly poured terrazzo, coatings removal, surface preparation
- Additional 35 lbs. weights available, all machines equipped with vacuum port
- Set of three Velcro™ heads
- For wet or dry use
- High productivity

Stock No.	Description	Price
700119	Cimex 19"	\$4,695.00



Surface Pro® Plus 3" Dry Polishing Pads

- Professional quality diamond polishing discs for concrete
- 12mm thick, 3" (76.2mm) diameter
- 400 and 800 grit deliver a great shine under any machine



Stock No.	Grit/Color	Price
400800	30, Lime Green.....	\$18.25
400802	50, Green.....	18.25
400804	100, Black.....	18.25
400806	200, Red.....	18.25
400808	400, Yellow.....	18.25
400810	800, White.....	18.25
400812	1500, Blue.....	18.25
400814	3000, Gray.....	18.25

Surface Pro® Gold Phenolic Dry Polishing Pads

- Produces the deepest color & highest gloss, DRY USE only
- 6mm Thick, 3" (76.2mm) diameter
- Phenolic bond for aggressive grinding and long life



Stock No.	Grit/Color	Price
400743	50, Green.....	\$21.95
400744	120, Black.....	21.95
400745	220, Red.....	21.95
400746	400, Yellow.....	21.95
400747	800, White.....	21.95
400748	1800, Blue.....	21.95
400749	3500, Gray.....	21.95

Surface Pro® Gold Wet/Dry Metal Pads

- Long life- up to 20,000 square ft.
- 8mm Thick, 3" (76.2mm) Diameter
- Wet or dry use
- Can be used with floor buffers or planetary machines
- Can be used for initial grind and as a transition disc



Stock No.	Description	Price
400101	Metal, 6 Grit.....	\$110.25
400090	Metal, 24 Grit.....	82.95
400100	Metal, 46 Grit.....	82.95
400102	Metal, 70 Grit.....	72.95
400105	Metal, 120 Grit.....	72.95
400107	Metal, 220 Grit.....	72.95
400104	Copper, 120 Grit.....	57.95
400106	Copper, 220 Grit.....	57.95



Surface Pro® Plus Wet Polishing Pads

- Professional quality diamond discs for concrete
- 12mm Thick, 3" (76.2mm) Diameter
- Unique labyrinth design with large water channels
- Beveled edges for smooth cutting

Stock No.	Grit/Color	Price	Stock No.	Grit/Color	Price
400200	50, Green	\$21.95	400208	800, White	\$21.95
400202	120, Black	21.95	400210	1800, Blue	21.95
400204	220, Red	21.95	400212	3500, Gray	21.95
400206	400, Yellow	21.95	400214	8500, Purple	21.95



Surface Pro® Plus Triple Thick Resin Bond Wet Pads

- Professional quality diamond polishing discs for WET USE on concrete, marble, granite & terrazzo
- 7mm Thick, 3" (76.2 mm) Diameter
- Beveled edges for smooth cutting

Stock No.	Grit	Price	Stock No.	Grit	Price
400937	50	\$16.25	400942	800	\$16.25
400938	120	16.25	400943	1800	16.25
400939	220	16.25	400944	3500	16.25
400940	400	16.25	400945	8500	16.25
400941	600	16.25			



Surface Pro® Select 3" Wet Polishing Pads

- Professional quality diamond polishing discs for concrete, marble, granite & terrazzo
- 6mm Thick, 3" (76.2mm) Diameter
- Unique labyrinth design with large water channels
- Beveled edges for smooth cutting

Stock No.	Grit	Price	Stock No.	Grit	Price
400500	50	\$17.95	400508	800	\$17.95
400502	120	17.95	400510	1800	17.95
400504	220	17.95	400512	3500	17.95
400506	400	17.95	400514	8500	17.95



Surface Pro® Plus Phenolic Hybrid Polishing Wet/Dry Pads

- Provides a high quality shine at an economical price.
- Dry or Wet Use
- 9mm Thick, 3" (76.2mm) Diameter
- Excellent reflectivity and clarity
- Reusable storage container



Stock No.	Grit/Color	Price	Stock No.	Grit/Color	Price
401800	30, Blue	\$17.25	401804	400, Light Blue	\$17.25
401801	50, Light Green	17.25	401805	800, Green	17.25
401802	100, Red	17.25	401806	1500, Orange	17.25
401803	200, Yellow	17.25	401807	3000, Pink	17.25



DETAILING TOOLING & SUPPLIES

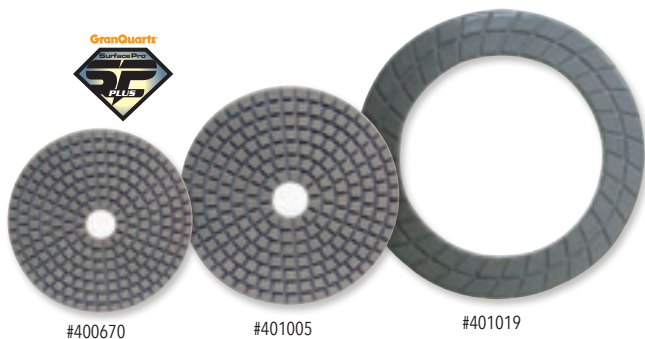

#400670

#401005

#401019

Surface Pro® Plus Flexible Dry Polishing Pads for Concrete

- Color coded Velcro® backing for ease of use
- High quality finish with no residue
- For concrete, marble, granite & terrazzo
- Beveled edges for smooth cutting
- For use on hand polishers

Stock No.	Description	Price	Stock No.	Description	Price
401005	... 30 Grit, Green, 5"	\$22.75	401020	... 50 Grit, Dk. Green, 7"	\$31.99
401006	... 50 Grit, Dk. Green, 5"	22.75	401021	... 120 Grit, Black, 7"	31.99
401007	... 120 Grit, Black, 5"	22.75	401022	... 220 Grit, Red, 7"	31.99
401008	... 220 Grit, Red, 5"	22.75	401023	... 400 Grit, Yellow, 7"	31.99
401009	... 400 Grit, Yellow, 5"	22.75	401024	... 800 Grit, White, 7"	31.99
401011	... 800 Grit, White, 5"	22.75	401025	... 1800 Grit, Blue, 7"	31.99
401012	... 1800 Grit, Blue, 5"	22.75			
401013	... 3500 Grit, Gray, 5"	22.75			

Flex Edge



Diskit® Threaded Foam Rubber Back-Up Heads

- Q.R.S.-backed, tough and flexible polyester urethane foam body
- Maximum 10,000 RPM
- Flexible edge allows pad to conform to surface contours
- M8 x 1-1/4" for Makita GV5000

Stock No.	Thread	Description	Price
912118	5/8"-11F	4" QRS	\$18.79
116806	5/8"-11F	5" PSA	15.59
116798	5/8"-11F	5" PSA/flx edg	15.59
116809	5/8"-11F	5" QRS	21.99
116802	M8-1/4"-M	5" PSA	15.59
116814	5/8"-11F	7" QRS	27.15
696104	5/8"-11F	7" canvas/flx	23.95
696105	5/8"-11F	7" PSA/flx	28.15

Pro Series® Diamond Abrasive Hand Pads

- Wet or dry use
- Excellent on Marble and a variety of other materials
- Available in 2 3/8" x 4"

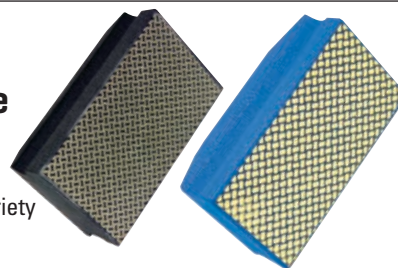

Stock No.	Grit	Price	Stock No.	Grit	Price
108584	50	\$20.95	108588	800	\$11.95
108585	100	18.95	108589	1500	9.95
108586	200	13.95	108590	3000	9.95
108587	400	13.95			

Our TOP of The Line POLYESTER Adhesive!



Legend Premium®

Clear and smooth Legend Premium Polyester Adhesive easily fills, bonds and laminates all types of stone. Formulated for outstanding performance, Legend Premium is silky smooth and can be tinted to match any natural or engineered stone.

Stock No.	Description	Price
112950	Transparent Flowing 1 Quart.....	\$14.95
112951	Transparent Flowing 1 Gallon.....	51.95
112952	Transparent Flowing 5 Gallon Drum.....	184.95
699128	Transparent Flowing BIG BOX (4 x 1.25 Gallon Cans)	194.95
112953	Transparent Knife Grade 1 Quart.....	14.95
112954	Transparent Knife Grade 1 Gallon.....	51.95
112955	Transparent Knife Grade 5 Gallon Drum.....	184.95
699129	Transparent Knife Grade BIG BOX (4 x 1.25 Gallon Cans)	194.95

***BIG BOX** contains (4) 1 1/4 gallons (5 gallons total) but eliminates costly hazardous shipping fees.
Big Box = One 5 gallon bucket, hardener is included.

Pro Series® Polyester Adhesives

Pro Series Polyester is our house line of **affordably priced, top-quality adhesives** for natural stone. **Pro Series** is proven in extensive testing to produce the most brilliant shine, used alone or with added color. High grade fillers ensure a smooth consistency with **supreme bonding strength** and **very fast drying time**.

Stock No.	Description	Price
117312	Transparent Flowing 1 Quart.....	12.95
117313	Transparent Flowing 1 Gallon.....	44.95
117314	Transparent Flowing 5 Gallon Drum.....	169.95
699131	Transparent Flowing BIG BOX (4 x 1.25 Gallon Cans)	179.95
117315	Transparent Knife Grade 1 Quart.....	12.95
117316	Transparent Knife Grade 1 Gallon.....	44.95
117317	Transparent Knife Grade 5 Gallon Drum.....	169.95
699132	Transparent Knife Grade BIG BOX (4 x 1.25 Gallon Cans)	179.95
117300	Buff Flowing 1 Quart.....	18.95
117303	Buff Knife Grade 1 Quart.....	18.95
117304	Buff Knife Grade 1 Gallon.....	66.95
117306	White Flowing 1 Quart.....	18.95
117309	White Knife Grade 1 Quart.....	18.95
117310	White Knife Grade 1 Gallon.....	66.95



***BIG BOX** contains (4) 1 1/4 gallons (5 gallons total) but eliminates costly hazardous shipping fees.
Big Box = One 5 gallon bucket, hardener is included.

High Quality Polyester at VALUE Pricing!

GranQuartz Recon™

Recon™ polyester from GranQuartz is an economical polyester adhesive for the fabricator/installer focused on his bottom line. Available in a cost effective 5 gallon drum, Recon is formulated with quality fillers for smooth, fast setting and consistent results. Choose flowing or knife grade.



Stock No.	Description	Price
112956	Transparent Flowing 5 Gallon Drum.....	\$142.95
696337	Transparent Knife Grade 5 Gallon Drum.....	142.95

Cream Hardener

Hardening paste for adhesives.

Stock No.	Units	Price
1171751oz. Tube.....	\$3.95
1172194oz. Tube.....	6.95



GranQuartz Legend® Hybrid Adhesive

A high quality adhesive blend that gives the strength of an epoxy with the speed and ease of a polyester adhesive. GranQuartz Legend® HYBRID Polyester/Epoxy adhesive has a unique viscosity that is thicker than flowing but thinner than knife grade and can be used on any vertical application, seams or lamination.



Stock No.	Description	Price
112957	HYBRID 1 Quart.....	\$20.95
112958	HYBRID 1 Gallon.....	66.95
112959	HYBRID 5 Gallon Drum.....	288.95
699130	HYBRID BIG BOX (4 x 1.25 Gallon Cans)	296.95



Superior

Superior Gold

Strong enough to withstand the pressure of CNC or automatic edge machines, Superior's resin technology outperforms epoxy systems for Indoor and outdoor applications with excellent UV stability.

Stock No.	Description	Price
698940	Knife Grade, Quart	\$19.95
698941	Knife Grade, Gallon.....	66.95
698942	Knife Grade, 5 Gallon Drum	298.95
699133	Knife Grade BIG BOX (4 x 1.25 Gallon Cans)	306.95
698944	Flowing, Quart	19.95
698945	Flowing, Gallon.....	66.95
698946	Flowing, 5 Gallon Drum	298.95
699134	Flowing, BIG BOX (4 x 1.25 Gallon Cans).....	306.95

***BIG BOX** contains (4) 1 ¼ gallons (5 gallons total) but eliminates costly hazardous shipping fees.
Big Box = One 5 gallon bucket, hardener is included.

NEW!



Superior

Superior Fusion FV-5

Superior FUSION is a blend of Vinyl Ester and Modified Acrylic adhesive technology. Perfect for seaming, mitring, laminating and chip repair applications on natural stone, engineered stone, sintered, ultra-compact and other dense material. Fusion FV-5 has a smooth paste consistency with enhanced color & clarity, excellent for color matching.

- Smooth paste consistency similar to Superior Poly-Epoxy

Stock No.	Description	Price
699250	Fusion FV-5 Knife Grade Quart	\$20.95
699251	Fusion FV-5 Knife Grade Gallon.....	67.95
698952	Fusion FV-5 Knife Grade 2-Pack (2½ Gallons).....	145.95
698953	Fusion FV-5 Knife Grade 5 Gallon Drum	276.95
698954	Fusion FV-5 Knife Grade BIG BOX (4 x 1.25 Gallon Cans).....	284.95

NEW!



Superior

Superior Fusion FV-9

Superior FUSION is a blend of Vinyl Ester and Modified Acrylic adhesive technology. Perfect for seaming, mitring, laminating and chip repair applications on natural stone, engineered stone, sintered, ultra-compact and other dense material. Fusion FV-9 has a thicker knife grade consistency similar to Superior V-MAX SV-9. Fusion FV-9 also has enhanced color & clarity, excellent for color matching.

- Thicker, knife grade consistency similar to Superior V-MAX SV-9

Stock No.	Description	Price
699255	Fusion FV-9 Full Knife Grade Quart	\$20.95
699256	Fusion FV-9 Full Knife Grade Gallon.....	67.95
699257	Fusion FV-9 Full Knife Grade 2-Pack (2½ Gallons).....	145.95
699258	Fusion FV-9 Full Knife Grade 5 Gallon Drum	276.95
699259	Fusion FV-9 Full Knife Grade BIG BOX (4 x 1.25 Gallon Cans).....	284.95

Superior Fusion Vinyl Ester/Modified Acrylic Adhesives

Superior Fusion is perfect for seaming, mitring, laminating and rodding. Use with natural stone, engineered stone, sintered, ultra-compact and other dense material. Fusion's colors are the perfect balance of translucent and opaque coloring for perfect color matching. Smooth, no-drip consistency makes Great for vertical and horizontal applications, has fast gel / fast cure, polishes easily and has a 1-year shelf life in a controlled climate.

- Fast gel, fast curing, easy to polish
- Superior bonding strength
- Excellent shelf stability of 1 year
- Packaged in cases of six (6) 250ML cartridges
- Each cartridge includes two (2) tips

Stock No.	Unit	Color	Price
699262	250ML	Glacier.....	\$28.95
699263	250ML	Pure White	28.95
699267	250ML	Galaxy Black	28.95
699272	250ML	Beach	28.95
699260	250ML	Chameleon.....	28.95
699261	250ML	Transparent White....	28.95
699265	250ML	Translucent	28.95
699270	250ML	Oyster.....	28.95
699264	250ML	Perfect White.....	28.95
699271	250ML	Newport Grey.....	28.95
699268	250ML	Dusk.....	28.95
699269	250ML	Graphite.....	28.95
699273	250ML	Beige Olimpo.....	28.95
699274	250ML	Transparent Black.....	28.95
699266		Static Mixing Tip, ONE.....	\$2.40

NEW!



Superior



Superior

Superior® V-Max Adhesives

V-MAX is a 100% vinyl-ester stone adhesive made from specially formulated high quality resins. V-Max is available in 3 different viscosities: V-Max SV-1 is the consistency of syrup and is pourable, and V-Max SV-9 is a thick paste.

All V-Max adhesives are formulated for natural and engineered stone surfaces.

- V-Max SV-1: Laminating, rodding, crack repair
- V-Max SV-9: Seaming, laminating, miter joints, crack repair, chip repair

All adhesives require proper storage for maximum shelf life and best performance. **V-Max vinyl-ester** adhesives are more sensitive to high temperatures than traditional polyesters. Manufacturer's recommended storage temp: **NO HIGHER THAN 75° F.**

Stock No.	Description	Price
699140	V-Max SV-1, Quart	\$19.95
699141	V-Max SV-1, Gallon	63.95
699143	V-Max SV-1, 5 Gallon Pail.....	260.95
699144	V-Max SV-1, BIG BOX (4 x 1.25 Gallon Cans)	268.95
699150	V-Max SV-9, Quart	\$19.95
699151	V-Max SV-9, Gallon	63.95
699153	V-Max SV-9, 5 Gallon Pail.....	260.95
699154	V-Max SV-9, BIG BOX (4 x 1.25 Gallon Cans)	268.95

Superior Pearl

A very light/white pearlescent color knife grade for seaming with "invisible" joints on lighter colored stones including white marble. Perfect for indoor applications, Pearl has a 3-5 minute working time with full cure in less than 20 minutes. Available in 3 knife grade consistencies:

- **FULL Knife Grade** is a more "typical" knife grade consistency
- **EHC** is thicker with less shear "paste" for high quality mitered edges.
- **Preferred** has a consistency similar to Superior Poly-Epoxy



Superior

***BIG BOX** contains (4) 1 1/4 gallons (5 gallons total) but eliminates costly hazardous shipping fees. Big Box = One 5 gallon bucket, hardener is included.

Stock No.	Description	Price
698953	Full Knife Grade, Quart.....	\$18.95
698954	Full Knife Grade, Gallon	59.95
698956	Full Knife Grade, 5 Gallon Drum.....	245.95
699138	Full Knifegrade, BIG BOX (4 x 1.25 Gallon Cans)	255.95
698963	EHC Knife Grade, Quart.....	\$18.95
698964	EHC Knife Grade, Gallon	59.95
698965	EHC Knife Grade, 2-Pack (2 1/2 Gallons).....	142.95
698966	EHC Knife Grade, 5 Gallon Drum	245.95
699139	EHC Knifegrade BIG BOX (4 x 1.25 Gallon Cans)	253.95
698980	Preferred Knife Grade, Quart	\$18.95
698981	Preferred Knife Grade, Gallon	59.95
698982	Preferred Knife Grade, 2-Pack (2 1/2 Gallons).....	142.95
698983	Preferred Knife Grade, 5 Gallon Drum	245.95
698984	Preferred Knife Grade, BIG BOX (4 x 1.25 Gallon Cans).....	253.95



Superior

Poly-Epoxy Knife Grade

A combination of polyester and epoxy resin technology providing the strongest possible bond available in a polyester.

***BIG BOX** contains (4) 1 1/4 gallons (5 gallons total) but eliminates costly hazardous shipping fees. Big Box = One 5 gallon bucket, hardener is included.

Stock No.	Description	Price
696392	Poly-Epoxy Quart	\$20.95
696394	Poly-Epoxy Gallon	67.95
696396	Poly-Epoxy 5 Gallon Drum.....	290.95
699137	Poly-Epoxy Big Box (4 x 1.25 Gallon Cans).....	298.95



Superior

Superior® Polyesters

Superior Polyesters offer the strongest, fastest setting polyester adhesive for stone applications. Innovative advances in promotion and inhibition technology provide these polyester products with the best combination of fast tack free curing and outstanding shelf life. These advances also give Superior polyesters the lightest cured color for easy color matching.

***BIG BOX** contains (4) 1 1/4 gallons (5 gallons total) but eliminates costly hazardous shipping fees. Big Box = One 5 gallon bucket, hardener is included.

Stock No.	Description	Price
690213	Transp. Flowing, Quart	\$17.95
690214	Transp. Flowing, Gallon	56.95
690215	Transp. Flowing, 5 Gallon Drum.....	207.95
699135	Transp. Flowing, BIG BOX (4 x 1.25 Gallon Cans)	209.95
690210	Knife Grade, Quart	17.95
690211	Knife Grade, Gallon.....	56.95
690212	Knife Grade, 5 Gallon.....	207.95
699136	Knife Grade, BIG BOX (4 x 1.25 Gallon Cans)	209.95
696443	Travertine Filler, Quart.....	17.95

Superior



Superior Acrylic Adhesives

- Fast curing with no tack even in colder temperatures
- Virtually water clear for easy color matching
- Strong bonds to porous and dense stones
- Excellent UV stability for outdoor applications

Stock No.	Description	Price
696391	Penetrating Quart	\$20.95
690233	Quick Set Flowing Quart	24.95
690234	Quick Set Flowing Gallon	96.95
696340	Quick Set Knifegrade Quart	24.95
696341	Quick Set Knifegrade Gallon	96.95



Superior



A&B MIX 1:1 Epoxy Adhesives

These products bond strongly to dense stones and are excellent for outdoor applications. Superior's 1:1 Flowing or Knife-Grade Epoxy formulations give you the latest in high-quality epoxies.

Opaque

Flowing Grade E-1000

695318	2-qt. (1A,1B).....	\$45.95
695319	2-gal. (1A,1B).....	146.95

Knife Grade E-1010

695320	2-qt. (1A,1B).....	\$45.95
695321	2-gal. (1A,1B).....	146.95



Superior

Superior E-5000 Translucent Epoxy

Provides an incredibly strong bond, yet the cured adhesive has flex and toughness. Ideal for freeze/ thaw conditions, cured adhesive can withstand vibrations and shock load during transportation. *E-5010 Knife Grade* epoxy has a silky smooth consistency. Superior Epoxies are sold as "units" E-5000/E-5010 = (2) Part A & (1) Part B Unit. Can be used for indoor and outdoor applications.

- Interior or exterior use
- Strong, flexible cured bond

Stock No.	Unit Amount	Type	Price/Ea.
699183	2 qt.A, 1qt. B.....	Flowing Epoxy	\$68.95
699184	2 gal.A, 1gal. B.....	Flowing Epoxy	220.95
699185	2 qt.A, 1qt. B.....	Knife Grade Epoxy.....	68.95

Superior



Superior® Coloring Pastes

Stock No.	Unit	Color	Price	Stock No.	Unit	Color	Price
696475	1 oz. Tube	White	\$4.95	696474	8 oz. Bottle	White	\$20.95
696161	1 oz. Tube	Black	4.95	696145	8 oz. Bottle	Black	20.95
696420	1 oz. Tube	Red	4.95	696419	8 oz. Bottle	Red	20.95
696417	1 oz. Tube	Red-Brown.....	4.95	696416	8 oz. Bottle	Red-Brown.....	20.95
696382	1 oz. Tube	Ochre	4.95	696380	8 oz. Bottle	Ochre	20.95
696275	1 oz. Tube	Green	4.95	696273	8 oz. Bottle	Green	20.95
696166	1 oz. Tube	Blue	4.95	696163	8 oz. Bottle	Blue	20.95
696170	1 oz. Tube	Brown	4.95	696169	8 oz. Bottle	Brown	20.95
696151	1 oz. Tube	Buff	4.95	696148	8 oz. Bottle	Buff	20.95
696326	1 oz. Tube	Gray.....	4.95	696325	8 oz. Bottle	Gray.....	20.95

Stock No.	Unit	Color	Price
696473	2 oz. Tube	White	\$5.95
696155	2 oz. Tube	Black	5.95
696418	2 oz. Tube	Red	5.95
696414	2 oz. Tube	Red-Brown.....	5.95
696379	2 oz. Tube	Ochre	5.95
696272	2 oz. Tube	Green	5.95
696162	2 oz. Tube	Blue.....	5.95
696168	2 oz. Tube	Brown	5.95
696147	2 oz. Tube	Buff	5.95
696324	2 oz. Tube	Gray.....	5.95

Assortment Kits

Assorted Kit (Box of 8/1 oz. Tubes)
#696137..... **\$32.95 Ea.**

Assorted Kit (Box of 10/2 oz. Tubes)
#696136..... **\$60.95 Ea.**

Akemi® Akepox

Epoxy two-component adhesives are recommended for exterior applications and especially for granite, or when high bonded strength is desired. Akepox products have very low shrinkage during processing and can be tinted for color matching and polished to match the finish of the stone. Exact amount of hardener to mastic must be measured by weight. Thorough mixing of hardener is critical. Available in both Flowing and Knife Grade.

- Interior or exterior use
- Strong, flexible cured bond

Stock #	Description	Price
358552	Akepox 1005, 1.25 Kg.....	\$77.95
358538	Akepox 2000 Flowing, 1.5 Kg.....	77.95
358539	Akepox 2010 Transp. Knife Grade, 2.5 Kg.....	109.95
358544	Akepox 5000 Flowing, 1.5 Kg.....	129.95
358560	Akepox 5010, 2.25 Kg.....	140.95
446922	Akepox 4050 Anthracite, 400 ml. Cart.....	74.80
446932	Akepox 5010 Gel Mix, 50 ml. Cart.....	20.49
446936	Akepox 2010 Trans. Knife Grade, 50 ml. Cart.....	16.09
446938	Akepox 2030 Light Ivory, 400 ml. Cart.....	53.69



Akemi® Platinum Polyester Adhesives

These two-component adhesives with a polyester base are easy to apply, attain a rapid setting, provide a strong bond and are extremely durable. They may be tinted to match the exact color of any stone and they may be polished to a high gloss.

- Interior use
- Strong, rigid cured bond
- Fast curing time
- Gel-like consistency

Stock #	Description	Price
358816	Poly Platinum Knifegrade Blue, 900 ml.....	\$36.95
358828	Poly Platinum Flowing, 900 ml.....	36.50
446876	Platinum EpoxyAcrylate Knife Grade, 4500ml.....	166.10



Akemi® Polyester Adhesives

Akemi Transparent Polyesters are gel-like, knife-grade fillers that will not change consistency by stirring and maintain stability even in higher temperatures. For bonding and filling of natural stone in a vertical position and for modelling corners and edges.

- Interior use
- Excellent polishing ability
- Strong, rigid cured bond
- Easily colored to match any surface
- Gel-like consistency

Stock #	Description	Price
358815	Poly 1000 Trans-L Knife Grade Orange, 900 ml.....	\$27.95
358821	Poly 1000 Trans-L Knife Grade Orange, Gallon.....	116.95
358813	Poly 1000 Trans. Flowing Orange, 900 ml.....	26.95
358892	White Thixo Knife Grade, Quart.....	28.95
358802	Akemi Poly Hardener Paste, 30 g Tube.....	4.95
358812	Akemi Poly Hardener Paste, 150 g Tube.....	17.95
358819	Akemi Acrylic Super Penetrant, 900 ml.....	51.95



Akemi® Hyperclear Adhesives

Gel-like 2-component PUR-adhesive, no bleeding of treated stones, very good yellowing stability, free of solvents, grindable and polishable after approx. 2 h (20°C), can be colored with polyester coloring pastes or concentrates. For high-quality and fast bonding or filling of light-colored, white or transparent crystalline natural and artificial stone and other surfaces.

- Gel-like consistency
- Excellent polishing characteristics
- Use for horizontal or vertical applications

Stock #	Description	Price
664266	Hyperclear 2-Part Adhesive.....	\$123.05



Akemi® Akepox Coloring Pastes

Akemi's Akepox coloring pastes are used to match the color of the filler with that of the specific stone. Akepox coloring pastes are for use with epoxy adhesives. Akepox colorants are available in 1 oz. (30 ml.) tubes, individually or in an assorted set of 8 colors.

COLOR PASTES FOR EPOXY

Stock #	Description	Price
358537	Paste Assortment, 8 x 30ml tubes.....	\$58.95
358526	Brown 30ml Tube Paste.....	7.95
358527	White 30ml Tube Paste.....	7.95
358528	Black 30ml Tube Paste.....	7.95
358529	Ochre/Yellow 30ml Tube Paste.....	7.95
358532	Red/Brown 30ml Tube Paste**.....	7.95



Akemi® ColourBond

Great for fast, simple and reliable production of invisible joints for quartz and natural stone surfaces.

- Interior use
- Excellent polishing ability

Stock #	Description	Price
358595	Mixing Nozzle for 10:1 Cartridge.....	\$1.95
368057	1680 Creme Magic, 250 ml.....	29.95
358612	1640 Cream, 250 ml.....	29.95
358611	1620 Cream, 250 ml.....	29.95
447021	1840 Grey, 250 ml.....	29.95
358613	1650 Cream, 250 ml.....	29.95
368032	1890 Gray Magic, 250 ml.....	29.95
447017	2060 Brown, 250 ml.....	29.95
358609	1140 White, 250 ml.....	29.95
367906	1780 Beige Magic, 250 ml.....	29.95

Stock #	Description	Price
358337	1860 Grey, 250 ml.....	\$29.95
447027	1160 White Magic, 250 ml.....	29.95
358599	1120 White, 250 ml.....	29.95
358608	1130 White, 250 ml.....	29.95
358607	1100 White, 250 ml.....	29.95
368064	1150 White Magic, 250 ml.....	29.95
358634	22000 Transparent, 250 ml.....	29.95
358603	1830 Grey, 250 ml.....	29.95
358623	1805 Grey, 250 ml.....	29.95
358339	1960 Khaki, 250 ml.....	29.95



Akabond Acrylics

Super Penetrating - Low viscosity, perfect for porous stone such as sandstone and limestone. Ideal for laminating granite slabs and filling cracks. 12 - 14 min. cure time

Super Knife Grade - Knife grade acrylic for uses that require a clear bonding similar to light colored stones. Also good for quick production work bonding. 16 - 20 min. cure time

- Quart containers

Stock No.	Description	Price
117193	Super Penetrating	\$26.95



Axson® Acrylic Crack Sealer

- Deep penetrating crack sealer with a water-like consistency.
- Water like viscosity, designed to fill fine cracks and reinforce stone.
- 120 min. cure time

Stock No.	Price
117192	\$25.85



Wood & Stone Polyester Adhesives

Axson Technology Wood and Stone Company Polyester products are ideal for stone installed in a protected environment. Designed especially for stone, polyester adhesives are simple to use, with excellent bonding strength, and cure rapidly at room temperature.

Stock No.	Description	Units/Case	Price/Ea.
117186	Water Clear Flowing, Quart.....	6.....	\$28.95
117188	Water Clear Knife Grade, Quart.....	6.....	29.95
117176	Water Clear Hardener, 1 Oz.....	n/a.....	3.99

Akabond 621KG Resin Epoxy Gel Knifegrade

- Clear epoxy for interior applications
- Excellent bonding to stone



Stock No.	Units/Case	Unit Amount	Color	Price/Ea.
117227	6	1/2 gal. A, 1qt. B.....	Clear.....	\$65.95



Bonstone Ultimate MPH Adhesive

Bonstone Ultimate is a Modified Polyurethane Hybrid (MPH) that is ideal for fabrication shops, onsite installation, restoration and repair and is suitable for structural and cosmetic applications. Ultimate MPH will not fade or degrade in exterior or other demanding conditions. Use for anchoring, bonding mitered corners, stone returns, liner blocks, laminating limestone and more.

- Bonds stone to concrete, metal
- UV color stable
- Fast curing
- Low odor
- Low temperature cure (+40° F)
- Repairs sculptures and monuments

Stock No.	Size	Price
900751	180ml Cartridge.....	\$37.95



Touchstone Edge System (TES)

- Touchstone Edge System has a 2 hour set time at 70° F (applying heat shortens set time)

Stock No.	Contents		Case Size	Price/Case
	Part A	Part B		
900405	2 Gal.....	1 Gal.	Gallons.....	\$322.95
900408	2 Qrt.....	1 Qrt.....	Quarts.....	111.95
900407	2.5 Gal. Pail.....	1.5 Gal. Pail	5 Gallon Pails.....	1,450.95



Touchstone Express II Epoxy

Express II Epoxy is a two-part transparent epoxy available in Flowing or Knife Grade that sets up in 30 to 60 minutes at 75°F, enabling fabricators to work on the edge much faster than with similar epoxies on the market.

- Stone lamination
- Laminating stone to other construction materials (wood, glass, metal)
- Excellent for rodding countertops

Stock No.	Contents		Description	Price/Case
	Part A	Part B		
900621	2 Gals.....	1 Gal.....	Flowing, Gallons.....	\$389.95
900622	2 Qrts.....	1 Qrt.....	Flowing, Quarts.....	130.95
900624	2 Qrts.....	1 Qrt.....	Knife Grade, Quarts	144.95



Touchstone Penetrating Epoxy RS

Touchstone Penetrating Epoxy RS is a water-like epoxy that penetrates deep into stone pores, providing excellent bonding that does not shrink. Great for filling cracks and small fissures in stone. Two hour set time at 70°.

Contents				
Stock No.	Part A	Part B	Case Size	Price/Case
800498	2 Gal.....	1 Gal.....	Gallons.....	\$356.95
800752	2 Qt.....	1 Qt.....	Quarts.....	124.95



Touchstone Penetrating Epoxy

Great for filling cracks and small fissures in stone, this water-like epoxy penetrates deep into stone, provides excellent bond strength and does not shrink. 6-8 hour set time at 70 degrees F.

Contents				
Stock No.	Part A	Part B	Case Size	Price/Case
900434	2 Qt.	1 Qt.....	Quarts- 1/2 Case...	\$136.95



Touchstone T-100 Thickening Powder

Add this lightweight powder to Touchstone Edge System to create a paste or knife-grade epoxy. Ideal for holding steel support rods to the back of stone, anchoring pins or attaching balusters.

Stock No.	Size	Price
900422	Gallon.....	\$17.95



Touchstone Clear Gel Epoxy

This clear super knife-grade epoxy has a smooth, vaseline-like consistency that allows you to squeeze out thin bond lines when clamping. Easily tinted for true colors, Clear Gel Epoxy delivers high bond strength, is polishable and sets up fast. Use the 450ml Ratio-Pac to lay out a bead of fully mixed epoxy; ideal for mounting or repairing countertops, back-beading large or fragile lamination or hard-to-reach areas, or filling hollows behind stone tiles.

- Ratio-Pac includes one mixing nozzle (#900448)
- 2 hour set time at 70 degrees F (applying heat shortens set time)

Contents				
Stock No.	Part A	Part B	Case Size	Price/Case
900412	2 Gal.	1 Gal.....	Gallons.....	\$346.95
900411	2 Qrts.....	1 Qt.....	Quarts	124.95
900440	300ml.....	150ml	Ratio-Pac (450ml).....	44.95
358930.....	Ratio-Pac Nozzle			3.95



BONSTONE Fast Set 39 and Fast Set 41

A two-part, one-to one by volume, epoxy ideal for exterior limestone and granite projects requiring fast setting times.

- Achieves up to 90% full cure within 60 minutes
- Cures at below-freezing temperatures
- Available in Indiana Limestone Buff and Light Gray and Cream
- 20-30 minutes set time at 70° F

Type/Color	Unit Size	Part A	Part B	Stock#	Price/Case
Fast Set 39 Light Gray	Gallons	1 Gal.....	1 Gal.....	900417	\$293.95
	Quarts.....	3 Qts.....	3 Qts.....	900414	288.95
	Hardener	NA	1 5-Gal.Pail.....	900508.....	523.95
Fast Set 41 Buff	Gallons	1 Gal.....	1 Gal.....	900439	293.95
	Quarts.....	3 Qts.....	3 Qts.....	900441	288.95
	Hardener	NA	1 5-Gal.Pail	900476.....	523.95
Fast Set 41 Cream	Gallons	1 Gal.....	1 Gal.....	900477	293.95



Last Patch Gel and Limestone

Specially designed patching compound for limestone and sandstone, camouflages patchwork by absorbing water just like the surrounding porous stone. UV stable, withstands freeze/thaw conditions.

15-25 minutes set time

Last Patch Gel (Transparent)	
Stock No.	Price
900459	\$245.95

- 1 Qt. Part A with thirty-two (32) 1oz. tubes hardener

Last Patch Limestone (Buff)	
Stock No.	Price
900416	\$48.95

- 1 Qt. Part A with four (4) 1oz. tubes hardener

Touchstone Glacier Epoxy

Touchstone Glacier is a fast-curing, non-staining, UV-stable adhesive designed for laminating and fabricating natural stone countertops. Glacier is now available in 5 colors especially for use on light colored miters and seams.

- 8 oz. kits (Part A + Part B)
- Clear is available in 8 oz, 32 oz. or 250ML cartridges
- Non-yellowing, low odor, Zero VOC content
- For Marble, Quartz, Engineered Stone & Granite

Stock No.	Description	Price
310190	Clear (8 oz. +7 Tubes B).....	\$53.95
310191	Clear (250 ml. +1 Tube B).....	14.95
310192	Clear 32 Oz. (Quart +30 Tubes B).....	165.95
310206	Color Kit (8 oz. each,5Colors).....	283.95
310207	Glacier White (8 oz. +7 Tubes B).....	59.95
310208	Bright White (8 oz.+7 Tubes B).....	59.95
310209	Glacier Cream (8 oz. +7 Tubes B).....	59.95
310210	Glacier Gray (8 oz. +7 Tubes B).....	59.95
310193	250ML Cartridge.....	40.95

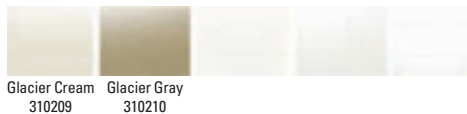

Touchstone T-2000 Epoxy Setting Adhesive

This two component, water cleanable, 100% solid epoxy adhesive compound can be used on most structurally sound, dimensionally stable, dry surfaces for setting marble, ceramic, heavy flooring tile or pavers.

- 2 hour set time at 70 degrees F
- Sold in 1 gallon units
- Exceeds ANSI A.118.3

Stock Number	Price
900415.....	\$69.95

Tenax Multibond Acrylic Adhesive

Multibond is a styrene free acrylic glue for gluing and laminating marble, granite, engineered stone and ceramic surfaces. Multibond is packaged in special cartridges 10:1 bi-axial quantity 250 ml. The glue and the hardener are pre-dosed in the cartridge, once inserted in a proper gun, with special mixer fixed on the top this allows the correct extrusion and mixing of the product which is ready to be used for gluing. The Multibond is characterized to have an excellent adhesion in short time, so you can cut and polish the assembled parts in a short time, 30 min. The hardened product is flat, shining and very polishable.

- Wide range of colors
- Very fast curing time
- Styrene free
- For indoor use

Stock #	Description	Price
446901	Natural Spring, 250 ml.....	\$32.53
446902	Kilimanjaro, 250 ml.....	32.53
446903	Starlight, 250 ml.....	32.53
446904	Clean White, 250 ml.....	32.53
923395	Quartzite, 250 ml.....	32.53
923397	Platinum, 250 ml.....	32.53
923452	Custard, 250 ml.....	32.53
923472	Casper, 250 ml.....	32.53
923461	Parchment, 250 ml.....	32.53
923469	Lace White, 250 ml.....	32.53
923470	White Sail, 250 ml.....	32.53
923471	Picket Fence, 250 ml.....	32.53
923473	Cue Ball, 250 ml.....	32.53
923474	Chalk White, 250 ml.....	32.53
923475	Marble, 250 ml.....	32.53
923403	Midnight, 250 ml.....	32.53
923406	Blackbird, 250 ml.....	32.53
923466	Foggy, 250 ml.....	32.53
923141	Mixing Tip w/Orange Cap.....	1.99





Tenax "H" Knife Grade Polyester

Tenax Knife Grade H is a high viscosity polyester adhesive used vertically or horizontally to repair, rebuild, bond, and fill. Knife grade H cures shiny, is very polishable and colors well to match the stone.

- Cures fast, extremely strong bond
- Recommended for interior use

Stock No.	Unit	Price
923205	1 Liters	\$13.95
923206	4 Liters	48.95
923207	17 KG	165.95



Tenax Knife Grade Tixo Polyester

Tenax Knife Grade Tixo is a high viscosity polyester adhesive used to vertically or horizontally repair, rebuild, bond, and fill. Very smooth in consistency, cures shiny.

- Cures fast, extremely strong bond
- Recommended for interior use

Stock No.	Unit	Price
923200	1 Liter	\$14.95
923201	4 Liters	51.95
923202	17 KG	183.95



Tenax Crystal Transparent Knife Grade

High quality polyester mastic used to vertically or horizontally repair, rebuild, bond, and fill. Crystal is very smooth in consistency, and will cure shiny, is very polishable and colors easily to match granite and other stones. It is perfectly suited for any application where the adhesive or seam/joint must be hidden.

Stock No.	Unit	Price
691155	1 Liter	\$28.95



Tenax Crystal Flowing Water Clear Polyester

Crystal flowing is a high quality polyester mastic used to horizontally repair, rebuild, bond, and fill. Crystal is free flowing and will cure shiny, is very polishable and colors easily to match granite and other stones. Not suitable for temperatures below 32°.

- Cures fast, extremely strong bond
- UV resistant
- Recommended for interior use

Stock No.	Unit	Price
923231	1 Liter	\$28.95



ProSpec B-150 Epoxy Tile/Countertop Adhesive

2-part tile setting epoxy, consisting of a resin and a hardener. One of our superior ceramic tile adhesives or pavers. ProSpec B-150 is a 100% solid, acid and alkali resistant tile setting epoxy.

- Set most types of ceramic tile or stone
- High bond strength
- 100% solid, acid & alkali resistant
- Exceeds ANSI A118.3

Stock Number	Desc.	Price
693577	Gallon.....	\$69.95



Latapoxy 310 Stone Adhesive

LATAPOXY 310 Stone adhesive is a two component building code approved, high strength construction epoxy adhesive for spot bonding large format tile and stone on vertical surfaces, for either interior or exterior applications. Available in a standard 45 minute set version or a rapid 5 minute version.

Stock No.	Description	Price
200460	Cartidge Pack Standard Set 300 x 300ml A&B.....	\$34.61
200462	Cartidge Pack Rapid Set 300 x 300ml A&B.....	44.25
200463	Cordless Mixer	669.96
200464	Mixing Nozzles.....	9.05
200465	10 Liter Pack Standard Set 5 x 5L A&B.....	340.44
200466	10 Liter Pack Rapid Set 5 x 5L A&B.....	454.29
200467	1 Liter Pack Rapid Set 1/2 x 1/2L A&B	57.75
200468	1 Liter Pack Standard Set 1/2 x 1/2L A&B	40.38

Superior E-1500 Epoxy

Two part epoxy system for installing natural and engineered stone, solid surfaces, counter tops, tile, pavers and more. Creates thick bed of epoxy allowing adjustment of material. Can be used over existing tile, plywood or other substrates.

- 1-2 hour set time at 70 degrees F
- Sold in 1 gallon units
- 25-75 Square feet coverage per gallon

Stock No.	Price
698948	\$55.95



Supertor

Superior E-1500-S Epoxy

E-1500-S is a slower setting two part epoxy system for installing natural and engineered stone, solid surfaces, counter tops, tile, pavers and more. Creates thick bed of epoxy allowing adjustment of material. Can be used over existing tile, plywood or other substrates.

- 2-3 hour set time at 70 degrees F
- Sold in 1 gallon units
- 25-75 Square feet coverage per gallon

Stock No.	Price
698949	\$55.95

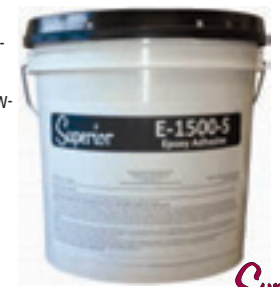

Supertor

Nitro One Shot Adhesives

Superior bond strength and excellent color matching for granite, quartz, porcelain, and solid surfaces.

NEW!

Stock No.	Description	Price
334020	Nitro One Shot, 250ml 199 Clear.....	\$26.99
334021	Nitro One Shot, 250ml 200 Fog	26.99
334036	Nitro One Shot, 250ml 310 Dune.....	26.99
334158	Nitro One Shot, 250ml 822 Bright White.....	26.99
334160	Nitro One Shot, 250ml 824 Butterscotch.....	26.99
334162	Nitro One Shot, 250ml 826 Magic	26.99
334190	Nitro One Shot, 250ml 868 Neutral	26.99
334057	Nitro One Shot, 250ml 518 Pewter	26.99
334064	Nitro One Shot, 250ml 525 Shale	26.99
334065	Nitro One Shot, 250ml 526 Clay	26.99
334067	Nitro One Shot, 250ml 528 Espresso	26.99
334070	Nitro One Shot, 250ml 532 Midnight	26.99
334072	Nitro One Shot, 250ml 534 Pitch	26.99
334091	Nitro One Shot, 250ml 627 Flax.....	26.99
334137	Nitro One Shot, 250ml 788 Champagne.....	26.99
334142	Nitro One Shot, 250ml 797 Nougat.....	26.99
334155	Nitro One Shot, 250ml 819 Russet.....	26.99
334168	Nitro One Shot, 250ml 833 Autumn Light.....	26.99
334180	Nitro One Shot, 250ml 852 Storm Grey.....	26.99
334181	Nitro One Shot, 250ml 853 Thunder Grey.....	26.99
334191	Nitro One Shot, 250ml 869 Newport Grey.....	26.99
334192	Nitro One Shot, 250ml 871 Stellar Grey.....	26.99
334026	Nitro One Shot, 250ml 220 Misty	26.99
334030	Nitro One Shot, 250ml 228 Beige.....	26.99
334060	Nitro One Shot, 250ml 521 Lava	26.99
334069	Nitro One Shot, 250ml 530 Coal.....	26.99
334133	Nitro One Shot, 250ml 784 Medea	26.99
334135	Nitro One Shot, 250ml 786 White Linen.....	26.99
334166	Nitro One Shot, 250ml 831 Aqueous	26.99
334204	Nitro One Shot, 250ml 891 Newgale Grey.....	26.99
334233	Nitro One Shot, 250ml Rodding/Clip Adhesive	26.99
334016	Nitro One Shot, 250ml 116 Newport.....	26.99
334023	Nitro One Shot, 250ml 214 Natural	26.99
334052	Nitro One Shot, 250ml 510 Pearl	26.99
334184	Nitro One Shot, 250ml 856 Ubatuba.....	26.99
334197	Nitro One Shot, 250ml 881 Brazilian Brown	26.99
334066	Nitro One Shot, 250ml 527 New Concrete	26.99

Nitro is shop proven to provide excellent adhesion to stone, quartz, porcelain, marble, polyesters, acrylics and many other hard surfaces. The new improved semi-dripless viscosity makes Nitro the perfect thickness for creating tighter joints with less product waste. Nitro's broad range of colors allows matching most other adhesives on the market easy using fewer cartridges, and comprehensive color charts are available online at granquartz.com for quick reference. All Nitro One Shot adhesives are GreenGuard Certified (qualifies for LEED projects), with increased shelf life and stronger bonding of all stone and quartz surfaces.

Nitro One Shot Adhesive Gun

For use with all 250ML Nitro cartridge adhesives.

Stock No.	Description	Price
334234	Nitro Adhesive Gun	\$79.99
334235	Nitro Adhesive Static Mixing Tip	1.16

nitro ONE SHOT

200 COLORS AVAILABLE



Pneumatic Adhesive Gun

For use with cartridge adhesives. With an adjustable heavy duty aluminum air regulator and air dump valve that stops flow immediately. Easily converts in seconds with snap in/ snap out push disc for mix ratios of 1:1, 2:1, and 10:1.

- Nominal thrust of 490 lbs @ 100 psi
- For use with 250ml & 500m adhesive cartridges
- Quick-disconnect nipple Included
- Slide in side load



Stock No.	Description	Price
310164	Pneum. Adhesive Gun	\$399.99

Diarex® Seam Release Heat Pad

Pad heats up to help release adhesive on misaligned seams.

- 50-425F° Temperature range
- 4" Wide, 29" heating area
- 4.5AMP 120V 550Watt



Stock No.	Description	Price
500128	4" Wide Pad	\$341.99

Touchstone Colorant Sets

- 10 Colors available
- 2 oz. bottles



Stock No.	Description	Price
100375	Color Set	\$78.95



Touchstone Colorants

- 10 Colors available
- Choose 2 oz or 8 oz. bottles

	Stock No.	Color/Size	Price		Stock No.	Color/Size	Price
8 Oz. Bottles	900426	White, 8oz.....	\$24.95	2 Oz. Bottles	900517	Red, 2 oz.....	\$7.95
	900427	Blue, 8oz.....	24.95		900518	Blue, 2 oz.....	7.95
	900428	Red/Brown, 8oz.....	24.95		900643	Brown, 2 oz.....	7.95
	900429	Yellow, 8oz.....	24.95		900644	Red/Brown, 2 oz.....	7.95
	900430	Black, 8oz.....	24.95		900645	Black, 2 oz.....	7.95
	900431	Brown, 8oz.....	24.95		900646	Yellow, 2 oz.....	7.95
	900432	Green, 8oz.....	24.95		900647	White, 2 oz.....	7.95
	900433	Red, 8oz.....	24.95		900648	Buff, 2 oz.....	7.95
	900502	Gray, 8oz.....	24.95		900822	Green, 2 oz.....	7.95
	900503	Buff, 8oz.....	24.95		900854	Gray, 2 oz.....	7.95

Tenax Universal Color Kit

Tenax polyester colors can be used with polyester adhesives. Tenax polyester coloring kit contains one tube each of black, white, red, red-brown, yellow, green, brown, blue, gray and buff. Unlimited color matching on polyester & epoxy adhesives.



Stock No.	Description	Price	Stock No.	Description	Price
923242	10 Pc. Kit	\$74.95	923256	Baltic Brown, 2.5 oz.....	\$8.95
923243	Black, 2.5 oz.....	7.95	923257	UbaTuba, 2.5 oz.....	8.95
923244	White, 2.5 oz.....	7.95	923258	Black Galx, 2.5 oz.....	8.95
923245	Red, 2.5 oz.....	7.95	923259	Black, 10 oz.....	23.95
923246	Red-Brown, 2.5 oz.....	7.95	923260	White, 10 oz.....	23.95
923247	Yellow, 2.5 oz.....	7.95	923261	Red, 10 oz.....	23.95
923248	Green, 2.5 oz.....	7.95	923262	Red-Brown, 10 oz.....	23.95
923249	Brown, 2.5 oz.....	7.95	923263	Yellow, 10 oz.....	23.95
923250	Blue, 2.5 oz.....	7.95	923265	Brown, 10 oz.....	23.95
923251	Gray, 2.5 oz.....	7.95	923267	Gray, 10 oz.....	23.95
923252	Buff, 2.5 oz.....	7.95	923268	Buff, 10 oz.....	23.95
923253	Gial Ven, 2.5 oz.....	8.95	923270	Santa Cec, 10 oz.....	24.95
923254	Santa Cec, 2.5 oz.....	8.95	923273	UbaTuba, 10 oz.....	24.95
923255	Blue Pearl, 2.5 oz.....	8.95	923274	Black Galx, 10 oz.....	24.95

6" Plastic Adhesive Spreader

Semi-rigid construction with enough flex for even spreading over any surface.

- Tapered for smooth feathering
- Spread adhesive, seam sealers, caulking and more

Stock No.	Price
692739	35¢ Ea.





LIFT Tacker Glove

Heavy duty, genuine leather gloves designed for superior abrasion resistance.

- Machine washable
- Padded palm for impact & vibration absorption.

Stock No.	Color / Size	Price
103724	Gray - Large	\$33.60
103725	Gray - X-Large	33.60
103726	Gray - 2X-Large	33.60
103727	Black - Large	33.60
103728	Black - X-Large	33.60
103729	Black - 2X-Large	33.60
103730	Camo - Large	33.17
103731	Camo - X-Large	33.17
103732	Camo - 2X-Large	33.17



LIFT Cut 5 Impact Glove

Offers FiberWire™ cut level 5 protection covering the entire hand.

- Fullback of hand protection reduces hand injuries
- Etched latex palm provides superior grip on wet and oily surfaces.

Stock No.	Size	Price
103721	Medium	\$18.99
103722	Large	18.99
103723	X-Large	18.99



LIFT 8 Seconds Top Grain Glove

Durable yet comfortable top grain cowhide leather glove that offers superior abrasion resistance.

- Keystone thumb design for increased dexterity and tactility.

Stock No.	Size	Price
103737	Medium	\$10.49
103738	Large	10.49
103739	X-Large	10.49



LIFT Palmer Micro Foam Glove

- Lightweight, low profile glove with a breathable polyester shell.
- Thin foamed nitrile palm offers super grip and tactility.

Stock No.	Size	Price
103734	Medium	\$5.24
103735	Large	5.24
103736	X-Large	5.24



Bioskin Gloves

Powder-free Bioskin latex gloves are medical grade, 100% latex and are extra thick (14 mil) which reduces the chances of ripping or tearing.

- 50 gloves to a box
- ISO 9001 approved

Stock No.	Size	Price
340008	Large	\$14.25
340156	X-Large	14.25



Nitri-Solve 26" Long Chemical Resistant Gloves

Durable, chemical-resistant gauntlet style glove made of dipped nitrile over a cotton liner. Protects the hands and arms from a wide range of chemicals.

- Elastic band and grommet holds gloves to arm

Stock No.	Size/Desc.	Price
000139	Size 9, One Pair	\$19.95
000140	Size 10, One Pair	19.95

Onyx® Nitrile Gloves

Powder-free black nitrile gloves are ideal for working in wet and messy environments. Nitrile construction with textured finish for chemical resistance and a great grip.

- 9.6" Length, medical/exam grade gloves

Stock No.	Size/Desc.	Price
600199	Large, One Pair	\$14.10
600209	Extra Large, One Pair	14.10

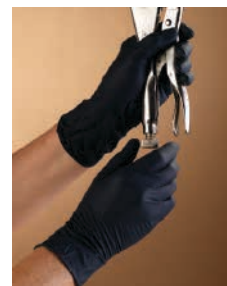

Ansell Hyflex Gloves

Ergonomically designed gloves are made with Dyneema® and Lycra® liner with a polyurethane palm coating for cut and snag resistance.

Stock No.	Size	Price
340381	Large	\$15.45
340382	X-Large	15.45



Knit Gloves w/Rubber Palm

Rubber latex palm coating offers improved abrasion resistance and grip for lifting and handling heavy/rough objects.

Stock No.	Size	Price
340354	Medium	\$1.99
340355	Large	1.99
340356	X-Large	1.99



Ninja®Ice Nylon Work Gloves

Feature a 15 ga. black nylon shell & 7 ga. acrylic terry interior liner for great protection while allowing excellent dexterity and sense of touch.

Stock No.	Size	Price
057150	Medium	\$8.49
057151	Large	8.49
057152	X-Large	8.49



Latex Disposable Gloves

- 5mil, Size: Large
- 100 Gloves per box

Stock No.	Color	Price
340014	Cream	\$7.35
340015	Green	14.27



Latex-Free Blue Nitrile Disposable Gloves

A 6mil thick, low-cost alternative for people who have latex allergies. Soft, pliable and durable nitrile.

- Nitrile material provides a durable barrier to chemicals and other biohazards

Stock No.	Size/Qty.	Price
001110	Med., 100 Ct.	\$13.95
696164	Large, 100 Ct.	13.95
340199	X-Large, 100 Ct.	13.95

GranQuartz
DIAREX®



**Diarex®
Stir Stix™**

- Innovative design- flat scraping end and round stirring end

Stock No.	Description	Price
340042	Box of 500.....	\$12.54

GranQuartz
DIAREX®



**Diarex®
Mixing Cups**

- Sleeve of 50 disposable paper mixing cups

Stock No.	Price
100499.....	\$6.79



**All Purpose
Shop Wipes**

- Box of 200 10 x 14" sheets
- Cloth-like performance, disposable
- Handy dispenser box

Stock No.	Description	Price
340071.....	200 ct. box.....	\$15.75



Primo™ Wipes

Primo Wipes are solvent-resistant, not affected by acetone or denatured alcohol and are tough, durable & reusable!

- Box of 400, size of sheets varies (9 x 15" - 16 x 16")
- Lint-free

Stock No.	Description	Price
005945.....	8 Lb.Box.....	\$39.99



Terry Cloth Rags

Stock No.	Description	Price
340045	10 lb. box.....	\$24.45
340046	25 lb. box.....	61.85

Cotton T-Shirt Rags

Stock No.	Description	Price
340047	10 lb. box.....	\$23.90
695983	25 lb. poly bag.....	59.15

**T-Rex®
Black Duct Tape**

Aggressive double-thick adhesive and 3 distinct material layers combine to create this weather-resistant, extremely strong tape. Sticks to rough, dirty surfaces including stone, brick, concrete, and most other painted or un-painted surfaces.

- UV resistant materials
- Waterproof, 17 mil thick 3-Ply material for long lasting repairs

Stock No.	Width/Length	Price
152510	1.8"x 35 yds.	\$13.10



**Shurtape®
CP27 Blue Tape**

14 Day ShurRELEASE removes cleanly from surface.

- Clean removal
- Low adhesion
- Blue crepe backing

Stock No.	Width/Length	Price
340061	2'x 60 yds.....	\$8.99
340178	1'x 60 yds.....	4.99



**Industrial
Masking Tape**

Stock No.	Width/Length	Price
340059	1"x 60 yds.....	\$2.35
696368	1 1/2" x 60 yds...	3.25
340060	2"x 60 yds.....	3.47



**Alpha®
G- Tape**

- Waterproof, repositionable
- Great for quick repairs
- Hard surface protection
- Weather and UV resistant

Stock No.	Width/Length	Price
011009	2'x 60 yds.....	\$15.99



FillaChip UV Scratch & Chip Repair Kit

Starter Kit includes UV flashlight, 4 syringes with 3ccs of FillaChip glue, 10 dispensing tips and 8 plastic release sheets. Refill Kit includes 4 syringes with 3 ccs of glue, 10 tips and 8 release sheets. Great for jobsite touch-ups.

Stock No.	Description	Price	Stock No.	Description	Price
681743	Master Repair Kit.....	\$550.00	359327	Grey Vein Syringe w/Fillachip Polish.....	29.50
681772	Large Release Sheets, 8" x 3".....	1.00	681770	Off White Syringe w/Fillachip Polish.....	29.50
681744	Fillachip Standard UV Flashlight.....	13.50	681768	Light Grey Syringe w/Fillachip Polish.....	29.50
359321	Fillachip Large UV Flashlight.....	34.50	681763	Translucent Creme Syringe w/Fillachip Polish.....	29.50
681773	Clear Syringe w/Purple Tip.....	13.00	359328	Concrete Syringe w/Fillachip Polish.....	29.50
359320	Polish Syringe.....	12.95	681765	Translucent Brown Syringe w/Fillachip Polish.....	29.50
359324	Super White Syringe w/Fillachip Polish.....	29.50	681766	Medium Brown Syringe w/Fillachip Polish.....	29.50
359323	Translucent White Syringe w/Fillachip Polish.....	29.50	681764	Dark Creme Syringe w/Fillachip Polish.....	29.50
359325	Translucent Black Syringe w/Fillachip Polish.....	29.50	681767	Dark Brown Syringe w/Fillachip Polish.....	29.50
359326	Super Black Syringe w/Fillachip Polish.....	29.50	359329	UbaTuba Syringe w/Fillachip Polish.....	29.50

**Stonelux ECO
Stone Repair Kit**

Complete system for repairs to granite, marble and engineered stone surfaces. Uses m3 light device with a hardening time of 5 minutes per exposure area.

- Includes UV light
- White, black & transparent adhesives
- Primer pen, tips and plastic foil (for flattening adhesive to surface)
- Polishing paste & sandpaper for final polish

Stock No.	Description	Price
102920	ECO Repair Kit.....	\$162.50

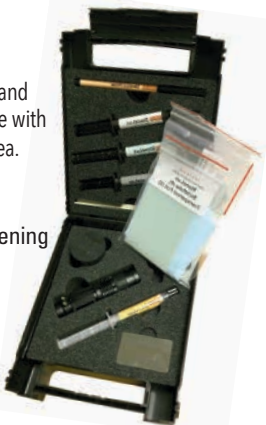

FillaChip Master Repair Kit

For repairs of all colors of stone. The Master Kit includes 19 color syringes, 2 clear syringes, 2 polish syringes, 1 large and 1 small curing flashlight, 30 tips, 30 release sheets, plastic container for razor blades, and a dremel tool. Colors are mixable for a perfect match.

- Excellent Results
- Great for Jobsite Touchups

Stock No.	Description	Price
681745	Starter Kit.....	\$99.50
681746	Refill Kit.....	49.50



Surebonder® Cordless Glue Gun

The Surebonder Hybrid 120 glue gun runs on battery or corded power. There are also 3 battery adaptors available that can accommodate slide-on batteries for DeWalt 20V, Milwaukee and Makita 18V batteries respectively.

- Precision nozzle for easy application
- Light weight (only 1.3 lbs)
- 125 Watts for high output
- Up to 3 hr. run time
- FAST heat up (90 sec.)

Stock #	Description	Price
700171	... Glue Gun, Case & Cord.....	\$82.95
700172	... Glue Gun, Case, Cord & Battery....	221.95
700173	... Battery Adapter for Milwaukee 18V..	19.95
700174	... Battery Adapter for Makita 18V.....	19.95
700175	... Battery Adapter for Dewalt 20V.....	19.95



Hot Glue Gun

- 6 foot cord
- 200 WATT
- Comfort grip

Stock #	Price
350108	\$49.95

GranQuartz® 600 Cordless Hot Melt Glue Gun

- Butane powered, 90 minute runtime per cartridge
- Warms up in 5 minutes
- Output of 3.3 lbs of glue per hour
- Thermostatically controlled
- Full-hand ergonomic trigger and handle
- Kit includes GranQuartz 600 glue gun, heavy duty case, 2 cartridges & 1 lb. hot melt adhesive sticks



Stock Number	Description	Price
350110 Cordless Glue Gun.....	\$129.95
350111 Glue sticks, 11 lb. box	67.00
350112 Butane cartridges, 3 pack.....	34.95

Hot Glue Sticks

- 1/2" x 10"
- Extended set time (60-80 seconds), rapid set time & 30-40 second set time glue sticks available

Stock No.	Description	Price
695558	4 Lb. Bag (63 sticks) 1/2" x 12"	\$16.59
350102	Extended Set Time (60-80 sec), 25 lbs.....	150.75
350105	Extended Set Time, 20 Pack	9.95
350104	30-40 Seconds Set Time, 25 lbs.	150.75
350107	30-40 Seconds Set Time, 20 Pack.....	10.39
350103	Rapid Set Time, 25 lbs.....	144.95
350106	Rapid Set Time, 20 Pack	8.70

GranQuartz
DIAREX®



Diarex® Quick-Set Anchor Adhesives Acrylic or Epoxy

Works great with our adhesive bonded anchors & adhesive bonded dishwasher anchors.

Stock No.	Description	Price
900775	Acrylic 25ml Cartridge.....	\$10.95
900776	Acrylic 50ml Cartridge.....	18.05
900777	Epoxy 25ml Cartridge	8.15
900778	Epoxy 50ml Cartridge	15.05
900779	50ml Static Mixing Tip	1.00
900396	50ml Dispensing Gunw/Plunger	22.85



Touchstone Easy-Mix Dispenser

Heavy duty, steel dispenser precisely pumps the required 2 to 1 mix ratio of Touchstone Edge System or Penetrating Epoxy.

- On-board heating element allows faster setting times

Stock No.	Price
900460	\$611.95



Scrim Cloth/Roll

Slab and countertop mesh reinforcement.

- 38" x 150' rolls

Stock Number	Price
800499	\$134.95

Pump for 5 Gallon Pail

- Fits most 5 gallon pails
- Prevents contamination
- Extends shelf life



Stock No.	Price
900479	\$99.95



450ml Manual Cartridge Gun

- For use with Touchstone Ratio-Pac
- Built-in cartridge stabilizing plate
- Smooth in-line drive and hex push rods

Stock No.	Price
900446	\$104.95



Standard Caulk Gun

- Non-drip 10.3 oz. cartridge capacity
- Steel frame
- 14:1 Thrust ratio
- Spout cutter, seal puncture tool

Stock Number	Price
200499	\$7.70



50ml Manual Cartridge Gun

- For use with Touchstone Edge System or Diarex Quick-Set
- Includes 2-1 or 1-1 mixing plunger

Stock No.	Description	Price
900396	Gun, 1-1 plunger	\$22.85

Pro Series® Acrylic/Latex Caulk

Pro Series® Acrylic Latex is a premium grade multi-purpose caulk that is engineered to deliver excellent adhesion and durability.

- Environmentally Friendly
- Easy Gunning & Tooling
- Cleans Up with Water
- Paintable White Color



Stock No.	Description	Price
103212	Acrylic/Latex Caulk, White	\$1.80/tube
200580	Acrylic/Latex Caulk, Clear	2.69/tube

Pro Series® Silicone Caulk



Pro Series® is a flexible caulk with a rubber-tight seal providing superior adhesion to non-porous surfaces. Easy to work and quick setting with excellent gunability. Dries to a smooth finish.

- Durable 50 year life expectancy
- High performance, flexible caulk



Stock No.	Color	Price
200560	Clear	\$4.52/tube
200559	Translucent	5.43/tube
698213	Almond	5.43/tube
698214	Black	5.43/tube
698215	White	5.43/tube



Dripless® ETS2000 Caulk Gun

Reduces hand fatigue to make caulking jobs a snap.

- Rotating barrel
- Sharp precision cutter
- Extra long clean-out

Stock No.	Price
200222	\$14.25

Caulk-EZ® Caulk Conditioner

Caulk conditioner/sealer for a perfect bead with no mess.

- One can covers up to 8 ten oz. tubes of caulk

Stock Number	Price
200561	\$8.29



Black Mamba FHG Silicone Caulk



Installing a sink in 10 seconds with Black Mamba FHG. Black Mamba is made of monocomponent MS polymer adhesives which react with the humidity in the air for optimal sealing even under pressure.

- Very fast sealing caulk
- Resistant to water, UV exposure, yellowing

Stock No.	Color	Price
200567	Grey	\$12.90/tube
200568	White	12.90/tube
200569	Black (Special Order)	12.90/tube
200566	Replacement Tip	.95/ea.



Sir-O-Sil® 25 Silicone Sealant & Adhesive

High Performance, one component, acetoxy cure silicone sealant and adhesive.

- Cures to a durable, flexible, silicone rubber
- Designed for fast curing and excellent adhesion to non-porous surfaces
- Accommodates joint movement of +/- 25%
- Highly resistant to uv light, ozone, moisture and extreme temperature variations



Stock No.	Description	Price Each
200490	Clear (#4000), 10 per case	\$4.95
200491	White (#4001), 10 per case	4.95

Duo-Sil® Acrylic Sealant & Adhesive

High Performance, one component, urethane acrylic sealant and adhesive.

- Fill butt joints in countertops, showers, windows, and most areas where a sealant is needed
- Bonds to wood, metal, gypsum board and most other surfaces
- Flexible, will not crack or fade
- Soap & water cleans-up
- Available in 20 colors
- 10.3 fl. oz. plastic cartridges (12 cartridges per case)



Stock No.	Color/Color #	Price	Stock No.	Color/Color #	Price
200400	White (#2001)	\$4.97	200410	Beige (#2429)	\$4.97
200401	Clear (#2000)	4.97	200411	Almond Beige (#2435)	4.97
200402	Black (#2003)	4.97	200412	Antique White (#2448)	4.97
200403	Bronze (#2201)	4.97	200413	Charcoal Gray (#2501)	4.97
200404	Musket Brown (#2203)	4.97	200414	Silver Ash (#2502)	4.97
200405	Terra Bronze (#2219)	4.97	200415	Silver Birch (#2513)	4.97
200406	Doeskin (#2411)	4.97	200416	Monterey Red (#2901)	4.97
200407	Palomino Beige (#2415)	4.97	200417	Chestnut (#2924)	4.97
200408	Taupe (#2417)	4.97	200418	Wheat (#2926)	4.97
200409	Almond Cream (#2427)	4.97	200419	Village Green (#2932)	4.97



Polyseamseal All-Purpose Adhesive Caulk

Premium grade Polyvinyl Acetate (PVA) based product, designed to have the strength of an adhesive and the sealing characteristics of a caulk. Polyseamseal is perfect for seaming granite kitchens and marble vanities.

- Cleans up with water and soap; paintable in 2 hours, depending on temperature and humidity
- Adheres to granite, marble, wood, metal, ceramics, vinyl, porcelain and fiberglass
- Sold in cases of twelve 10 oz. tubes
- Resists Mold and Mildew

Stock No.	Color	Price/Case
340075	White	\$3.92/47.04
340076	Almond	3.92/47.04
340078	Clear	4.22/50.64

313P Premium Water Based Impregnator

313P Premium Impregnator is water based and offers protection from both oil and water borne stains. 313P is easy and safe to use, has no smell and may be used for interior and exterior applications, on polished and unpolished surfaces. Ideal for all stone kitchen counter tops, bathrooms, furniture and floors (not recommended for polished marble). Covers 100 to 200 sq. feet per quart depending on porosity of stone.



Stock No.	Unit	Price Ea.	Case Price/Qty.
100189	1 Quart.....	\$47.24.....	\$425.16/10
100176	5 Liters.....	219.07.....	394.33/2

314P Premium Impregnator

314P Premium Impregnator is a silicone impregnator suitable for use on all natural stones regardless of finish type. 314P provides the highest quality stain protection available for both interior and exterior applications. Obtain maximum protection from oil and water borne stains. 314P allows the stone to breathe naturally, cures quickly and offers a natural appearance. Covers 100 to 300 sq. feet per quart depending on porosity of stone.



Stock No.	Unit	Price Ea.	Case Price/Qty.
100182	1/2 Liter.....	\$29.75.....	\$267.75/10
100183	1 Quart.....	49.00.....	441.00/10
100186	5 Liters.....	232.43.....	418.37/2
100184	10 Liters.....	431.20.....	776.16/2

353P Porous Stone Impregnator

353P Porous Stone Impregnator offers maximum protection from water borne stains for porous stone. 353P is a silicone impregnator specifically formulated for honed and textured stone and is also excellent for masonry surfaces and unglazed clay tiles. Used for both interior and exterior, 353P allows the stone to breathe naturally, cures quickly, offers a totally natural appearance and requires no special equipment to apply. Covers 50 to 150 sq. feet per quart depending on porosity of stone.

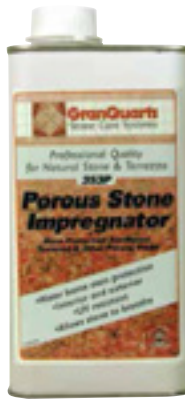

Stock No.	Unit	Price Ea.	Case Price/Qty.
100195	1 Quart.....	\$29.31.....	\$263.79/10
100197	5 Liters.....	122.40.....	220.32/2

413S Professional Impregnator

413S Professional Impregnator is a highly effective silicone impregnator designed for the Stone Professional. 413S is fast and easy to apply, cures quickly and offers the ultimate in long term stain protection on all stone surfaces. 413S is UV resistant and leaves the stone looking completely natural. Covers 150 to 200 sq. feet per quart depending on porosity of stone.



Stock No.	Unit	Price Ea.	Case Price/Qty.
100214	1/2 Liter.....	\$20.50.....	\$184.50/10
100215	1 Quart.....	29.34.....	264.06/10
100218	5 Liters.....	122.34.....	220.21/2
100216	10 Liters.....	205.63.....	370.13/2

357E Stone Sealer/Color Enhancer-Gloss Finish

357E Stone Sealer/Color Enhancer-Gloss is a modified acrylic sealer/color enhancer for use on textured stone only. 357E cures to an ultra hard, durable finish that enhances the natural appearance of the stone with a satin gloss and protects it from oil, grease and mineral deposits. For interior use only, use 357E to enhance color. 357E is UV resistant and allows the stone to breathe naturally. Covers 75 to 175 sq. feet per quart depending on porosity of stone.



Stock No.	Unit	Price Ea.	Cs Price/Qty.
100202	1 Quart.....	\$34.87.....	\$313.83/10
100204	5 Liters.....	157.20.....	282.96/2

355E Color Enhancing/Impregnator Matte Finish

355E Color Enhancing/Impregnator-Matte Finish is a color enhancing silicon impregnator for honed and textured stone only. 355E's high degree of protection enhances the natural appearance of stone without gloss and protects it from water based stains and mineral deposits. 355E is UV resistant and allows the stone to breathe naturally. Covers 75 to 150 sq. feet per quart depending on porosity of stone.



Stock No.	Unit	Price Ea.	Cs Price/Qty.
100199	1 Quart.....	\$36.61.....	\$329.49/10
100201	5 Liters.....	142.98.....	257.36/2



Superior

Superior® FIRE Color Enhancer

Enhances the natural color and brilliance of exotic stone surfaces.

- Fast acting, easy to apply
- VOC Compliant
- Creates a "Wet" look

Stock No.	Unit	Price
104474.....	1 Quart.....	\$76.95



Superior

Superior® LIGHTNING Color Enhancer

Enhances the natural color and brilliance of Engineered Stone surfaces.

- Provides additional stain protection
- VOC Compliant
- Creates a "Wet" look

Stock No.	Unit	Price
104475.....	1 Quart.....	\$68.95



Superior

Superior® ICE Color Enhancer

ICE enhances the natural color and brilliance of stone and provides a "wet" look with no harsh odors.

- Ideal for matching edge profiles
- Provides stain protection
- Fast action + easy to use

Stock No.	Unit	Price
690274.....	1 Quart.....	\$60.95



Pro Series® Stone Color Enhancer

Creates an aging or wet look on natural stone, suitable for all natural stone regardless of finish type. Fully cured within 1 hour. Treated surface is water-repellent within 24 hrs, suitable for indoor/outdoor applications.

Stock No.	Unit	Price
117342	1 Liter.....	\$60.95



Tenax® Proseal Premium

Tenax Proseal is suitable to protect granite against liquid chemicals like beverages and similar liquids without affecting the color of the surface. Works well with polished, honed, marble with high porosity. Proseal fills the pores of the stone and protects the stone from oil and water stains.

- Great on Granite, Limestone, Sandstone, Terrazzo, Concrete & Engineered Stone

Stock No.	Unit	Price
923296	.25 Liter.....	\$15.95
900000	1 Quart.....	37.95
900001	5 Liters.....	198.70



Tenax® Tepox Q UV Resistant

Tepox Q is a special chemical color liquid used to color match stones that have been resined with color additives. Tepox Q may also be used to enhance slabs or to alter the look of a slab for specific applications. Use a single color or mix multiple colors together to achieve the desired effect. Tepox Q is designed to be used in conjunction with Ager or Ager Tiger and is suitable for indoor and outdoor use.

Stock No.	Description	Price	Stock No.	Description	Price
825067	250ML Color Kit, 1 ea. of 6 Colors.....	\$105.95	200570	White Tint, 1 Liter.....	\$72.85
200126	Brown Tint, 250ML.....	21.65	200571	Black Tint, 1 Liter.....	72.85
200127	Black Tint, 250ML.....	21.65	200572	Green Tint, 1 Liter.....	72.85
200128	Marine Blue Tint, 250ML.....	21.65	200573	Yellow Tint, 1 Liter.....	72.85
200129	Bordeaux Tint, 250ML.....	21.65	200574	Brown Tint, 1 Liter.....	72.85
200130	Esmeralda Green Tint, 250ML.....	21.65	200575	Red Tint, 1 Liter.....	72.85
200131	Iron Tint, 250ML.....	21.65	200576	Botticino Tint, 1 Liter.....	72.85
200132	Red Tint, 250ML.....	21.65	200578	Blue Brilliant Tint, 1 Liter.....	72.85
200133	Yellow Tint, 250ML.....	21.65	200592	Bianco Tint, 1 Liter.....	72.85
200134	Ferrato Tint, 250ML.....	21.65			
200459	Coliseum Tint, 250ML.....	21.65			
200577	Blue Rio Tint, 250ML.....	21.65			



Tenax® Hydrex Sealer

Hydrex is a penetrating sealer that prevents liquids (stains) from penetrating into the material and allows the stone to breathe to maintain its natural characteristics. Hydrex works great on polished granite and polished marbles, will not change the color of the stone.

- Use for indoor or outdoor applications

Stock No.	Unit	Price
923299	.25 Liter.....	\$9.95
693734	1 Quart.....	26.95
691144	5 Liters.....	81.95



Tenax® Protex Sealer

Tenax Protex is one of the top premium sealers on the market today. Protex is suitable for the treatment of all types of stone. Works extremely well on sandy amorphous material mixed with the presence of silicate and calcium carbonate.

- Great on Granite, Limestone, Sandstone, Terrazzo, Concrete & Engineered Stone Surfaces

Stock No.	Unit	Price
691143	1 Quart.....	\$68.95



Tenax® Pectro

Pectro hides micro fissures and spider web cracks. Available in clear and black. For polished granites. For indoor and outdoor application.

Stock No.	Desc.	Unit	Price
117275	Clear.....	1 Liter.....	\$31.95
171025	Black.....	1 Liter.....	31.95



Tenax® Quarzo Quartz Toner PLUS

Perfect for bringing out the deep rich color in polished quartz and engineered stone surfaces, works well to disguise surface small scratches.

- Approved for use on surfaces in contact with food
- Color enhancer & premium grade sealer
- 1 Liter container covers approximately 215-300 sq. feet

Stock No.	Desc.	Unit	Price
923328	Quarzo Plus.....	1 Liter.....	\$66.65



NEW!



Akemi® Transformer Enhancer/Sealer

Akemi Transformer Enhancer is a color enhancing sealer, suitable to enhance, darken and bring out the natural color of any stone and protect it from some stains. Transformer is also used to color match the edges of finished granite countertops that have been treated with a darker resin epoxy surface.

Stock No.	Description	Price
359455	1 Liter, Transformer Enhancer/Sealer	\$64.95

NEW!



Akemi® Transformer Exotic/Sealer

Akemi Transformer Exotic is a stone enhancer and impregnator used to intensify the color of natural stone and quartz stone. Transformer Exotic is recommended on the edges of resined stones and granites, especially exotic stone when needed to match the edge of the stone to the resin treated top.

Stock No.	Description	Price
359456	1 Liter, Transformer Exotic/Sealer.....	\$89.95

NEW!



Akemi® Darkener Super Impregnator

Akemi Darkener Super is a food-safe solvent-based special impregnator, containing reactive modified silicates. Akemi Darkener Super is perfect for concealing scratches and imperfections on darker-colored stones. Use Akemi Darkener Super Stone Enhancer indoors or outdoors on all finishes to intensify the natural color without leaving residue.

Stock No.	Description	Price
359417	1 Liter, Darkener Super Impregnator	\$59.95
359419	5 Liters, Darkener Super Impregnator	213.95

NEW!



Akemi® Darkener Plus

AKEMI Darkener Plus Coloring Kit transports the AKEMI Stone Ink dye into the stone's pore system for a long-lasting effect. AKEMI Stone Ink can be used to intensify the color of the stone surface or to alter the color shade. For color adjustment, darkener plus must be mixed with darkener ink.

Stock No.	Description	Price
359425	1 Liter, Darkener Plus.....	\$73.95
359460	Darkener Plus Kit, 6 Colors (50ml each)...	199.95

NEW!



Akemi® Stone Impregnation Remover

Akemi Stone Impregnation Remover is designed to be used for the removal of penetrating impregnators, sealers or enhancers.

Stock No.	Description	Price
359434	1 Liter, Stone Impregnation Remover....	\$49.95





Tenax® Uniblack 1

Uniblack 1 is used for diminishing the defects which are sometimes apparent in polished black granite. Application darkens the surface of the material and makes it more homogeneous. Quick drying.

Stock No.	Unit	Price
200484	1 Liter.....	\$33.95

Tenax® Uniblack 2

Uniblack 2 is a black liquid wax used to increase the black effect on polished, brushed and smooth surfaces. The Uniblack 2 increases the black effect without increasing the gloss.

Stock No.	Unit	Price
200485	1 Liter.....	\$33.95



Bellinzoni® Idea Gold Stain Protector

Idea Gold is an exceptional stain protector based on nanotechnology formulation that protects marble and granite from a wide range of stains including water, oil, and fats. Bellinzoni Idea Gold works great on polished surfaces, blocks efflorescence and penetrates deep without changing the natural color of stone surfaces.

- Allows stone surfaces to breathe
- 1 Liter container
- Safe for use on surfaces in contact w/food

Stock No.	Unit	Price
103373	1 Quart.....	\$58.95



Tenax® Ager

Ager is suitable for aging all types of marbles, travertines, stone, granites and agglomerates.

- For indoor and outdoor use
- Produces a "wet" effect

Stock No.	Unit	Price
172347	1 Pint.....	\$20.49
200470	1 Quart.....	66.25
693730	5-Liter.....	309.00



Tenax® Tiger Ager

Tiger Ager is formulated to produce a "wet effect" on the more exotic colors of stone surfaces, travertines, and agglomerates.

- For indoor and outdoor use

Stock No.	Unit	Price
171247	1 Quart.....	\$96.85



Tenax® Ager Remover

Removes excess Ager left on the surface by over-application or by allowing Ager or Ager Tiger to dry on the surface.

- Transparent in color
- Eliminates sticky, tacky residue by over-use of Ager or Ager Tiger

Stock No.	Unit	Price
200487	1 Liter.....	\$33.40



Stone Tech Impregnator Pro™ Sealer

Heavy duty stain solvent-based protector for all natural stone. Preserves natural look. Protects against oil and water-based stains. For interior and exterior use.

Stock No.	Unit	Price
695684	1 Quart.....	\$48.95
695687	1 Gallon.....	144.95



Stone Tech BulletProof™ Sealer

Maximum protection against the toughest oil and water-based stains. New, advanced formula bonds with stone for improved wear resistance.

Stock No.	Unit	Price
693705	1 Quart.....	\$60.95
693706	1 Gallon.....	176.95
693707	5 Gallon.....	675.95

Stone Tech Revitalizer™

Cleaner and surface refresher available in either Cucumber scented or Citrus scented.

- Built in sealer
- Gentle formula

Stock No.	Description	Scent	Price
697914	Ready to Use Gallon.....	Citrus.....	\$26.95
697915	Concentrate Gallon.....	Citrus.....	45.95
697916	24 oz. Bottle.....	Cucumber.....	13.95
697917	24 oz. Bottle.....	Citrus.....	13.95





Miracle Sealant 511 Impregnator Sealer

511 Impregnator is the original penetrating sealer designed for the protection of all medium to dense porous surfaces. 511 forms an invisible barrier that is resistant to moisture and stains while allowing vapor to escape. 511 is not a surface coating and will not alter the natural look. All surfaces treated are harder and less slippery.

- Superior Coverage
- For indoor and outdoor use
- Suitable for use in food preparation areas
- Excellent coverage

Stock No.	Description	Price
118103	1 Quart, 511 Impregnator	\$27.95
600239	1 Gallon, 511 Impregnator	91.83



Miracle Sealant 511 Porous Plus Sealer

511 Porous Plus is a penetrating sealer designed for the protection of the most porous surfaces. 511 forms an invisible barrier that is resistant to moisture and stains while allowing vapor to escape. 511 Porous Plus is not a surface coating and will not alter the natural look. Surfaces are harder and less slippery after use.

- Superior Coverage
- Coverage: approx. 500 - 2,000 sq. feet per gallon on most porous surfaces
- For indoor and outdoor use
- Suitable for use in food preparation areas
- Excellent coverage

Stock No.	Description	Price
118109	1 Quart, 511 Porous Plus	\$59.95
106318	1 Gallon, 511 Porous Plus.....	199.95



Miracle Sealant 511 Seal & Enhance

511 Seal & Enhance is a unique solvent-based formula that eliminates the need for using an impregnator before applying a color enhancer. 511 enhances the color and rejuvenates the appearance of tumbled, honed, acid-washed, sandblasted, flamed, textured, even polished stone and tile surfaces.

- Revitalizes worn surfaces
- Coverage: approx. 250 - 4,000 sq. feet per gallon
- Superior Coverage
- For indoor and outdoor use
- Oil resistant and water repellent
- Lasts for 3-5 years

Stock No.	Description	Price
600749	1 Quart, 511 Seal & Enhance	\$54.04

CLEANING PRODUCTS & CHEMICALS

GranQuartz 113M 3-in-1 Cleaner, Polisher and Protector Spray

Perfect for everyday use, GranQuartz 113M spray is formulated to keep natural and engineered stone surfaces including granite, marble, quartz, limestone, travertine, Corian®, Silestone®, ceramic and porcelain sparkling clean and looking brand new. 113M conditions natural stone surfaces to restore, maintain and enhance their reflective luster and beautiful rich colors. Regular use of 113M makes surfaces easier to clean and leaves a water-resistant protective coating to safeguard against spills, hard water dark spots and etching.

- Non-toxic, biodegradable
- Non-acidic neutral and gentle non-abrasive formula
- Fresh lemony scent
- Leaves a pleasant velvety surface touch
- No buildup, streaks, residues or greasy film
- Resists fingerprints and smudges, prolonging your stone's reflective properties
- Also cleans, polishes and preserves the high luster of stainless steel, aluminum, brass or chrome appliances, faucets or fixtures



Stock No.	Unit	Price Ea.	Case Price/Qty.
100019	16 oz.	\$16.99	\$140.30/12

113M Private Label Program

Now you can offer 113M to your customers under your own private label.

- Minimum opening order and reorder is 25 cases each
- A one time art fee of \$185 (full color label) is charged
- Shipping is FOB from Missouri

Call (800) 458 6222 for detailed information and pricing.



Tenax® TeRust Rust Remover

TeRust Rust Remover Powder is formulated with a proprietary blend of chelates for rust removal on natural stone surfaces.

- Draws Stain from Stone Surface
- Effective rust removal in 24- 48 hours
- 8 oz. Container

Stock No.	Unit	Price
171357	8 oz.	\$12.25



214M Daily Conditioner/Cleaner

214M is a 100% natural, pH neutral conditioning cleaner that is safe for all stone and ceramic surfaces. Daily damp mopping with 214M maintains the stone's natural patina. Regular use helps to create a slip retardant, scuff resistant, buffable and dust repellent surface, while remaining completely undetectable on the surface.

- Great for auto scrubber use
- Coverage: 8,000 to 12,000 sq. feet per liter

Stock No.	Unit	Price Ea.	Case Price/Qty.
100088	1 Liter	\$17.91	\$161.19/10
100091	5 Liters	74.73	134.51/2



725C Granite Cleaner/Rust Inhibitor

A heavy duty, acid based cleaner for use on flamed or otherwise textured granite and other non polished natural stones. 725C quickly removes grout and mortar residues, lime and hard water mineral deposits, efflorescence, surface rust and heavy construction dirt. Rust inhibitor helps control future rust. For indoor and outdoor applications. Coverage: 200 to 300 sq. feet per liter.

Stock No.	Unit	Price Ea.	Cs Price/Qty.
100262	1 Liter	\$23.80.....	\$214.20/10
100264	5 Liters.....	106.58.....	191.84/2



515C Periodic Intensive Cleaner

515C is an extra strength degreaser, cleaner and grout film remover for all natural stones including polished marble, limestone, travertine, terrazzo, agglomerate and ceramic tiles.

- For periodic deep cleaning, construction clean up
- Removes grout residues & soap scum deposits
- Coverage: 100 to 600 sq. feet per liter

Stock No.	Unit	Price Ea.	Cs Price/Qty.
100243	1 Liter.....	\$21.79.....	\$196.11/10
100246	5 Liters	94.40.....	169.92/2



111M Kitchen Spray Cleaner

For all natural and engineered stone, ceramic kitchen tops, bathroom tops and wall tiles. Also works well on glass and plastic surfaces.

- Safe and easy to use
- Smells fresh and leaves no film
- Coverage: 100 to 200 sq. feet per liter, depending on surface porosity

Stock No.	Unit	Price Ea.	Cs Price/Qty.
100011.....	1/2 Liter	\$12.21.....	\$109.89/10



631C Heavy Duty Porcelain & Grout Cleaner

Heavy duty alkaline-based cleaner for porcelain and unglazed ceramic tile. 631C is also an excellent grout cleaner and can restore tile darkened by heavy soil.

- Great for food service area cleaning and construction clean up
- Removes wax coatings, oil and grease spills
- Coverage: 150 to 750 sq. feet per liter

Stock No.	Unit	Price Ea.	Cs Price/Qty.
100254	1 Quart.....	\$23.80.....	\$214.20/10
100256	5 Liters	109.44.....	196.99/2



D/2 Biological Solution Stone Cleaner

D/2 is a biodegradable, easy to use cleaning liquid that removes stains from mold, algae, mildew, lichens and air pollutants. A contact time of 10-15 minutes followed by scrubbing with a soft nylon or natural bristle brush will loosen most biological or air pollutant staining.

- For cleaning masonry, marble, granite, limestone, brownstone, travertine, terra cotta, concrete, stucco, and more

Stock No.	Description	Price
358175	D/2, Quart Pump Spray Bottle.....	\$18.95
359346	D/2, Gallon Bottle	40.95
359348	D/2, 5 Gallon Pail.....	188.25
359349	D/2, 55 Gallon Drum,.....	1,717.99

Bellinzoni



Mangia Macchia Stain Remover

Effective paste compound removes even stubborn stains like oil, grease, coffee and ketchup from natural stone surfaces.

Stock No.	Description	Price
103371	8.5 oz. container ...	\$14.50
103360	1 kg. container.....	54.00

TENAX



Tenax® Teblossom Stain Remover

Tenax Teblossom is a 2-part kit designed specifically to target stains caused by unknown reactions ("blossoms") on stone surfaces. It's unique formulation effectively draws the stains out of the stone.

Stock No.	Description	Price
200486.....	2-Part Kit.....	\$72.50



Akemi® Rust Remover

Phosphoric acid based product removes rust and prevents further rust formation on any acid resistant natural or cast stone. Follow label directions carefully when using. Akemi Rust Remover converts rust inclusions.

- Solvent-free rust inhibitor

Stock No.	Description	Price
359313.....	14 Oz. Tube.....	\$24.95



Alpha® Rust Remover

Quickly remove common rust stains from natural stone surfaces or other types of material such as concrete, brick, terra cotta, Mexican tile, or other hard porous surfaces.

- Easy to use premixed gel
- Non-hazardous chemical, safe to use and safe for the environment

Stock No.	Description	Price
116207.....	14 Oz. Tube.....	\$44.47



Pamir® Wax

Apply thin coat to marble or granite and buffed with steel wool for protection and touch-ups.

- Great for touch-ups on marble or granite
- Protects tabletops and walls
- Available in clear or black
- Liter cans

Stock No.	Unit	Color	Price
118237	Liter.....	Clear.....	\$16.99
118239	Liter.....	Black.....	16.99



Steel Wool

- Sold in packs of 16
- 1 1/2" x 1 1/2" x 4"

Stock No.	Description	Price
340295	Medium Coarse #1.....	\$4.99
698385	Medium #2.....	4.99
695448	Fine #0.....	4.99
698382	Very Fine #00.....	4.99
340292	Extra Fine #000.....	4.99
340296	Super Fine #0000.....	4.99



206R Marble Polishing Compound

206R is a unique blend of high quality polishing materials. This product restores the polish to worn Marble, Limestone, Travertine, Terrazzo and other calcium containing stone using the same process with which the original factory finish was produced.

Stock No.	Unit	Price
200006	5 lbs.....	\$54.65
200007	10 lbs.....	100.35
200008	25 lbs.....	218.75

Extra Wax™ "Green Can"

The famous "Green" can of wax. Comes in clear and black for that extra shine. As last step, rub Extra Wax on stone surface and buff with steel wool for an amazing wax shine. Wax is perfect for most stone.

Stock No.	Unit Amount	Description	Price
118212	1 Quart.....	Clear Paste.....	\$17.85
695679	1 Quart.....	Black Paste.....	17.85
695680	1 Quart.....	Liquid Clear.....	22.95



Extra Lux™ Autolucidante Auto Polish

- 75 ml. can
- Perfect for chiseled edge

Stock No.	Desc.	Price
695682	75ml.....	\$22.95



Tenax® TeWax

Use to increase the polishing effect on onyxes, marble, natural stones, granite, agglomerates, terrazzo or to brighten up a "lost" polish.

- Increase polish effect
- Safe to use
- Choose Clear or Black

Stock No.	Description	Price
691162	Clear, 1 Liter.....	\$14.95
923283	Black, 1 Liter.....	14.95



Tenax® Telux Polish

For chiseled edges and the underside of overhangs. Telux is a varnish used to create a polished effect to both smooth and raw materials such as marble & can be used on both countertops and floors.

- For indoor or outdoor application
- Safe to use
- UV stable

Stock No.	Description	Price
300497	Telux, 1 Liter.....	\$32.95



MB20 Granite Polishing Cream

MB Stone Care's MB 20 is an exclusive, proprietary blend of abrasives and polishing agents to help you achieve maximum results when polishing granite surfaces.

- Great on granite, serpentines, serpentinites and opicalcites
- Package: 4 x 2.2 lb. tubs

Stock No.	Description	Price
200020.....	4 x 2.2 lb. tubs ...	\$90.49

Akemi® Clear Paste Wax

Akemi Solid Wax is a creamy, fast drying polishing agent made of high-quality waxes for the treatment of horizontal and vertical surfaces like window sills, tiles, corners and edges. This product has a long-lasting gloss that has the ability to close fine scratches and intensify the natural color and structure of the stone.

- For both indoor and outdoor application
- Safe to use
- Long lasting

Stock No.	Unit	Price
359379	1 Liter.....	\$16.95



Akemi® Spider Enhancer

Akemi Spider Black and Spider Clear Enhancers hide "spider veins" (micro fissures) on natural stone surfaces in just minutes. These two products also enrich the gloss of the entire surface of natural stone.

- For indoor applications
- Safe to use
- Solvent-based

Stock No.	Description	Price
359428	1 Liter, Spider Black.....	\$35.95
3594278	1 Liter, Spider Clear.....	35.95



Surface Pro® Marble Honing Powders

Specially formulated for light duty restoration of Marble, Limestone, Travertine, Terrazzo and other calcium containing stone surfaces. Surface Pro™ Honing Powders are quick and easy to use & non-acidic.



180 Grit Honing Powder

For restoring heavy traffic areas, removing etch marks, and small restoration jobs without the need of lippage removal. Follow with 320G Surface Pro® Powder.

Stock No.	Description	Price/Ea.
104185	10 lbs	\$74.40
104190	25 lbs	155.90
104180	50 lbs	273.99



320 Grit Honing Powder

For restoring medium traffic lanes, removing etch marks, and small restoration jobs without the need of lippage removal. Follow with 600G Surface Pro® Powder.

Stock No.	Description	Price/Ea.
104325	10 lbs	\$90.00
104330	25 lbs	188.10
104320	50 lbs	316.70



600 Grit Honing Powder

For restoring fine traffic lanes, removing light etch marks, and steel wool scratches without the need of lippage removal.

Stock No.	Description	Price/Ea.
104603	10 lbs	\$111.95
104606	25 lbs	259.15
104600	50 lbs	436.60



Tenax® Polishing Powder

Tenax polishing powders are formulated specifically to create a high gloss finish on stone. Tenax polishing powder may be used on countertops, floors, and as a general maintenance product. Simple and easy to use. Tenax Granite polishing powder is designed for granite to bring out a higher gloss finish on all types of granite.

- Available for Granite or Marble

Stock No.	Description / Unit	Price
923275	Marble Polish, 2 Lb. Tub	\$22.99
923277	Granite Polish, 2 Lb. Tub	22.99



119M Marble and Granite Gloss

119M Marble and Granite Gloss is a silicone wax based polish that cleans, protects and conditions any polished stone or ceramic surface. Ideal for maintaining polished natural stone bar tops, furniture, shower stalls and fireplaces as well as polished metals like brass, bronze and aluminum, 119M is safe and easy to use in homes or commercial cleaning operations.

Stock No.	Unit	Price Ea.	Case Price/Qty.
100029	1 Liter	\$21.05	\$189.45/10

106R Granite Polishing Paste

106R Granite Polishing Paste is a creamy paste that contains high quality polishing abrasives for granite polishing and re-polishing. Use 106R as the final polishing step after diamond honing for a brilliant factory type polish, or for polish maintenance on a regular basis in commercial areas.



Stock No.	Unit	Price Ea.
100018	1 Kilogram	\$78.50

205X Marble Polishing Powder

205X Marble Polishing Powder is a blend of high quality Italian polishing materials. The solid form of this powder is the most popular polishing media used in Italian Marble Factories. Commonly referred to as "5X Powder".



Stock No.	Unit	Price/Ea.
100052	2 kg	\$37.95
100053	10 kg	156.95
100054	20 kg	257.95



SCS-GIALOTEX
Polishing Powder for Colored Marble and Terrazzo

Uniquely formulated to produce the maximum color and polish, SCS-Gialotex Polishing Powder for Colored Marble and Terrazzo is an excellent final polishing step after honing. Also use for maintenance re-polishing. 2 kilogram (4.4 lb.) buckets.

Stock No.	Price/ea.	Case Price/Qty.
115536	\$44.95	\$323.64/8 Buckets



SCS-Velotex Polishing Powder for white marble and terrazzo. Great results on all white marble and especially on types of marble with a high amount of crystal and those with low calcium content.
• 2 kilogram (4.4 lb.) bucket

SCS-VELOTEX

Polishing Powder for White Marble and Terrazzo

Stock No.	Price/ea.	Case Price/Qty.
115540	\$44.95	\$323.64/8 Buckets



SCS-Potea Blanca is formulated using a special blend of metal oxides for use as the final abrasive polishing step after honing medium to light colored granite.
• 2 kilogram (4.4 lb.) bucket

SCS-POTEABLANCA

Polishing Powder for Medium to Light Colored Granite

Stock No.	Price/ea.	Case Price/Qty.
115527	\$52.95	\$381.24/8 Buckets



SCS-Greentex is formulated using a high amount of metal oxides and is effective as a final polishing step after honing green marble and terrazzo or as a polishing powder for green marble and terrazzo. Great for maintenance re-polishing in high traffic areas.
• 2 kilogram (4.4 lb.) bucket

SCS-GREENTEX

Polishing Powder for Green Marble and Terrazzo

Stock No.	Price/ea.	Case Price/Qty.
115537	\$38.95	\$280.44/8 Buckets



SCS-Potea Gris is a proprietary blend of metal oxides, formulated for use as the final abrasive polishing step after honing black and very dark granite.
• 2 kilogram (4.4 lb.) bucket

SCS-POTEAGRIS

Polishing Powder for Black & Dark Colored Granite

Stock No.	Price/ea.	Case Price/Qty.
115538	\$52.95	\$381.24/8 Buckets

Dia-Glo™
Buffing Compounds

Formulated to yield excellent buffing results on all stone surfaces. Available in four types: **M** for marble surfaces, terrazzo and agglomerated marble; **D** to enhance the rich colors and gloss in medium to dark stones; **L** for use on light colored granite; and **S** for restoring black granite to its original gloss and deep color.

Stock No.	Type	Unit	Price
900374	M (Marble) Powder	1 Quart (1.7Lbs, Net Wt.)	\$41.00
900373	M (Marble) Powder	2 Gallons (18.8 Lbs, Net Wt.)	\$22.28
900378	D (Dark Granite) Powder	1 Quart (1.7Lbs, Net Wt.)	\$36.90
900372	D (Dark Granite) Powder	2 Gallons (18.8 Lbs, Net Wt.)	\$302.38
900376	L (Light Granite) Powder	1 Quart (1.7Lbs, Net Wt.)	\$36.90
900371	L (Light Granite) Powder	2 Gallons (18.8 Lbs, Net Wt.)	\$302.38
900375	S (Black Granite) Powder #1	1 Pint (14 Oz, Net Wt.)	\$54.33
900377	S (Black Granite) Liquid #2	1 Quart	\$54.33
900381	S (Black Granite) Liquid #2	5 Quarts	\$194.75





Reulin Polishing Powders

For high-gloss polishing of marble and granite using a felt polishing buffer.

- 2 kg plastic bucket
- Tin oxide-based polishing powder for granite
- Oxalic acid-based polishing powder for marble

Stock No.	Description	Unit	Price
104730	M White (Marble).....	2 kg.....	\$13.95
104712	H White (Granite).....	2 kg.....	14.95
104714	H Red (Granite).....	2 kg.....	57.90
104724	H Black.....	2 kg.....	50.00

(Granite, dark hard stone)

SCS-CR-2 Heavy Duty Crystallizer for Marble and Terrazzo

For use on marble and terrazzo surfaces to create a liquid-proof and slip-resistant gloss after honing or in intense traffic areas for maintenance.



Stock No.	Unit	Price Ea.	Cs Price/Qty.
115531.....	5 liter.....	\$52.95.....	\$190.62/4

SCS-CR-3 Maintenance Crystallizer for Marble Terrazzo

Designed for quick polish maintenance of marble and terrazzo surfaces. Spanish Maintenance Crystallizer for Marble and Terrazzo is specifically recommended for use on white marble and is suitable for daily use on all marble and terrazzo.



Stock No.	Unit	Price Ea.	Cs Price/Qty.
115532.....	5 liter.....	\$52.95.....	\$190.62/4

SCS-CR-5 Polishing Fluid for Black and Very Dark Granite

A very special, one of a kind, polishing fluid for use as the final step in the restoration of black and very dark colored granite. Use Black and Very Dark Granite Polishing Fluid after honing and powder polishing to "POP" the final polish and restore the rich dark color.



Stock No.	Unit	Price Ea.	Cs Price/Qty.
115533.....	5 liter.....	\$114.05.....	\$410.58/4

SCS-CR-6 Polishing Fluid for Light Granite

A special, one of a kind, polishing fluid for use as the final step in restoration of medium to light colored granite. Use Light Granite Polishing Fluid after honing and powder polishing to "POP" the final polish and restore the full color.



Stock No.	Unit	Price Ea.	Cs Price/Qty.
115534.....	5 liter.....	\$114.05.....	\$410.58/4



Italian Craftsman Marble Polish

A non-wax polish for marble. Clean, polish and protect your counter tops, table tops and wall panels.

- Not recommended for floors

Stock No.	Description	Price
117295	16oz.....	\$9.20
117297	1 gal.....	70.49

10" Cocoa Mat Buffers

Abrasive cocoa buffers for use with automatic top polishing equipment, applies enough pressure to bring out a consistent polish.

- Available in rolled and rubber backed mat cocoa fibers



Stock No.	Description	Price
363795	10" Cocoa Buffer.....	\$79.95

Compressed Felt Buffing Pads

- For use with polishing bars and powders

Stock No.	Dia.	Description	Price
116810	5".....	5/8"-11 F.....	\$76.60
116813	7".....	5/8"-11 F.....	115.95
115884	4".....	Fits Tornado I.....	42.95
116285	3".....	Q.R.S. backing.....	12.89
116283	4".....	Q.R.S. backing.....	16.05
116282	5".....	Q.R.S. backing.....	21.45
696103	6".....	80 Ply.....	18.89
696111	8".....	80 Ply.....	21.95



Diarex® Polishing Bars

Paste bars are melted into a buffer for high-gloss polishing of marble or granite.



Stock No.	Description	Price
696479	Marble Polishing Bar (White).....	\$10.52
696523	Granite Polishing Bar (Black).....	10.29

CLAMPS



MitreForma® Clamps

Precision design for perfect mitre joints

Stock No.	Description	Price
310150	Small (Up to 130mm)	\$203.95
310151	Large (120- 320mm)	234.95
021076	Glue-Catch, 40 Ct.	10.83



GranQuartz® 90° Miter Clamp

- Maximum opening capacity: 12"
- Normal load limit: 600 lbs.

Stock No.	Description	Price
340290	Set of 2 w/Bag.....	\$308.15



Irwin® Quick-Grip® C-Clamps

Stock No.	Throat Depth	Price
053612	4 1/2"	\$9.35
053601	2 7/8"	7.99
053604	3 1/2"	10.39
053610	4"	15.99

Economy C-Clamps

Stock No.	Frame Opening x Depth	Normal Load Limit	Price
693897	4"	1100 lbs.....	\$5.69

Irwin® 12" Bar Clamp

Handle is larger and more ergonomic, allowing high clamping pressure with less effort

- I-beam bar reduces flexing and bowing
- Larger clutch plates allow for easier release and increase durability and dependability
- Throat opening: 2.5" (#053602) or 3" (#053605)



Stock No.	Description	Price
053602	600 Lb. Load Limit	\$12.49
053605	1,000 Lb. Load Limit	15.15

Irwin® Quick-Grip® SL300 One Handed Bar Clamp

- Locking swivel jaws with removable full-face pads for even distribution of force
- Removable pads protect work surface
- 300 lb. Clamping force
- Easy one-hand clamping
- Quick-Change™ screw easily converts clamp to a spreader, eliminates rattle in end-jaw



Stock No.	Desc.	Normal Load Limit	Price
053608	12"	300 lbs	\$24.87
053613	18"	300 lbs	24.95



Irwin® Resin Spring Clamp

- Throat depth: 2"

Stock No.	Price
053609	\$6.75



Irwin® Metal Spring Clamps

Stock No.	Max. Opening Between Jaw	Price
053603	2"	\$2.99
053606	3"	7.95

Miter-It™ Clamps

The Miter-It™ clamp is an easy-to-use jig that allows finished-side-up miter laminations. Not flipping the material offers numerous benefits: increased safety for workers, reduced risk of damage to the material, and keeping the seam in view during lamination. The Miter-It securely holds edges at 90°, eliminating the need for a helper to position the material. The clamp's weight and non-marking, non-skid contact surface hold the product and miter piece in place.

- More efficient than taping methods alone
- Highly durable steel construction with powder-coat finish
- Accommodates laminated edges from 1.5" - 6"

Stock No.	Description	Qty	Price
340314	Miter-It Original	1	\$195.00
350307	Miter-It Corner	1	395.00

PATENT US9393765

Made in the USA from US & imported parts.



#340314



#350307



Don't flip it, Miter-It finished side up!



WATERPROOF BOOTS, CLOTHING, SLEEVES & APRONS

Premium Over-The-Shoe Boots



Premium waterproof over-the-shoe boots with slip resistant tread for traction on wet surfaces.

- Available in sizes 9-16
- Strap adjustment for secure fit

Stock No.	Size	Price	Stock No.	Size	Price
350021	9	\$37.00	350025	13	\$37.00
350022	10	\$37.00	350026	14	\$37.00
350023	11	\$37.00	350027	15	\$37.00
350024	12	\$37.00	350028	16	\$37.00

Over-The-Shoe Pull on Boots

- Slip-resistant outsole for traction on wet surfaces
- Top strap and buckle adjustment for secure fit

Stock No.	Size	Price	Stock No.	Size	Price
350001	9	\$22.95	350005	13	\$22.95
350002	10	\$22.95	350006	14	\$22.95
350003	11	\$22.95	350007	15	\$22.95
350004	12	\$22.95	350008	16	\$22.95



Steel Toe Chesapeake PVC Work Boots

- Abrasion-resistant nylon net lining for easy on/off
- V-bar molded shank for complete outsole support

Stock No.	Size	Price	Stock No.	Size	Price
867767	7	\$22.19	867711	11	\$22.19
867768	8	\$22.19	867712	12	\$22.19
867769	9	\$22.19	867713	13	\$22.19
867710	10	\$22.19	867714	14	\$22.19



DuraPro® Steel Toe Work Boots

Onguard DuraPro® boots are a revolution in safety and comfort. Made in the USA.

- Superior shock absorption, support and comfort
- Slip-resistant outsole for increased traction in any conditions
- Sloped comfort top rim prevents chafing, reduces discomfort



Stock No.	Size	Price	Stock No.	Size	Price
340231	8	\$45.00	340390	12	\$45.00
340232	9	\$45.00	340391	13	\$45.00
340388	10	\$45.00	340392	14	\$45.00
340389	11	\$45.00			

Borg Liner For PVC Boots

Fits all PVC Boots to provide additional warmth and comfort. Allow for 1 size larger boot when using a liner.



Stock No.	Size	Price
340227	Medium (8-9)	\$14.00
340228	Large (10-11)	\$14.00
340229	Xtra-Large (12-13)	\$14.00

Premium Water Proof Protective Wear

Premium waterproof pants and jackets are made using heavy duty .65mm ribbed PVC on non-woven polyester. Available in sizes Large to XXXL, and for our customers who like a longer jacket, a NEW 48" length version (with hood snaps and detachable hood) is now available.

- Heavy Duty ribbed PVC on non-woven polyester (.65mm thick)
- Reinforced inseam to prevent splitting
- Heavy Duty adjustable suspenders
- Adjustable waist snaps for the perfect fit
- Ankle and cuff take-up for a snug/tapered fit
- Jacket with storm flap front and two front snap pockets
- Underarm vents to keep you cool

Stock No.	Description	Size	Price
350037	HD Rain Jacket, Hood	L	\$27.75
350038	HD Rain Jacket, Hood	XL	\$27.75
350039	HD Rain Jacket, Hood	XXL	\$27.75
350040	HD Rain Jacket, Hood	XXXL	\$27.75
760420*	48" L Rain Jacket, Hood Snaps	L	\$29.15
760421*	48" L Rain Jacket, Hood Snaps	XL	\$29.45
760422*	48" L Rain Jacket, Hood Snaps	2XL	\$29.45
350041	HD Bib Overall	L	\$27.75
350042	HD Bib Overall	XL	\$27.75
350043	HD Bib Overall	XXL	\$27.75
350044	HD Bib Overall	XXXL	\$27.75

Heavy Duty .65mm Ribbed PVC Construction



*Does Not Include Hood

49" Raincoat with Detachable Hood

Yellow 49" raincoat with front snap closure features 0.35 mm PVC construction on polyester broadloom fabric. Comes with welded seams includes raglan sleeves, under-arm air vents and attached drawstring hood. Raincoat has cape ventilated back with 3 mesh holes and rounded collar. With black plastic take up snaps at the wrist and black plastic snap storm fly front.

- Detachable drawstring hood
- Black plastic take up snaps at waist and ankle
- 2 Patch pockets w/ flap of same material
- Welded 3" above the hem



Stock No.	Description	Price
697301	XL, 49" Length	\$20.99
697302	2XL, 49" Length	\$20.99

Waterproof Jacket

- Under-arm vents to help keep you cool
- Attached hood
- High quality PVC on polyester
- Storm flap front w/two front snap pockets

Stock No.	Size	Price
350015	L	\$13.85
350016	XL	\$13.85
350017	2XL	\$13.85



Dust and Silica Warning See Inside Front Cover

California residents see Prop 65 warnings www.P65Warnings.ca.gov

Neoprene Waterproof Apron

Durable and comfortable apron with "stressless" neck straps, economic and suitable for most wet fabrication use.

- 12.5 Oz. Neoprene construction
- Strain-free neck strap design for comfort

Stock No.	Description	Price
364535	Standard Apron.....	\$14.95



18 oz. Hycar Apron

Same design as our Neoprene apron but constructed of heavy-duty 18 oz. Hycar.

- Strain-free neck strap design for comfort

Stock No.	Description	Price
364536	Heavy-Duty Apron.....	\$19.95

Fabricator's Friend™ Bullet Proof™ Aprons

Lighter, more durable, very comfortable and safer than any other apron on the market.

- Heavy duty ultra-tough & waterproof poly coated Cordura fabric
- Made in America
- Neoprene neck strap

Stock No.	Description	Price
695417	Standard Apron.....	\$65.99
600549	Deluxe Apron.....	\$85.00



Pro Series® Heavy Duty Apron and Water Proof Sleeves

Made of high-quality nylon w/Velcro® strips on the front to hold polishing pads. Waterproof pockets protect your valuables and accessories.

- 35 3/8" (90 CM) W x 47 1/4" (120 CM) H
- Strong clip with adjustable strap fits all sizes
- Front utility strips on apron hold polishing pads for fast pad changes

Stock No.	Description	Price
340165	Sleeve Protectors (pair).....	\$22.50
340166	Apron.....	25.02



GranQuartz® Economy Waterproof Apron

- Vinyl construction
- 35" x 45", safety yellow

Stock No.	Price
340010.....	\$12.70



Diarex® Vinyl Stone Cutters Aprons

- Rugged construction
- Neck loop & waist tie straps
- 36 x 44"

Stock No.	Description	Price
108613	White PVC.....	\$27.70
696158	Black 26 Oz. Vinyl.....	25.15
696476	White 26 Oz. Vinyl.....	25.15



Diarex® Gray Rubber Aprons

- Heavy duty, fabric reinforced rubber material
- Made in Germany
- Durable in even the harshest shop conditions

Stock No.	Size	Price
108611	35 1/2 x 44".....	\$77.99
108612	44 x 48".....	89.99



Alpha® Water Proof Fabrication Aprons

Alpha's new shop apron is made with D900 Oxford/PU coated material which is commonly used for waterproof safety jackets for outdoors. Compared with other materials used for aprons, this is much lighter weight and has a very good waterproofing capability.

- Memory-function waist band eliminates the need for a neck strap to improve comfort
- Protects from dust, water, chemicals and polishing slurry
- Available in long sleeve or sleeveless style

Stock No.	Description	Price
340315	Apron, Sleeveless.....	\$27.72
340304	Apron, Long Sleeves.....	45.94



Diarex® Vinyl Sleeve Protectors

- Sold in pairs, nylon reinforced
- Elastic at top and bottom

Stock No.	Price/Pair
340158.....	\$8.10



Fabricators Friend™ Stone Sleeves™

Experience the solution to wet polishing and working around natural stone with waterfed tools. Stone Sleeves allow fabricators to stay dry and warm in wet conditions.

- Soft, comfortable wrist seal
- Water proof, poly coated Cordura
- Manufactured to the same specs as military dive suits

Stock No.	Item	Price
697308	Stone Sleeves.....	\$55.00



OCCUPATIONAL SAFETY SUPPLIES



Tenacious Work Gear® Elastic Back Support

Heavy-duty woven elastic back and rubber coated, sewn-in support stays offer superior abdominal support.

Stock No.	Size	Price
711092	Small, 25"-30"	\$20.88
711093	Med., 30"-34"	20.88
711094	Large, 34"-38"	20.88
711095	XL, 38"-42"	20.88
711096	2XL, 42"-46"	20.88
711097	3XL, 46"-52"	20.88
711098	4XL, 52"-58"	20.88



LIFT® Fiberware Cut 5 Sleeve



Fiberware™ cut 5 sleeve covers your entire arm with cut level 5 protection. The thumb loops keeps the sleeve in place, while the unique contour palm cut eliminates material bunching while wearing a glove.

- Adjustable bicep closure ensures a good fit on most users
- One size fits all

Stock No.	Description	Price
103733	Pair, One Size.....	\$17.31

LIFT® Factor Knee Guard



Hardshell kneepad featuring PU foam padding for protection and comfort. The ballistic nylon construction resists abrasion for increased durability. Sizes: One size fits all

- Fully adjustable two straps system reduces binding and slipping
- Quick-release buckle fasteners allow for easy application and removal

Stock No.	Size	Price
103740	One Size Fits All	\$20.99



LIFT® Apex Gel Knee Guard



Innovative internal gel insert molds and forms to the patella and knee cap. Provides non marring, maximizing stabilization and protection. Hinged upper support strap is removable and prevents binding while the TPR cap maximizes tracking and stability on all surfaces. One size fits all.

- Fully adjustable two straps design resists slipping
- Designed to prevent "roll-off" on hard surfaces
- Fully adjustable two straps system reduces binding and slipping

Stock No.	Size	Price
103741	One Size Fits All	\$52.49



LIFT® Protective Shoe Covers

- Latex free
- Fluid Repellant
- Breathable 40g spunbond material
- Anti-skid bottom
- One size fits most

Stock No.	Qty.	Price
103752	100 Ct. Box	\$19.94

LIFT® Cooling Head Gear

LIFT Cooling Gear is designed to keep your core temperature regulated hot environments so you can work more efficiently.

- Lightweight multi-fiber polymer embedded fabric.
- Once saturated with water, the material allows it to slowly evaporate, extracting warmth and delivering cool air to your body.
- Sizes: One size fits all

Stock No.	Size	Price
103746	Cooling Beanie, Blue	\$12.06
103747	Cooling Beanie, Black	12.06
103748	Cooling Beanie, Flag Pattern	12.06
103749	Cooling Beanie, Realtree	13.64
103750	Sweat Beanie, Black	7.34
103751	Sweat Beanie, Flag Pattern	7.34
103743	Cooling Skull Cap, Black	13.64
103744	Cooling Skull Cap, Flag Pattern	13.64
103745	Cooling Skull Cap, Realtree	13.64



Cooling Skull Cap



Cooling Beanie



Particulate Respirator

- NIOSH approved, N95
 - Adjustable nose piece w/foam cushion
 - 20 masks per box
- 340017..... **\$15.59**



Moldex® 2200N95 Disposable Respirator

Softspun® lining gives added comfort and durability.

- Dura-Mesh™ shell protects filter.
 - 20 per box.
- 340025..... **\$29.51**

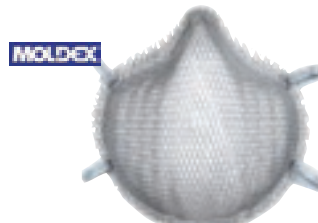

Moldex® 1200N95 Dirt Dawg® Dust Mask

- Specially designed for stone dust
 - N95 Rating
 - 20 per box
- 340013..... **\$28.00**

**Moldex®
2300N95
Disposable Respirator**

Exhale valve reduces hot air build-up, keeping workers cooler and more comfortable.

- 100% PVC-Free
- Ventex™ exhale valve
- N95
- 10 per box.

Stock No.	Description	Price/Box
100070	Moldex 2300N95.....	\$33.65



Moldex® 2700N Dust Masks

- Handy Strap™ with buckle for quick release of mask
- Ventex® valve lets hot air out faster so workers breath easier and stay cooler
- N95
- 10 per box.

Stock No.	Description	Price/Box
340024	Moldex2700N	\$47.69



3M™ Particulate Respirator 8210

- Welded strap attachment
- Cushioning nose foam
- Adjustable nose clip helps provide a custom fit and secure seal

Stock No.	Description	Price/Box
696109	3M 8210.....	\$20.40



**Moldex®
7000/7800 Series Respirators**

7000 and 7800 Series respirators are lightweight with an extra-wide sealing area for all day comfort and safety. Mask drops down for storage around neck while not in use, or locks down for a custom fit.

Stock No.	Description	Price
794100	Model 7000 w/P100 Filters, SMALL.....	\$30.38
794200	Moldex 7000 w/P100 Filters, MED.....	30.38
794300	Moldex 7000 w/P100 Filters, LARGE.....	30.38
794000*	Moldex P100 Filters (Pair).....	11.68
007801	Moldex 7800 Premium Mask, SMALL	39.51
007802	Moldex 7800 Premium Mask, MED.....	39.51
007803	Moldex 7800 Premium Mask, LARGE.....	39.51
792000	Moldex Piggyback Adaptor	6.63
710000	Moldex Organic Vapor Cartridges (2).....	16.72

*#794000 P100 Filters can be used w/ Series 7000, 7800 & 9000 respirators



Silica Danger Shop Sign

Make sure hazardous areas of your workplace are clearly designated with this silica warning sign.

- 10" x 14" reusable plastic sign
- Includes 4 holes for mounting but no screws

Stock No.	Description	Price
102320	"Danger" Sign	\$12.99

**Moldex® 9000 Series
Full Face Respirators**

Moldex 9000 full face respirators feature an exclusive over-molded lens design eliminating a heavy clamping frame for a full face with lighter weight, greater field of vision, fewer parts, minimal maintenance and completely free of metal parts.

- Ultra-lightweight comfort
- Strap buckles are securely molded to facepiece
- Coated lens is scratch resistant

Stock No.	Description	Price
009002	9000 Facepiece Only, MED.	\$166.07
794000	Moldex P100 Filters (Pair).....	11.68



**Moldex® Bitrex
Qualitative Fit Test Kit**

Fit your respirator for a tight seal to ensure safety against hazards in the workplace with the Bitrex Qualitative Fit Test Kit.

- Kit includes: (2) Nebulisers, test hood, (6) 2.5ml ampules Bitrex™ Sensitivity Solution, (6) 2.5ml Ampules Bitrex™ Test Solution, (2) spare parts for nebulisers & Moldex Qualitative Fit Test CD

Stock No.	Description	Price
010200	Bitrex Qualitative Fit Test Kit.....	\$346.33
050400	Bitrex Fit Test Solution 2.5ML.....	21.47



**LIFT® Strobe
Safety Glasses**

Lightweight, low profile safety glass with a nylon frame and polycarbonate lenses. Small to medium fit and coverage. Frame constructed with soft rubber temple and nose bridge.

Stock No.	Description	Price/ea.
103713	Silver/Clear.....	\$8.39
103714	Silver/Smoke.....	8.39
103715	Camo/Clear.....	9.44
103716	Camo/Smoke.....	9.44
103717	Camo/Amber.....	9.44



**LIFT® Sectorlite
Safety Glasses**

Extremely lightweight polycarbonate frameless protective eye-wear. Soft rubber temple tail inserts and nose bridge.

Stock No.	Description	Price/ea.
103709	Clear.....	\$7.34
103710	Smoke.....	7.34
103711	Yellow.....	7.34
103712	Mirror.....	7.34



**LIFT® Quest
Safety Glasses**

Sport styled, partial frame protective eye-wear offering lightweight, low profile option. Small to medium fit and coverage. Frame constructed with soft rubber temple and nose bridge.

Stock No.	Description	Price/ea.
103718	Camo/Clear.....	\$8.39
103719	Camo/Smoke.....	8.39
103720	Camo/Amber.....	8.39



Ever-Lite® Safety Glasses

- Scratch-resistant, Polycarbonate lens provides 99.9% UV protection
- Soft nosepiece for snug fit
- Exceeds ANSI Z87.1 high impact requirements

Stock No.	Description	Price
340350	Clear Lens.....	\$4.99
340351	Amber Lens.....	5.49



Integra® Safety Glasses

- 99% UV protection
- Clear polycarbonate lens
- Anti-scratch coating

Stock No.	Description	Price
340030	Clear Lens.....	\$2.99



Azera® Safety Glasses

- 100% UVA & UVB protection
- Straight back flexible temples for a great fit
- Rubber flange nose piece for all day comfort
- Clear polycarbonate scratch-resistant lens
- Exceeds ANSI Z87.1 high impact requirements
- Protection from excessive glare

Stock No.	Description	Price
340386	Clear Lens.....	\$6.99
340387	Amber Lens.....	7.25



Furix® Safety Glasses

- Provides 99.9% UV protection
- Lightweight contemporary frame
- Wrap around style • Anti-fog lens

Stock No.	Description	Price
000754	Black Frame.....	\$9.99



PM Extreme® Safety Glasses

- Rubber temple tips & rubber nose piece for secure fit
- Provides 99.9% UV protection
- Scratch resistant, includes black lanyard

Stock No.	Description	Price
000750	Black Frame, Clear Lens.....	\$6.99
000751	Black Frame, Amber Lens.....	6.99



Accurist® Safety Glasses

- Inner foam padding & rubber nose piece for secure fit
- Provides 99.9% UV protection
- Scratch resistant anti-fog clear lens

Stock No.	Description	Price
000753	Black Frame, Clear Lens.....	\$10.99

Moldex® Z2 Standard Earmuffs

- NRR25 Rating

340038.....Standard.....\$16.23



Moldex® M1 Premium Earmuffs

- NRR29 Rating

340039.....Premium.....\$38.63



Moldex® Softies® Earplugs

- 200 pairs per box
- Soft, disposable foam earplugs
- 100% PVC-Free®
- Highest independently tested NRR 33
- Tapered for easy insertion
- Longer length for easy fit & comfort

696365.....\$40.38



Moldex® Pura Fit® Earplugs

- 200 pairs per box
- Soft, disposable foam earplugs
- 100% PVC-Free®
- Highest independently tested NRR 33
- Tapered and longer length for easy fitting and removal in any size ear canal

340020.....\$39.69



Moldex Spark Plugs® Earplug Station

- Convenient wall-mount dispenser.
- Just twist dial for new set
- High NRR 33 rating suitable for most noisy environments
- 250 brightly colored pairs per container (#340021/Spark Plugs Station)

Stock No.	Description	Price
340021	Spark Plugs Station.....	\$45.61
340019	100 pairs w/cord.....	35.40



Dust and Silica Warning See Inside Front Cover



California residents see Prop 65 warnings www.P65Warnings.ca.gov

SHOP SUPPLIES



Glasochrome Pencils

Water soluble, high quality oil chalks for marking wet surfaces. Difficult to remove.

Stock No.	Color	Price Per Box
105179	Yellow, Box of 12.....	\$20.75
105180	Red, Box of 12.....	20.75
105181	White, Box of 12	20.75



Omnichrome Pencils

Water soluble; easy to remove oil pencils.

Stock No.	Color	Price Per Box
105189	Yellow, Box of 12.....	\$20.75
105190	Red, Box of 12.....	20.75
105191	White, Box of 12	20.75



**GranQuartz®
25' Tape Measure**

- Durable ABS case
- Triple riveted end hook
- High carbon steel blade

Stock No.	Price
340204	\$8.59



**Komelon®
Speed Mark
16' Tape Measure**

- Fractional marks on tape make it easy to read
- Matte finish tape

Stock No.	Price
541600	\$7.50

**Permanent
Paint Markers**

- Quick drying
- 6 Per box
- Water resistant
- Smooth marking



Stock No.	Type/Color	Price
105183	Metal tip/White.....	\$3.49
105187	Metal tip/Yellow.....	3.49
693885	Metal tip/Red.....	3.49
105184	Fiber tip/White.....	3.49
105185	Fiber tip/Black.....	3.49
105186	Fiber tip/Red.....	3.49
105188	Metal tip/Orange.....	3.49



China Markers

Waterproof and perfect for marking on most smooth surfaces.

- Sold in boxes of 12
- Easy peel off wrapper
- Needs no sharpening

Stock No.	Color	Price
340171	Red	\$8.29
340172	Yellow	8.29
340173	White	8.29
340174	Black	8.29



**GranQuartz®
Utility/Tool Bag**

- 17" Long, 10" Wide, 11" High
- Large main opening and multiple side pockets.

Stock No.	Price
340289	\$28.25



**GranQuartz®
Stainless Steel Tape Measures**

- Durable rubberized case for easy grip
- Matte finish stainless steel tape resists rust

Stock No.	Length	Price
340215	16'.....	\$15.05
340216	25'.....	20.49



Grout Sponges

- Hydrophilic grout type
- 5" x 7 1/2" x 2" width

Stock No.	Price
340121	\$2.25 ea.



#104958

**Pneumatic Tool
Accessories**

Stock No.	Description	Price
104950	Coilhose 3/8" FPT Connector	\$3.25
104951	Coilhose 1/4" MPT Connector	2.95
104952	Coilhose 3/8" MPT Connector	2.99
104953	Coilhose 3/8" FPT Coupler.....	13.99
104954	3/8" Male NPS x 1/4" MPT Adapter.....	3.99
104955	3/8" Regulator w/Gauge.....	69.50
600670	Tool Lubricant.....	9.49



#104953



#104954



#104953



#104950



#104951



#104952



#600740

#600741



#600742

**Coilhose Blow Guns
(Nozzles)**

Standard, High Volume and In-Line Blow Guns from Coilhose. Tough zinc die cast bodies are made to last in even the harshest environments.

- Available in standard or in-line models
- Conform to OSHA standards

Stock No.	Description	Price
600740	Standard 600-S	\$11.99
600741	High Volume 600V-S	18.40
600742	In-Line w/Metal Tip.....	12.15



Empire® True Blue 6" Combination Square/Level

- For measuring and marking 45° and 90° angles.
- High impact acrylic e-Band mono vial
- Etched markings
- Heavy duty machined head for precision
- Scriber pin stored on board for convenient marking of materials

Stock No.	Description	Price
003208	16" x 24" Combination Square.....	\$15.99



Empire® E-250 Combination Square

- For measuring and marking 45° and 90° angles.
- 12" steel blade with inch graduations
- Machined square head, "True Blue" level vials
- Self-aligning drawbolt

Stock No.	Description	Price
003210	12" Square Combo	\$16.99



Empire® E50 Aluminum Levels

- "True Blue" vials are accurate to within 0.0005" per inch in all working positions.
- New ergonomic handgrips that provide a comfortable grip & cover the internal openings in the extrusion.
- High visibility plumb vial surrounds make viewing easier in all light conditions.
- Durable center vial surround aids visibility and protects the vials.

Stock No.	Description	Price
003201	24" Level.....	\$20.75
003202	48" Level.....	29.35
003207	96" Level.....	102.25



Empire® 1140 Aluminum Framing Square

- 24" x 2" body, 16" x 1-1/2" tongue, 1/8" thick
- Aluminum construction will not rust or corrode

Stock No.	Description	Price
003203	16" x 24" Square.....	\$11.79



Empire® Aluminum Straight Edge

- Easy reading inch scale graduations
- Aluminum construction will not rust or corrode

Stock No.	Description	Price
003205	72" L x 2" W.....	\$19.95



Empire® E902 All Purpose Cutting Guide

- 2 Heavy-duty aluminum rails joined together make straight, accurate cuts up to 8' 6"
- Includes both rails, joiner plate, 2 C-clamps
- Use with circular saw, router, utility knife or jigsaw

Stock No.	Description	Price
003204	Cutting Guide.....	\$32.25



Pro Series® Legend Single Edge Razor Blades

Stock No.	Description	Price
340122	100 Per Box.....	\$5.19



Pro Series® Single Edge Razor Blades

Stock No.	Description	Price
340066	100 Per Box.....	\$4.36



Retractable Utility Knife

Great forevery day use

Stock No.	Price
340205	\$3.40

Replacement Blades

100 utility knife blades in plastic dispenser.

Stock No.	Price
340206	\$12.25



The Shave It™ Filler & Seam Cleaner

Shave It scraper uses 12 razor blades to scrape away excess adhesive on seams. Blades are easily replaced by removing 2 screws. Uses Standard single edged razor blades.

Stock No.	Description	Price
101715	Shave It Scraper.....	\$19.95

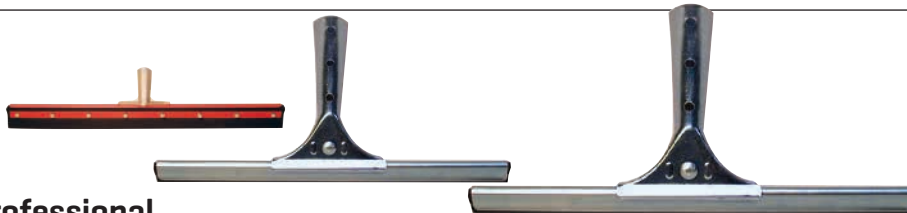

Professional Grade Squeegees

Efficient water removal on most surfaces.

Hand held

- Top quality natural rubber blade
- Easy to hold, fits tapered handles

Floor model

- Heavy duty, available in straight or curved style
- Dual foam rubber strips

Stock No.	Description	Price
340142	12" Premium Hand Held.....	\$11.49
340167	18" Hand Held Premium Squeegee.....	13.55
340143	24" Floor Model Straight.....	23.99
340144	24" Floor Model Curved.....	26.35
340145	36" Heavy Duty Floor-Doublesided.....	39.60
340147	12" Replacement Rubber Blade, Hand Held.....	3.25
340179	18" Replacement Rubber Blade, Hand Held.....	5.45
340149	24" Replacement Rubber Blade, Floor Model.....	8.85
341136	36" Replacement Rubber Blade, Floor Model.....	12.85

VARIABLE SPEED ANGLE GRINDERS



TOOL SCHEMATICS AVAILABLE: GranQuartz.com



5" Makita® GA5042C SJS II Angle Grinder

- 12 AMP motor
- 2,800-11,000 RPM electronic variable speed
- Electronic speed control maintains desired speed under load
- Super Joint System helps prevent kickback & protects gears

115248..... **\$189.99**
 Replacement Carbon Brushes (set)
 116404..... **\$12.95**

4 1/2" Makita® GA4542C SJS II Angle Grinder

- 12 AMP motor
- 2,800-11,000 RPM electronic variable speed
- Electronic speed control maintains desired speed under load
- Super Joint System helps prevent kickback & protects gears

115247..... **\$169.99**
 Replacement Carbon Brushes (set)
 116404..... **\$12.95**



4 1/2" Makita® 9564CV SJS Angle Grinder

- 12 AMP motor
- 2,800-10,500 RPM electronic variable speed
- Electronic speed control maintains desired speed under load
- Super Joint System helps prevent kickback while protecting gears

116405..... **\$175.00**
 Replacement Carbon Brushes (set)
 116404..... **\$12.95**



5" Makita® 9565CV SJS Angle Grinder

- 12 AMP motor
- 2,800-10,500 RPM electronic variable speed
- Electronic speed control maintains desired speed under load
- Super Joint System helps prevent kickback while protecting gears

116399..... **\$179.99**
 Replacement Carbon Brushes (set)
 116404..... **\$12.95**



6" Makita® 9566CV SJS Angle Grinder

- 12 AMP motor
- 4,000-9,000 RPM electronic var. speed
- Constant speed control maintains desired speed under load
- SJS mechanical clutch system helps prevent kickback
- Zig-zag varnish protects armature coil for longer tool life

116383..... **\$209.99**
 Replacement Carbon Brushes (set)
 116404..... **\$12.95**
 Grinder guard
 165346..... **\$19.99**



5" Metabo® WEV10-125

- 9.5 AMP motor
- 2,800-10,500 RPM electronic variable speed
- Electronic speed control maintains speed under moderate load
- Up to 20% more overload capacity in extreme applications
- Anti-vibration systems

101218..... **\$175.85**
 Replacement Carbon Brushes (set)
 316065..... **\$12.95**

metabo®



5" Metabo® WEV15-125 Quick

- 13.5 AMP motor
- 2,800-11,000 RPM electronic variable speed
- Electronic speed control maintains desired speed under load
- Up to 50% more torque than previous generation
- Automatic safety slip clutch protects from kickback

101217..... **\$261.45**
 Replacement Carbon Brushes (set)
 316065..... **\$12.95**

metabo®



5" Metabo® WEV15-125 HT

- 13.5 AMP motor
- 2,800-9,600 RPM electronic variable speed
- Electronic speed control maintains speed under moderate load
- Up to 20% more power than previous models
- Reduced grip diameter for improved ergonomics

101216..... **\$199.99**
 Replacement Carbon Brushes (set)
 316065..... **\$12.95**

SINGLE SPEED GRINDERS



- 4 1/2" Makita® 9557PB Angle Grinder**
- Extra large paddle switch for easy operation right or left handed.
 - Ergonomic barrel grip
 - High power-to-weight ratio. Lock-on button.
 - 7.5 AMP, 10,000 RPM
 - Spindle lock. Double insulated.

955700..... **\$122.00**
 Replacement Carbon Brushes (set)
 690860..... **\$5.95**



- 5" Makita® GA5010Z Angle Grinder**
- 10.5 AMP motor
 - 11,000 RPM
 - Grinder head rotates 90 degrees left or right for operator convenience
 - Super Joint System helps prevent kickback while protecting gears

790130..... **\$173.95**
 Replacement Carbon Brushes (set)
 115944..... **\$9.95**

TOOL SCHEMATICS AVAILABLE: GranQuartz.com



- 5" Makita® 9005B Angle Grinder**
- Powerful 9 AMP motor.
 - 10,000 RPM
 - Lightweight.
 - Ball bearing construction.
 - AC/DC lock-on switch.
 - Standard 5/8"-11 UNC spindle.
 - Double insulated.

116387..... **\$173.20**
 Replacement Carbon Brushes (set)
 116391..... **\$7.50**

LARGE GRINDERS AND SANDERS



- 6" Metabo® WEP17-150 Quick RT Grinder**
- 14.5 AMP motor
 - 9,600 RPM
 - Non-locking trigger
 - "Rat tail" ergonomic body design
 - 6.2 lbs.

601078..... **\$297.95**
 Replacement Carbon Brushes (set)
 316065..... **\$12.95**



- 7" Makita® GA7021 Grinder**
- 15 AMP motor
 - 6,000 RPM
 - Grinder handle rotates 90 degrees left or right for operator convenience

116577..... **\$199.99**
 Replacement Carbon Brushes (set)
 116409..... **\$23.95**



- 7" Makita® GA7911 Sander**
- 15 AMP motor
 - 6,000 RPM
 - Rugged housing for long life
 - Spindle lock for easy wheel changes

116382..... **\$241.95**
 Replacement Carbon Brushes (set)
 181047..... **\$9.95**



Metabo® 603825750 Rsev 19-125 Concrete Grinder

- Great for spot sanding and removal of concrete and coatings using a diamond cup wheel.
- High torque, 1,900 Watt motor
 - Ergonomically designed slim grip
 - Vario Tacho Constamatic (VTC) electronics
 - Electronic soft-start for smooth start up
 - 12 lbs.

825750..... **\$475.25**

NEW!



- 9" Makita® GA9060 Grinder**
- 15 AMP motor
 - 6,600 RPM
 - Grinder handle rotates 90 degrees left or right for operator convenience
 - Weight: 12.1 lbs.

906000..... **\$219.00**

ELECTRIC WATERFED POLISERS



WET



4" Makita® PW 5001 C Polisher

- 7.9 AMP motor
- 2,000-4,000 RPM
- Overload protection
- GFCI

116372..... **\$329.99**
 Replacement Carbon Brushes (set)
 116404..... **\$12.95**



WET

metabo



4" Metabo® PWE 11-100 Polisher

- New VTC Electronics with Power Interruption Protection
- Soft start with overload protection
- Variable speed stabilization
- 1750-5400 RPM • Built-in GFCI
- 9.6 AMP motor

790223..... **\$319.50**
 Replacement Carbon Brushes (set)
 790226..... **\$10.95**

FLEX



WET

5" Flex® L 12-3 100 Speed Wet Polisher

- 3,700 RPM
- 9.3 AMP motor
- Use Wet or Dry
- Soft start with overload protection
- Weight: 5.3 lbs.

116699..... **\$324.99**
 Replacement Carbon Brushes (price ea.)
 900123..... **\$12.85**

FLEX



WET



5" Flex® LE 12-3 100 Speed Wet Polisher

- New water feed and flow control under motor housing with upgraded water connection and 6 1/2' flexible hose.
- 1,200 – 3,700 RPM
 - 9.3 AMP motor
 - Use Wet or Dry
 - Soft start with overload protection
 - Weight: 5.3 lbs.

116615..... **\$369.00**
 Replacement Carbon Brushes (price ea.)
 900123..... **\$12.85**

FLEX

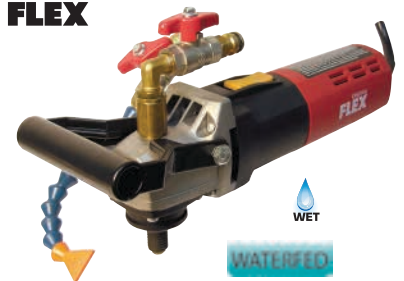

WET



5" Flex® LW 1509 Polisher

- 7.1 AMP motor
- High speed grinder
- 8,300 RPM
- Center and external water feed
- Built-in GFCI

116002..... **\$459.95**
 Replacement Carbon Brushes (price per pair)
 690793 (pair of brushes) ... **\$14.73**

FLEX



WET

5" Flex® LW 1503 Polisher

- 7.4 AMP motor
- 3,700 RPM
- Center water feed
- Built-in GFCI

116054..... **\$319.99**
 Replacement Carbon Brushes (price per pair)
 690793 (pair of brushes) ... **\$14.73**

ALPHA



WET



5" Alpha® VSP 320 Polisher

- Variable speed 700-2,500 RPM
- Specially coated spindle reduces friction, extends life of seals
- Adjustable splash guard and ventilation cap help keep water out of motor housing
- 15' Hose length w/Easy On, Easy Off sleeve for better mobility
- Inline GFCI

104569..... **\$355.30**
 Replacement Carbon Brushes (set)
 210048..... **\$10.95**

PNEUMATIC WATERFED POLISERS & GRINDERS

Pearl® WP3000
5" Pneumatic Wet Polisher

The Pearl WP3000 Pneumatic Polisher is the premier wet polisher for the stone & countertop fabrication trades. The WP3000 is designed to polish natural stone, quartz and engineered stone materials and is a high quality tool engineered for professional use.

- Air consumption: 16 cfm
- Air pressure: 90 psi
- RPM 5,500
- Shaft: 5/8 - 11"
- Made in Japan

100110..... **\$339.95**



PEARL



High Quality Flexible Air Hose

NEW & IMPROVED WATER HOSE
HIGH QUALITY FLEXIBLE HOSE ALLOWS FOR BETTER WATER FLOW!



Spindle Lock for easy & rapid tool removal



New Upgraded Hose Fittings

Cyclone® MVP
5" Pneumatic Wet Polisher

The Cyclone MVP Polisher is the first completely hand assembled polisher for the highest quality available. More power and dependability make the MVP the industry's most exciting new entry into the wet polishing market. Includes an innovative automatic oil injection system with a visible level chamber to keep it in top form under the most demanding use.

- Air consumption: 16 cfm
- Air pressure: 90 psi
- RPM 5,500
- Shaft: 5/8 - 11"
- Air inlet: 1/4" npt
- Weight: 5.06 lbs
- Rear exhaust



106288..... **\$329.00**

Pneumatic Tool Lubricant

Formulated to ISO 46 standards.

- 16 oz. bottle
- Inhibits rust, non-corrosive

Stock No. Price
600670..... **\$9.49**



Assassin®
5" Waterfed Air Polisher

- Center water feed with side exhaust
- 16.2 CFM air consumption, 90 PSI
- Lightweight, compact
- 4,500 RPM

600602..... **\$171.95**



Pro Series®
5" Waterfed Air Polisher

- Center water feed with rear exhaust
- 15.9 CFM air consumption with 90 PSI
- Lightweight, compact design
- 5,000 RPM

600600..... **\$206.95**



Alpha®
Air 830
5" Pneumatic Wet Polisher

The Alpha AIR-830 Polisher has a newly developed motor with a 5 hybrid vane design that outputs more power and lasts longer. Includes a 15' all-weather hoses with flexibility down To - 40°F or +140°F. Enhanced spindle shaft for easy tool removal (wrench included).

- No-Load RPM: 4,000
- Newly developed motor produces more power
- Central water-feed

119739..... **\$475.00**



Alpha® Air 850
5" Pneumatic Wet Polisher

The Alpha AIR-850 Polisher has a newly developed motor with a 5 hybrid vane design that outputs more power and lasts longer. Includes a 15' all-weather hoses with flexibility down To - 40°F or +140°F. Enhanced spindle shaft for easy tool removal (wrench included).

- No-Load RPM: 5,500
- Newly developed motor produces more power
- Central water-feed

119740..... **\$475.00**

AIR-830



4,000 RPM Gear Set

Ergonomic and lightweight for better maneuverability

Silicon Gear Head Cover

Provides Cushion & Keeps Hands Warm

New Splash Guard

Visibility Without Being Splashed

Newly Developed Motor

Produces More Power

5,500 RPM Gear Set



AIR-850

Optional C-Handle



Enhanced Spindle Shaft for Easy Tool Removal
(Wrench Included)



SEE IT IN ACTION

Scan to watch the video of AIR-830 / AIR-850



PSC-600

HIGH-PERFORMANCE PNEUMATIC CUTTER

Combined **power** and **comfort** for the best **results**



Lightweight For Better Maneuverability

Newly Developed Motor Produces More Power 8,500 RPM

Composite End Case to Prevent Freezing Hands

6" (150mm) Blade Capacity

Spring Return Throttle to Avoid Accidental Start

ALSO GREAT FOR GRINDING

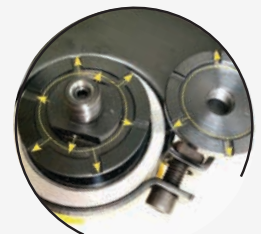

Center Water-Feed System
to Deliver Ample Water Regardless of Position



SEE IT IN ACTION



Scan to watch the video of PSC-600

TOOL SCHEMATICS AVAILABLE: GranQuartz.com



5" Barranca® BD-2321WR Polisher

- Speed- 5,500 RPM
- 16 CFM air consumption
- 90 PSI air pressure
- Center water feed with rear exhaust

600500.....\$379.95

ALPHA®



Alpha® AIR-300 Waterfed Mini Polisher

A smaller version of the well-known Alpha AIR-658. The Air-300 is designed to use in tight corners and for bowl polishing with easy maneuverability.

- 5,800 RPM
- 10 CFM air consumption
- Weight 1.6 lbs

116324.....\$420.00

GranQuartz® DIAREX®



7" Diarex® Pneumatic Wet Grinder

- 6,500 RPM
- 17.7 CFM air consumption
- 90 PSI air pressure
- Center water feed

600575.....\$279.00

GranQuartz® DIAREX®



5" Diarex® Pneumatic Wet Grinder

- 11,000 RPM
- 16.2 CFM air consumption
- 90 PSI air pressure
- Center water feed

600550.....\$206.95



5" Barranca® Pneumatic Wet Grinder

- 10,000 RPM
- 15 CFM air consumption
- Weight: 4 lbs.
- 90 PSI
- 5hp min. air compressor required

600513.....\$374.95

ALPHA®



801300

Alpha® PSG-125 High Performance Pneumatic Grinder

Adjustable rotating exhaust and built-in oil port makes this tool great for any environment with a wet cutting kit available & specialty kits for various applications.

- Powerful 1.4 HP motor with speed control governor
- 33 CFM air consumption, 90 PSI
- Reversible safety lever throttle
- Weight: 4.6 Lbs.
- Built-in oil port for daily maintenance
- Adjustable rotating exhaust
- Max Disc capacity: 5" x 1/4" x 7/8"



801301



801302

Stock No.	Description	Price
801300	PSG-125 Grinder.....	\$695.00
801301	PSG-125 Diamond Cutting Kit	772.92
801302	PSG-125 Grinding Kit	785.65

ALPHA®



Alpha® PSC-150 6" Pneumatic Saw

For cutting granite, marble, engineered stone and other hard surfaces. Use for cutting sink holes, groove cutting, rodding applications and for making precise miter cuts.

- 2 Hp Motor
- 90 PSI, Air consumption: Min- 32.8 CFM/1 Hp, Max- 48 CFM/2 Hp
- No load RPM: 8,500
- Cuts Miters in 3cm material
- Weight: 10.14 lbs.

Stock No.	Description	Price
116736	Alpha PSC-150 Saw	\$690.00

Alpha® WBC5KIT Wet Cutting Kit

Designed to convert a high-speed angle grinder into a wet tool. Kit includes: safety guard, Loc-Line Assembly, plastic tie, stainless steel collar, plastic collar, adapter (1/4 NPT to M10*P.1.0), water hose assembly, Memory Wrap (3ft. / 1M), quick connect adapter, GFCI Plug (120V) & hook & loop tie.



111707

Stock No.	Description	Price
111707	WBC5KIT Kit for 5" Grinder.....	\$82.45
111708	WBC6KIT Kit for 6" Grinder.....	91.33

ELECTRIC DRY USE POLISERS & SANDERS



7" Metabo® PE 15-30 Angle Polisher

- 800 - 3,000 RPM
- 13 AMP motor
- High-torque planetary gear train
- Soft start with overload protection
- Built-in GFCI
- Weight: 5.3 lbs.

615300..... **\$304.25**



Flex® 6" PE14-2 150 Rotary Polisher

The PE14-2 is great for restoration polishing and the flat gear head reduces distance to work surface.

- 10 AMP motor
- 0-600-2,100 RPM with continuous speed control trigger for gentle start
- Max polishing pad diameter 6" and max back-up head pad diameter 8"
- Powerful 1400 watt motor

600027..... **\$429.95**



7" Makita® 9227C Polisher

- 10 AMP motor
- 600-3,000 RPM
- Electric speed control

116413..... **\$259.99**

Replacement Carbon Brushes (set)

115944..... **\$9.95**



Makita® GV7000C Variable Speed 7" Vertical Sander

- Soft start & electronic speed control
- Variable speed 2,500 – 4,700 RPM
- Motor over pad design for better balance and control
- 5/8" - 11 UNC Spindle
- 7.9 AMP motor

116414..... **\$233.95**

Replacement Carbon Brushes (set)

115944..... **\$9.95**



Makita® GV5010 5" Vertical Sander

- Ball and needle bearing construction for long tool life
- Motor over pad design for better balance and control
- M8 x 1.25 Spindle
- 4.2 AMP motor

955701..... **\$111.95**



Makita® GD0800C 1/4" Die Grinder

- 6.6 Amps for higher power grinding
- 1/4" Collet
- Electronic speed control maintains a constant speed under load

100251..... **\$299.00**



Makita® GD0601 1/4" Die Grinder

- Fast and efficient deburring and grinding
- 3 AMP motor delivers 30,000 RPM
- 1/8" collet cone available (optional accessory)

116692..... **\$159.95**

Makita® 9237CX3 Variable Speed Polisher Kit

9237CX3 Polisher has variable speed dial and trigger to enable user to match the speed to the application. Polisher has wire mesh intake covers to prevent wool fibers from entering the motor and improved cord guard for better flexibility and durability.

- Soft start & electronic speed control
- Lock-on button for continuous use operation
- Includes 7" wool bonnet compounding pad, 7" wool bonnet polishing pad and pad alignment/centering sleeve
- Variable speed 2,500 – 4,700 RPM
- 10 AMP motor
- 5/8" - 11 UNC Spindle

Stock No.	Description	Price
116851	Makita Polishing Kit	\$291.50
115545	7" Replacement Wool Polishing Pad	18.95



DUST CONTROL/CUTTING GUARDS



Makita

Makita® 5" Dust Extracting Tuck Point Guard

Works with Makita 5" SJS Angle Grinders for tuck pointing applications. The cover features adjustable depth stops for more efficient work.

- Easily adjustable depth setting for quick changes
- Adjustable depth stops
- Clear viewing window for improved visibility
- Plunge feature allows for easy material removal
- Includes hose holder that attaches to the grinder power cord for easy routing

Stock No.	Description	Price
196846	5" Dust Guard.....	\$124.99



Makita® Dust Shrouds

Makita Dust Shrouds feature universal mounts to accommodate all 4 1/2" and 5" Makita grinders. Soft brushes on the shroud's rim prevent dust from escaping and help move the tool over the surface. Standard hose fitting accepts most vacuum systems.

- 4-Spring suspension system
- Removable edge piece allows for surface work flush to other objects

Stock No.	Size	Price
104225	4 1/2 - 5"	\$55.55
104227	7"	\$69.95



Makita® 6" Grinder Guard

For use with Makita 6" Angle Grinders. Installs quickly and easily. Manufactured from high quality steel for added durability and long life.

- Installs quickly and easily
- High quality materials

Stock No.	Description	Price
165346	Cutoff Wheel Guard...	\$19.99



Makita® Dust Extracting Cutting Guard

For use with most Makita 4-1/2" and 5" angle grinders (excluding model 9005B). Durable construction.

- Quick, easy installation
- High quality material

Stock No.	Description	Price
198415	Dust Guard.....	\$81.95



Metabo® Dust Shroud

With flexible brush rim for use with angle grinders.

- Quick, tool free installation
- Anti-static synthetic material
- Connection port: 35/41mm

Stock No.	Description	Price
569339	Dust Shroud	\$98.95

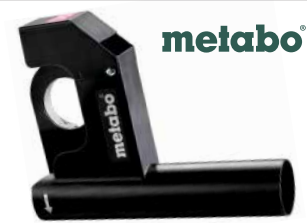

Metabo® Dustless Tuck Point Guard

For quick removal of mortar joints with optimal view of working area. Cleaning flap for quick, tool-free access for disc change.

- 58 mm Connection

Stock No.	Description	Price
628621	Tuck Point Guard ..	\$104.50

Alpha® EcoGuard

Alpha introduces a new EcoGuard designed for collecting dust when using a High-Speed Angle Grinder. For use when grinding with wheels up to 5" in diameter. Made of high-quality construction for heavy duty applications, the cover creates a virtually dust-free environment when connected to a vacuum.

- Clear cover for better visibility
- Easy to install and replace grinding wheels
- Removable front piece for edge grinding

Stock No.	Description	Price
933560	EcoGuard Type G	\$116.75
933558	EcoGuard Type G w/Connector Hose Kit.....	135.70



Alpha® EcoGuard W6

Designed for collecting dust when grinding with wheels up to 6" in diameter. EcoGuard W6 creates a virtually dust-free environment when connected to a vacuum.

- Clear cover for better visibility
- Easy to install and replace grinding wheels

Stock No.	Description	Price
933566	EG W6 w/Connector Hose Kit.....	\$147.20
526000	Flexible Tapered Hose Kit, 18" L.....	16.00

BACKUP HEADS/BACKER PADS



Aluminum 3" Ogee Backer Head

The curve in the edge of the 3" backer head directs a 4" pad into the concave portion of an Ogee profile allowing full pad contact with the stone surface.

Stock No.	Diameter	Price
912109	3"	\$19.03

Weha® Flexible Backer Pads

For use with Velcro® backed silicon carbide sandpaper. The pad's 5/8" thick yellow foam provides cushion for the sandpaper to roll over the edges and inside radius cuts. High quality and excellent performance with Velcro backing.

Stock No.	Diameter	Price
004440	4"	\$14.28
004441	5"	15.30



BACKUP HEADS/BACKER PADS



Diarex® Flexible Backup Heads

- 5/8"-11 Thread
- Q.R.S. backed

Stock No.	Diam.	Price
912189	3".....	\$10.66
912190	4".....	13.05
912191	5".....	19.32



Ultra Light 4" Rigid Backup Heads

This is the lightest rigid backup head available.

- 5/8"-11 Thread
- Q.R.S. backed

Stock No.	Diam.	Price
912210	4".....	\$14.81



Diarex® Super Flexible Backup Head

- 5/8"-11 Thread
- Q.R.S. backed

Stock No.	Diameter	Price
912188.....	4".....	\$14.24

GranQuartz
DIAREX®



Diarex® Rigid Aluminum Backup Heads

- 5/8"-11 Thread

Stock No.	Diam.	Price
117158	3".....	\$19.03
117159	4".....	20.17
117160	5".....	21.42
105147	7".....	74.10



Dongsin® Backup Pads

- 5/8"-11 Thread



Stock No.	Diam.	Type	Price
122065	4".....	Rigid.....	\$17.95
122066	4".....	Flexible.....	17.95
122068	4".....	Sponge.....	20.95

Stock No.	Diam.	Type	Price
122069	5".....	Rigid.....	\$24.95
122070	5".....	Flexible.....	24.95
122071	5".....	Sponge.....	27.95

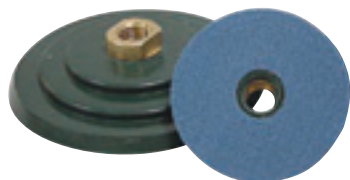

Rubber Backup Pads

Q.R.S. backed with no peel

Stock No.	Desc.	Price
696030	3" x 5/8-11.....	\$14.95
696062	4" x 5/8-11.....	18.99
696093	5" x 5/8-11.....	24.99

ALPHA®

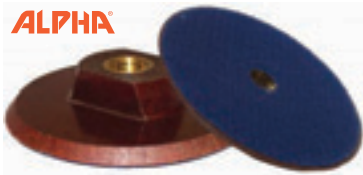

Alpha® Rigid Heads

Stock No.	Diameter	Price
116135	3".....	\$24.99
116184	4".....	26.95
116257	5".....	36.45
116185	Spacer.....	1.93

(for rigid backer heads)

ALPHA®



Alpha® Flexible Pads

- QRS-backed
- For use with any Q.R.S.-backed grinding or polishing disc
- 5/8"-11 thread (metric threads available on request)

Stock No.	Diameter	Price
116098	2".....	\$24.20
116099	3".....	24.99
116182	4".....	26.95
116192	5".....	40.55



Koltec® Straight Rotation Backup Heads

Stock No.	Desc.	Price
696025	3" x 5/8-11.....	\$17.30
696060	4" x 5/8-11.....	18.79
696091	5" x 5/8-11.....	22.95
696108	7" x 5/8-11.....	26.05

4" Wide Adhesive Velcro® Strips

- 4" Wx 12" L
- Adhesive Backed

Stock No.	Price
696469.....	\$5.27

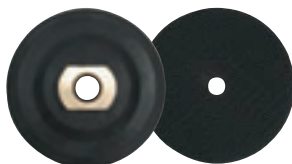
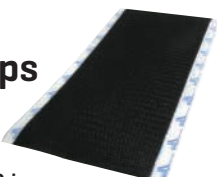

Soft Rubber Backup Pads

Stock No.	Diameter	Price
690243	4".....	\$18.99



Aluminum Backup Heads

Light weight, non-rust aluminum body, for use with any Velcro® backed grinding or polishing pads.

- 5/8"-11 thread

Stock No.	Diameter	Price
696023	3".....	\$19.99
696058	4".....	20.85
696089	5".....	25.95



Diskit Foam Rubber Backup Heads

- Tough and flexible polyester urethane foam body engineered for maximum tensile strength and elongation
- For use on most Q.R.S.-backed or self-adhesive grinding and polishing discs
- Maximum 10,000 RPM
- Flexible edge allows pad to conform to surface contours
- M8 x 1 1/4" for Makita GV5000/GV5010

Stock No.	Connection	Diam.	Description	Price
912118	5/8"-11 - F.....	4".....	Q.R.S.....	\$18.79
116806	5/8"-11 - F.....	5".....	Self-Adhesive.....	15.59
116798	5/8"-11 - F.....	5".....	Self-Adhes.w/Flex Edge.....	15.59
116809	5/8"-11 - F.....	5".....	Q.R.S.....	21.99
116802	M8-11/4" - M.....	5".....	Self-Adhesive.....	15.59
116814	5/8"-11 - F.....	7".....	Q.R.S.....	27.15
696104	5/8"-11 - F.....	7".....	Canvas -Flex.....	23.95
696105	5/8"-11 - F.....	7".....	PSA -Flex.....	28.15



Make nearly invisible seam edges, FAST!

(Electric Seam Phantom tool package includes toolbox, pneumatic version does not)



NSI Solutions Seam Phantom

The Seam Phantom® is an innovative system for producing nearly perfect seams in all types of stone and quartz. The system utilizes a diamond cup wheel followed by up to three (3) diamond abrasive and a precise depth adjustment to eliminate chips and produce a clean sharp edge. When the counter is assembled the result is a nearly invisible seam. The Electric Seam Phantom tool package includes a durable toolbox, the pneumatic version does not.

- Rigid design holds grinder at precise angle
- Use with a Glide Guide straight edge
- Produce precisely dressed, chip free edges
- Used to correct out of square or rough saw cuts on the jobsite

Stock No.	Description	Price
790420	Electric Seam Phantom Tool Pkg. (no grinder).....	\$1,580.00
790421	Air Seam Phantom Tool Pkg. (no polisher).....	1,480.00
790405	5/8"-11 Female Adaptor To Phantom Connection.....	49.95
790406	2" Cup Wheel SL3-CUP2	75.75
790407	3" Turbo Pad 60 GRIT SL3-60.....	39.95
790408	3" Turbo Pad 150 GRIT SL3-150.....	39.95
790409	3" Turbo Pad 300 GRIT SL3-300.....	39.95
171067	48" Glide Guide	121.00
790423	72" Glide Guide	193.00
790415	92" Glide Guide	250.00



Make consistently awesome cutouts, FAST!

NSI Solutions Sink Bull™

The Sink Bull™ is a machine specifically designed to quickly grind perfect, repeatable, cutouts for under-mount sinks. The Sink Bull™ rides on a simple, shop made template of plywood or plastic. Extremely stable in use, it grinds quickly and accurately when paired with our 3" Rapid Z-Cut™ bit.

- Create perfect, repeatable, sink cutouts using inexpensive shop made templates of plywood or plastic
- Powered by heavy duty, 15 amp Makita Grinder (model GA7021), sold separately
- Start with 3" Rapid Z-Cut bit for fast material removal (top bearing version)
- Finish with vacuum brazed drum wheel (top bearing required) to leave an easy to polish edge (3" Coarse and Fine included)
- Simple external water feed

Stock No.	Description	Price
790461	Sink Bull, Rapid Z-Cut, 3" Coarse & Fine Drum Wheels (No Grinder).....	\$1,995.00
790452	Rapid Z-Cut With Bearing.....	320.00
790454	NSI Rapid Z-Cut Replacement Blade	8.75
116577	Makita GA7021 Single Speed Grinder, 15 Amp*	199.99
790462	3" Drum Wheel With Top Bearing, Coarse.....	229.00
790463	3" Drum Wheel Replacement, Coarse, Drum Only	115.00
790464	3" Drum Wheel With Top Bearing, Fine.....	229.00
790465	3" Drum Wheel Replacement, Fine, Drum Only	115.00
790466	1" Drum Wheel With Top Bearing, Coarse.....	129.00
790467	1" Drum Wheel With Top Bearing, Fine.....	129.00

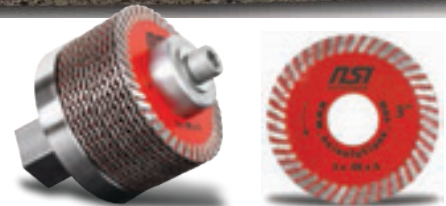

NSI Solutions Rapid Z-Cut™

Rapid Z-Cut™ was designed for shaping sink cutouts but is also great for other fabrication tasks. The combination of a corrosion resistant stainless steel arbor with center water feed and stacked 3" diamond blades allows for extremely fast stock removal, especially when used on The Sink Bull.

- Blades can be rearranged to correct "apple coring"
- Available with or without top bearing
- Replaceable 3" diamond blades
- 2-Stage template follower- the outer ring can be removed after the blades wear down (bearing version only)
- 5/8"-11 thread

Stock No.	Description	Price
790452	Rapid Z-Cut, w/Top Bearing.....	\$350.00
790453	Rapid Z-Cut, No Top Bearing	245.00
790454	(1)3" Diamond Replacement Blade	8.75

CIRCULAR SAWS

Makita

410000.....\$199.99

5" Makita® 4100KB Dry Masonry Saw

Powerful dry-cutting solution for tile, masonry and concrete with dust control features.

- 13 amp motor
- Dust extraction port swivels 360°
- Dust-protected trigger
- Transparent upper guard dust cover
- Large rubberized depth gauge lever for easy adjustments

FLEXTOOL
SCHEMATICS
AVAILABLE:
GranQuartz.com

WET

5" FLEX® CS40 Wet Saw

The CS 40 Wet Saw is equipped with a high quality water-feed system that eliminates harmful dust particles which occur when cutting stone surfaces. The CS 40 has the ability to accept a curved cutting blade thus making curve cutting operations safer and easier.

- Powerful 12 amp motor
- Built in GFCI
- Accepts curved cutting blades

Great for straight or curved blade cutting!

101062.....\$199.99

Replacement Carbon Brushes (price per pair)

710224.....\$14.40

**Skilsaw® SPT77W-227 1/4" Worm Drive Saw**

The Skilsaw Worm Drive has a Dual-Field motor that is designed especially for saws. It increases cooling and extends the life of the saw. A 51° bevel allows user to make a wide variety of cuts.

- Powerful 15 Amp motor
- Push button spindle lock for easy blade changes
- Cut-ready depth of cut system
- Anti-snap lower guard reduces snags

600165.....\$247.16

Makita**5.5" Makita® 5005B Circular Saw**

Makita's 5005BA 5-1/2" saw is a compact and versatile saw engineered for a range of applications.

- Powerful 8.0 amp motor
- Lock-Off button prevents accidental starts
- Blade is located on left side for better cut line visibility

116376.....\$298.00

Makita

WET

5" Makita® 4101RH Masonry Saw

The Makita 4101RH 5-in wet-cutting masonry saw is ideal for wet cutting of tile, masonry, concrete, and more.

- Wet cutting saw, 7.9 AMP
- Cover revents water from entering motor housing
- Includes 15 ft. of tubing, water pressure regulator and valve and GFCI

115951.....\$379.99

Makita**7.25" Makita® 5477NB**

- Powerful 15 AMP motor
- High quality, heat treated hypoid gears are engineered for long lasting performance
- 0° - 51.5° bevel capacity
- Large cutting capacity (2-3/8" at 90°, 1-3/4" at 45° and 1-9/16" at 50°)

900125.....\$172.95

Makita**4.375" Makita® 4100NHX1**

- 14,500 RPM
- 1-3/8" cutting depth
- Adjustable depth gauge for precision cutting
- Lock-off button helps to prevent accidental starts
- Includes socket wrench, spanner wrench, and two 4" diamond turbo blades

116213.....\$159.95

ALPHA

WET

4.5" Alpha® AWS 110 Wet Saw

- Wet cutting saw
- 11.2 AMP motor
- Includes GFCI, water valve and hose, straight cutting guide

900157.....\$167.85



Gison® Right or Left Hand 7" Wet/Pneumatic Saw

Specially designed for wet cutting granite, marble, quartz stone and engineered stone (with air). The Gison wet/air stone cutters accept up to a 7" blade, and are available in RIGHT or LEFT-hand cutting design.

- Center water fed design
- Maximum speed 7000 RPM
- Air Pressure: 90 psi, air consumption: 26.1 CFM

Stock No.	Description	Price
600898	Gison Right-Hand Saw	\$299.00
601010	Gison Left-Hand Saw	299.00



ALPHA



Alpha® PSC-600 6" Pneumatic Saw

High-performance pneumatic cutting tool with central water-feed that delivers plenty of water no matter the position. Newly developed motor for more power when cutting granite, marble, engineered stone and other hard surfaces. Use for cutting sink holes, groove cutting, rodding applications and for making precise miter cuts. Enhanced spindle shaft for easy tool removal and silicon covered gear head provides better ergonomic performance.

- 2 Hp Motor
- 90 PSI, Air consumption: Min- 32.8 CFM/1 Hp, Max- 48 CFM/2 Hp
- No load RPM: 8,500
- Cuts Miters in 3cm material
- Weight: 10.14 lbs.

Stock No.	Description	Price
119741	Alpha PSC-600 Saw	\$485.00

ALPHA



Alpha® ESC-125 Electric Wet/Dry Saw

For use on granite, quartz surfaces, marble, limestone, concrete and sintered slabs. Use for wet or dry cutting. Water-feed supply eliminates creation of harmful dust particles in the air.

- Precision Cuts Everytime.
- Powerful 1200W Motor
- Base plate allows guides to be used in multiple ways
- New clamping system ensures cutting stability
- Includes self-adhesive felt strips to protect work surface
- Built-In GFCI
- For use with curved or straight cutting blades

Stock No.	Description	Price
900674	Alpha ESC-125 Saw	\$258.25

PEARL



Pearl® VX5WV 5" Wet/Dry Saw

Pearl's VX5WV circular saw is for use on all tile, hard porcelain, natural stone and masonry. All-aluminum single piece blade guard accommodates up to a 5" diamond blade and it accepts contour cutting blades for fast, safe radius cutting. Includes a vacuum port compatible with 1-1/2" hoses, trigger lock and inline GFCI.

- Side handle for additional support
- Powerful 11 amp motor
- Over 4cm depth of cut with 5" blade
- Limited one-year warranty

Stock No.	Description	Price
679977	Pearl VX5WV Wet/Dry Saw	\$289.00

Eibenstock® 5" Wet/Dry Saw

High performance wet/dry saw designed and manufactured in Germany.

- Accepts curved cutting blades for fast, safe radius cutting
- Roller guide smoothly guides saw and protects surface
- Adjustable cutting depth up to 1-3/8"
- Built-in GFCI
- Made in Germany
- Limited 1 year warranty



Great for straight or curved blade cutting!



Stock No.	Description	Price
125001	Eibenstock 5" Wet/Dry Saw	\$399.00



Blue Ripper G2 Rail Saw

The new Blue Ripper G2 Rail Saw is a timing-belt driven rail saw with a unique stainless steel coolant-through spindle design. Easy to use, the saw weighs only 32 lbs. with motor and blade and is powered by most available grinders.

- Accepts 6" – 10" blades
- Standard 7/8" arbor
- 1 Year limited warranty
- Up to 6' per minute cutting speeds
- Uses the same rails as the Blue Ripper Sr. & Blue Ripper Jr. (sold separately)

Stock No.	Description	Price
196243	Blue Ripper G2, With Motor/No Rails.....	\$2,625.00
196244	Blue Ripper G2, With Motor and Rail Kit.....	3,590.00
196245	Blue Ripper G2 Miter Base	495.00



Blue Ripper Senior Rail Saw

The Blue Ripper Senior is a precision rail saw system with a 10' quick-connect water hose with inline ball-valve shutoff.

- Includes a 14" J slot granite blade & GFCI
- 7ft. Stainless steel rail
- 13ft. Stainless steel rail

Stock No.	Description	Price
693714	Rail Saw System, 220V,3HP,148" & 92" Rails	\$5,240.00
693849	Rail Saw System, 5HP, No Rails.....	4,545.00
693715	Rail Saw System, 3HP, No Rails.....	4,275.00
693635	Blue J Slot Blue Ripper Blade, 14" Diam.	194.25
692671	Rail only, 148"	640.00
692670	Rail only, 92"	380.00
790208	Rail Saw System, 230V, 5HP, 148" & 92" Rails.....	5,510.00

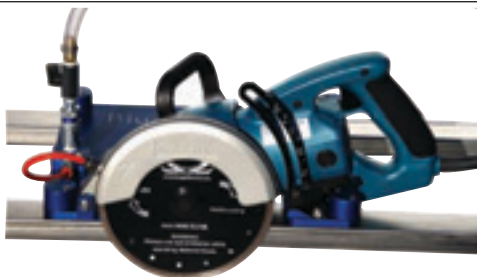

Blue Ripper Jr. Rail Saw

Makes full plunge cuts up to 4cm. deep. Up to 4 FPM cut speed, single pass through 2cm absolute black.

- Makita 5477NB Saw with 4,300 RPM motor
- Accepts up to 8" blade
- Standard 5/8" arbor
- One-hand water disconnect
- Weight: 19.8 lbs.
- Made in U.S.A.

Stock No.	Description	Price
693712	Blue Ripper Jr. Rail Saw.....	\$2,540.00
693711	Blue Ripper Jr. Only (No Rails).....	1,575.00

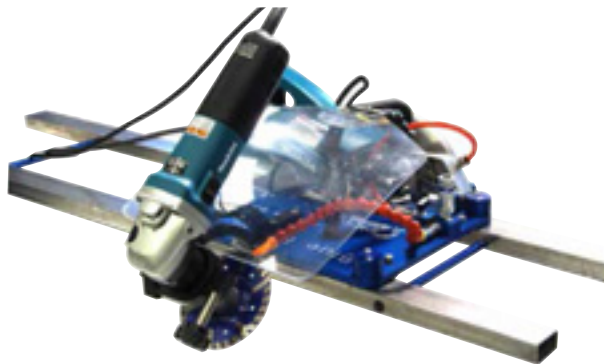

Eagle Edger Jr. Attachment

With the New Eagle Edger Jr. 0-91 degree edge guide attachment you can bevel, flush seams and edge polish (does not include rails).

Note: this is an optional ATTACHMENT for your existing Blue Ripper Jr. Rail Saw system and does not include the Blue Ripper base plate system or a Blue Ripper Jr.. Picture shows Eagle Edger Jr. added to Blue Ripper Jr. Rail Saw.

Stock No.	Description	Price
790203	Eagle Edger for Blue Ripper Jr.....	\$1,185.00

2018 Blue Ripper Miter Master Rail Saw

The Blue Ripper Miter Master uses 2 Makita GA7021 grinders to cuts BOTH 45° angles simultaneously.

- One hand water disconnect
- 10ft. water hose
- Fits all Blue Ripper Rails
- GFCI protection

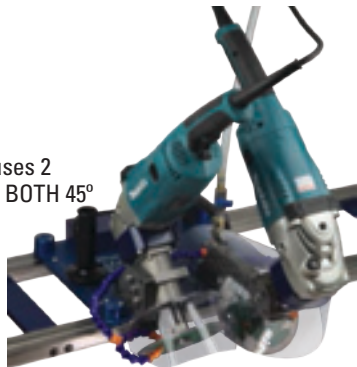

Stock No.	Description	Price
090969	Blue Ripper Miter Master(No Rails).....	\$2,700.00
439200	Miter Master Upgrade Kit for GA7021	325.00

Omega® Red Ripper Ultra-Light Router

For profiling sinks and edges & perfect for pre-fabs. The built-in hydroplaning base helps the router move smoothly over the surface of the stone without scratching. Works great on both natural and engineered stone surfaces.

- Powered by a Makita 9564CV grinder
- Weight: 11 Lbs.
- Fits standard 7/8 bore bits with M10-1.5 bolt
- One-hand water disconnect



Stock No.	Description	Price
790215	Red Ripper Ultra-Light	\$1,210.00
949931	Red Ripper Ultra-Light w/Waterfeed ...	1,340.00

NEW!



Blue Ripper Miter Master Rail Saw for Porcelain

Specialized light-duty (28 Lb.) version of the Blue Ripper Miter Master for cutting porcelain, large format tile and other thin materials. Uses 2 grinders simultaneously to cut BOTH matched 45° angles.

- One hand water disconnect
- 10ft. water hose
- Fits all Blue Ripper Rails
- GFCI protection
- Weight: 28 Lbs.

Stock No.	Description	Price
699209	Blue Ripper Miter Master, Porcelain (No Rails).....	\$2,449.05



Pearl® VX 10RS 10" Rail Saw

The Pearl VX 10RS Rail Saw is designed for versatility and features folding legs that tuck under the saw when ready to transport. The cutting table has holes that divert the water and waste material away from work surface and into the slurry pan, away from the floor.

- Powerful 1-1/2 HP
- Position lock cutting head
- Rubber matted cutting table
- Sturdy wheels for easy transport
- Removable extension table adds extra workspace
- Splash guard reduces overspray
- Blade capacity of 10" enhances cutting capacity

698609.....	\$1,350.00
-------------	-------------------

Pearl® PA7 Pro 7" Professional Tile Saw

INCLUDED WITH SAW!

HIGH PERFORMANCE BLADE and HEAVY DUTY STAINLESS STEEL WATER TRAY

698558
Tile Saw Stand **\$125.95**



CHOPPING ACTION: Plunge feature allows the user to make quick plunge cuts with the spring loaded cutting head.

TRACKING SYSTEM: 8-sealed metal roller bearings and stainless steel rails allow the table to roll smoothly, ensuring accurate cuts.

- Cutting is done over the pan and drip trays containing the water run off
- The table travels 50% less than conventional saws.
- Increased accuracy
- Being able to work in smaller spaces
- Heavy duty stainless steel water tray included - high durability tray for heavy duty jobs
- Steel frame and cast aluminum components
- Powerful 1HP motor with re-usable air filter
- Water pump included
- Table retention device secures the cutting table when transporting the saw

677280.....	\$675.00
-------------	-----------------

Pearl® VX 10.2 XL Pro Kit Professional Tile Saw



NOW INCLUDED!

HIGH PERFORMANCE BLADE and DRIP TRAY

2 HORSEPOWER INDUCTION MOTOR

HEAVY DUTY ON/OFF SWITCH

STAINLESS STEEL RAIL GUIDES

10-SEALED METAL ROLLER BEARINGS



- High torque 2 HP induction motor, fully enclosed, fan cooled
- Patented telescoping table makes big cuts
- 10-Sealed metal roller bearings for a smooth rolling table and long life
- Stainless steel telescoping rail guides ensure precise alignment and precision cutting

Stand Included



698608.....	\$1,079.00
-------------	-------------------

- Powerful 3 HP 15 AMP Motor
- Air Filter That is Easily Maintained & Protects Motor
- Spring Loaded Cutting Head For Chop Saw Action
- 3-Locking Head Positions (Lowest - Middle - Upper).
- Sturdy Handles for Ease of Chop Saw Action
- Metal Table Rollers For Strength & Durability
- Dust Deflection Stainless Steel Plate
- Table Lock

CUTTING CAPACITY:
8" x 8" x 16"

TRACKING SYSTEM INCLUDED WITH SAW: Professional Diamond Blade, 45°/90° Rip Guide, Owner's Manual & Warranty Card

One year limited warranty

2 HP induction motor, 115v/230v, 60Hz, single phase, 3,600 rpm with thermal overload protection

Pearl VX141MS

14" Professional Masonry/Brick Saw



14" PROFESSIONAL DIAMOND BLADE INCLUDED!

990310.....\$929.95

- Powerful 2 HP Induction Motor
- Belt Driven
- Dual Voltage (110V & 230V).
- Spring-Loaded Cutting Head for Chop Saw Action
- Table Lock
- Weight: 110 LBS.

CUTTING CAPACITY:
8" x 8" x 16"

TRACKING SYSTEM INCLUDED WITH SAW: Professional Diamond Blade, 45°/90° Rip Guide, Owner's Manual & Warranty Card

One year limited warranty

2 HP induction motor, 115v/230v, 60Hz, single phase, 3,600 rpm with thermal overload protection

VX141MSPRO

14" Professional Masonry/Brick Saw



698558.....\$125.95
Stand Sold Separately

990311.....\$1,395.95

Achilli® ANR Series Portable Stone Saws

Achilli's ANR series stone saws feature high quality construction and are made in Italy. ANR series saws are Achilli's mid-level bridge saws with powerful 220 V, single phase, 3 HP motors that are designed for cutting all stone surfaces. The onboard water tank reservoir includes a recycling pump to feed water up through the blade housing and channels it to the blade from both sides, keeping it cool during use. The ANR 200 makes 78" useful cuts, while the ANR 130 makes 51" cuts. Height adjustment of the cutting head is controlled by a manual hand crank when cutting materials of various thicknesses. A great saw for cutting granite on site with multi-functions to perform horizontal cutting and slotting.

- Galvanized steel rail work table with one extension table
- Transport handle with adjustable squaring bar
- Double rhomboid bridge design for high resistance & accuracy
- Water tray & recycling pump are self-contained for total portability
- Folding legs for ease of transportation
- Accepts 10", 12" or 14" blades
- 3,400 RPM, 3 HP

Stock No.	Description	Price
444084	ANR 130 Stone Saw.....	\$4,230.95
052153	ANR 200 Stone Saw.....	5,789.95
444085	Achilli Extension Table	137.95



Exclusively At GranQuartz



Tilting Bridge

Exclusively At
GranQuartz

Achilli® TAG Series Portable Stone Saws

TAG series saws are Achille's entry level, Italian-made bridge saws with a powerful 220 Volt, single phase, 3 HP motor designed for cutting all stone surfaces. The TAG's onboard water tank reservoir includes a recycling pump to feed water up through the blade housing which is then channeled to the blade from both sides, keeping it cool during use. Height adjustment of the cutting head is controlled by a manual hand crank. Plunge cuts and step cutting operations are easily achieved using the height adjustment feature as well and the entire beam tilts for precision miter cutting. The TAG series are equipped with a soft on/off button next to the blade.

- Galvanized steel rail work table
- Transport handle with adjustable squaring bar
- Double rhomboid bridge design for high resistance & accuracy
- Water tray & recycling pump are self-contained for total portability
- Folding legs for ease of transportation
- 3,400 RPM, 3 HP

NEW!



Stock No.	Description	Price
444083	TAG 130 Stone Saw.....	\$2,637.95
053330	TAG 150 Stone Saw.....	3,780.95
053342	TAG 200 Stone Saw.....	4,784.95
444085	Achilli Extension Table	137.95

Achilli® ATS Series Tile Jobsite Saw

Achilli's The Achilli ATS wet tile saw is an outstanding job site saw for cutting stone, porcelain, ceramic, terracotta, concrete. ATS Series tile and stone saws are perfect for 3/8" to 1/2" material. The ATS wet tile saws are designed and built for years of service under the harshest of shop conditions. The Achilli ATS wet tile saw is made in Italy with premium quality materials.

- ATS 80: 31" (800mm) length of cut
- Manual head feed by hand.
- Tilting bridge for 45° cutting.
- Motor: single-phase, 110v, 3400 rpm - 1.5 hp
- Accepts an 8" x 1" (203mm 25mm) blade
- Water tank with built-in recycling pump.
- Manual depth adjustment by toggle-lever mechanism.
- Legs can be folded to facilitate transportation.
- Side extension table (optional) can be mounted to both sides of the machine.

NEW!

Exclusively At
GranQuartz



Stock No.	Description	Price
052158	ATS 80 Stone Saw.....	\$1,954.95
053334	ATS 130 Stone Saw	2,147.95

Achilli® AMS Series Single-Bridge Jobsite Saws

Achilli's AMS series portable bench stone saws are compact and sturdy stone fabrication machines designed with a sliding cutting head. Stone cutters and installers can use this machine as a wet stone saw for cutting granite, marble, engineered stone and tile surfaces. AMS series jobsite bridge saws provide a high level of accuracy when cutting stone and other materials and feature:

- Depth Adjustment: manually adjustable cutting depth by means of the "plunge" cutting mechanism
- Worktable: galvanized steel worktable with rail width of 21" (AMS 100) or 26" (AMS 130)
- Tilting Bridge: make cuts from 90° to 45° using the bridge tilt feature
- Built in recycling pump in the water tank for cooler cutting
- Portability: folding legs for ease of transportation
- Blade diameter: 10" - 14"
- Optional extension table available
- 3,400 RPM, 3 HP

NEW!

Achilli
SOLUTIONS IN STONE TECHNOLOGY

Exclusively At
GranQuartz



Stock No.	Description	Price
053333	AMS 100 Stone Saw	\$2,746.95
444081	AMS 130 Stone Saw	2,932.95



Tilting Bridge



Control Panel



Exclusively At
GranQuartz

Achilli® AFR 300 A-ZM Fixed Bridge Saws with Laser

This machine is great for use in small and large fabrication shops because of its configuration. The AFR A300 A-ZM fixed bridge saw is equipped with a number of features and offers optional features as well. The standard and optional features include:

- Motorized head feed with variable speed in both directions for total operator control
- Work table made of powder-coated stainless steel rails to withstand the harshest shop conditions
- Two extension Tables: 31.5" X 23" and a side stop, allowing the option of adding more tables
- Motorized cutting depth adjustment provided by geared motor
- 90° to 45° Bridge tilt allows manual bridge tilt for making precise cuts
- 3,400 RPM, 7 HP
- Accepts 10" - 14" diameter blades
- Makes 10' useful cuts
- Includes Laser

Stock No.	Description	Price
053307	AFR 300 A-ZM Bridge Saw	\$18,665.95



Tilting Bridge



Achilli® AFR 300C Fixed Manual Bridge Saw

The AFR 300C fixed bridge manual saw is a compact and sturdy saw with a fixed bridge. The bridge tilt and the water tank with built-in recycling pump make it suitable for workshops. It is equipped with 2 extension tables to increase stability and facilitate the movement of the work pieces. The standard and optional features include:

- Manual feed head with variable speed in both directions so the operator has control
- Worktable is made of galvanized steel rails with powder finish for durability in all conditions
- Saw is equipped with No. 2 side extension tables 31.5" x 23" and side stop, therefore it is expandable.
- Cutting Depth Adjustment - Another manual feature is the cutting depth adjustment
- Manual bridge tilts 90° to 45° for precise cutting
- Useful cut length: 10'
- 3,400 RPM, 4 HP

Stock No.	Description	Price
052151	AFR 300 C Bridge Saw.....	\$11,758.95

Exclusively At
GranQuartz



Tilting Bridge



Control Panel



Achilli® AFR 350A Single-Bridge Jobsite Saws

The AFR 350A is Achilli's high end bridge saw designed for use in small and large fabrication shops. Additionally, The AFR 350A fixed bridge saw is equipped with numerous features and also offers optional add-on capabilities as well. Standard features include:

- Motorized head feed with variable speed in both directions for total operator control
- Work table made of galvanized steel rails with powder finish to withstand the harshest shop conditions
- Two extension Tables: 31.5" X 23" and a side stop, allowing the option of adding more tables
- Motorized cutting depth adjustment provided by geared motor
- 90° to 45° Bridge tilt allows manual bridge tilt for making precise cuts
- 3,400 RPM, 7 HP
- Accepts 10" - 14" diameter blades
- Makes 11' 4" useful cuts

Stock No.	Description	Price
053308	AFR320A Bridge Saw.....	\$23,071.95

Achilli® CMS Wet Saw

This water circulating wet 14" sliding wet saw has a powerful 3 HP 220 V 13.5 amp motor delivering 3400 RPM for the most powerful output with durability for cutting backsplash or aprons. The CMS is a perfect fit for all shops that own a inline splash machine. Use the CMS instead of a bridge to increase production for countertops and save labor by having a designated splash cutting saw.

- Galvanized steel frame structure is extremely durable
- Tools: includes necessary blade and bolt wrenches
- Built in water tank with recycling pump cools the blade
- Water tank has a built in recycling pump providing the blade with a continuous supply of water
- Optional 47" side extensions which may be "chained" together for a maximum length of 126" from end to end



CMS saw with optional 47" side extensions



Laser



Extension Table



Roller Extension Table

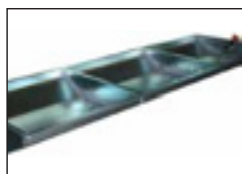

Water Receptacle



Hydraulic Pop-Up Rollers



Achilli® TFM Fixed Bridge Thick Stone Saw

This fixed bridge, thick stone saw is equipped with compressed, rectified, and chromed "active beam" for accuracy. Worktable extensions widen the workbench easing the movement of slabs in small spaces and a particular device facilitates the execution of parallel cuts. The TFM has a 10Hp, 3,400 RPM motor with a useful cutting length of 10' 2" and is configurable. Standard and optional features:

- Frame - Sandblasted and ceramic coated steel frame.
- Head Motion - Motorized head feed with variable speed in both directions so the operator has control.
- Cutting Depth Adjustment - Motorized cutting depth adjustment along Z axis by geared motor.
- Worktable - The worktable is made of galvanized steel rails, hence it is durable.
- Head Tilt - Due to the manual head tilt for cutting from 90° to 45° fabricators are able to make precise cuts.
- Extensions & Side Top - Equipped with no. 6 worktable extensions and side stop
- Parallel cut device available for the execution of parallel cuts



Parallel Cutting Device Accessory

Stock No.	Description	Price
052152	TFM Thick Stone Saw.....	\$33,048.95
053301	Motorized Pop-Up Rollers.....	5,066.95
053302	Manual Pop-Up Rollers.....	4,536.95
053300	Water Tray w/Recycling Pump.....	2,194.95

Stock No.	Description	Price
053305	Laser for TFR-A/TFM Saws.....	\$1,213.95
053306	Parallel Cutting Device.....	3,128.00
053304	Side Extension Table, No Rollers.....	1,322.95
053303	Side Extension Table, With Rollers.....	1,296.95



Laser



Extension Table



Roller Extension Table



Achilli® TFR-A Bridge Saw

The Achilli TFR A Granite and Stone Bridge Saw is the perfect solution for shops fabricating Granite, Quartz, Quartzite and other hard surfaces and high production shops that need extra cutting and fabrication speed. The TFR-A's bridge tilts at a 45° for full length angle cuts. The head of the saw doesn't tilt but the entire beam system will tilt. The advantage to this is there are no bearings or moving parts on the bridge of the saw or the motor that can loosen to negatively impact exact miter cutting. The entire bridge will easily rotate using two knobs that you loosen to make adjustments to the angle. Standard features:

- Manual feed head with variable speed in both directions so the operator has control
- Motor: 7 Hp and 3,400 RPM
- Worktable is made of galvanized steel rails with powder finish for durability in all conditions
- Cutting Depth Adjustment – Another manual feature is the cutting depth adjustment
- Manual bridge tilts 90° to 45° for precise cutting
- Useful cut length: 10' 8"
- Equipped with no. 6 worktable extensions and side stop



Parallel Cutting Device Accessory

Stock No.	Description	Price
055614	TFR-A Bridge Saw	\$23,856.95

Stock No.	Description	Price
053305	Laser for TFR-A/TFM Saws.....	\$1,213.95
053306	Parallel Cutting Device.....	3,128.00
053304	Side Extension Table, No Rollers.....	1,322.95
053303	Side Extension Table, With Rollers.....	1,296.95



Achilli® TSA Portable Rail Saw

The TSA Rail Saw is Achilli's cost effective way to cut large slabs. The rails are placed directly on the stone slab for cutting. Standard and optional features:

- Head travels on 6 bearings 1 1/4" in diameter
- Frame made of steel, painted with epoxy-powder finish to withstand the harshest shop conditions
- Two extension Tables: 31.5" X 23" and a side stop, allowing the option of adding more tables
- Manual cutting depth adjustment by hand wheel
- Rails available in multiple sizes from 4' - 13' and may be configured with adjustable feet for additional stability
- Easy, one-handed water disconnect

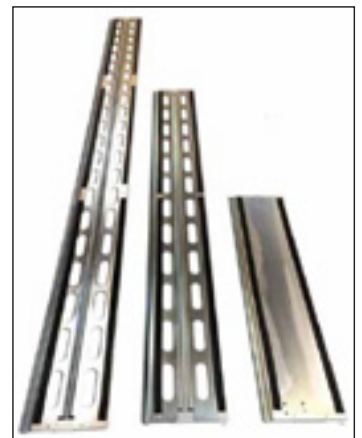

Optional Rails, 4', 8' and 13' Lengths

Stock No.	Description	Price
053311	Achilli TSA Saw, No Rails	\$2,830.95
053312	Achilli TSA Saw With Rails.....	3,466.95
053313	Achilli 4' Rail for TSA Saw	199.95
053314	Achilli 8' Rail for TSA Saw	399.95
053315	Achilli 13' Rail for TSA Saw.....	551.95

SPECIALTY POWER TOOLS

Flute Grinding & Polishing System

Precisely fabricate fluting for drain boards, fireplace surrounds and other decorative marble and granite pieces without improvisation! Professionally grind and polish flutes without the tedious handwork normally required.

The system includes a 10" diameter diamond wheel which grinds fluting into granite and marble. Included: a unique, water-fed pneumatic grinder and a specially formulated series of resin bonded polishing wheels. To finish the job: a pre-shaped felt wheel and polishing compounds for marble and granite.

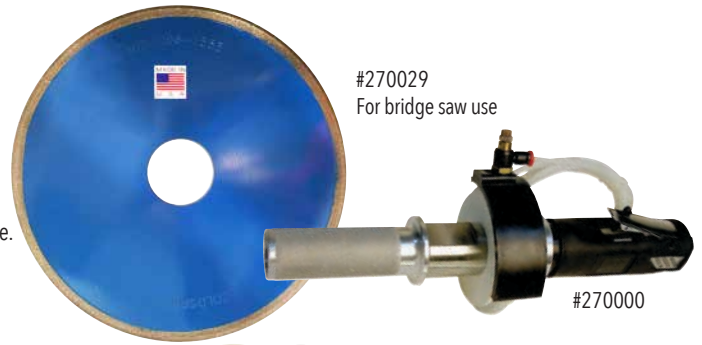

#270029
For bridge saw use

#270000

Stock No.	Description	Grit	Price
270029	*300mm O.D. x 12.7mm x 60mm arbor Plated Fluting Wheel for Bridge Saw use	60/85	\$555.00
270000	Pneumatic Flute Polishing Machine, BPMF 100		410.00
270004	1/2 Liter Marble Polish BMP 112		38.92
270005	1/2 Liter Granite Polish BMP 115.....		40.43
270007	Spanner Wrench #1 BMP 201.....		9.83
270008	Spanner Wrench #2 BMP 201.....		9.97
270019	Electroplated fluting Wheel	100.....	104.95
270022	Resin Fluting Wheel.....	200.....	91.30
270023	Resin Fluting Wheel.....	400.....	91.30
270024	Resin Fluting Wheel.....	800.....	91.30
270025	Resin Fluting Wheel.....	1500.....	91.30
270026	Resin Fluting Wheel.....	3000.....	91.30
270027	Resin Fluting Wheel.....	Buff.....	94.45
270020	Fluting Felt Wheel 100 x 12.7 x 22mm.....		73.45

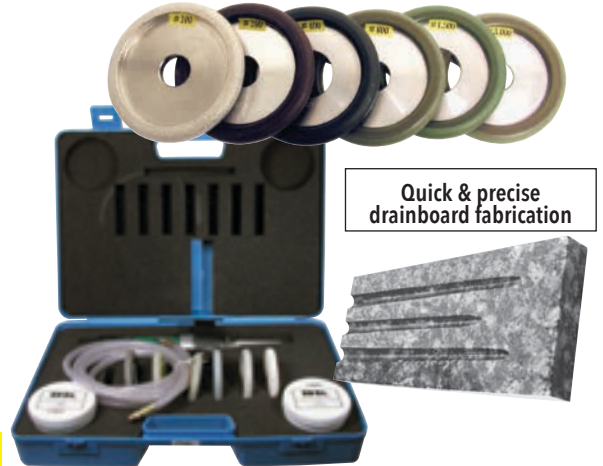

Quick & precise
drainboard fabrication

***#270029 for Bridge Saw applications only.**



Jet Stik Stone Flaming/ Texturing Tool

Propane powered, water cooled rocket engine that produces exhaust gases exceeding 5,300°F. The Jet Stik includes hoses and a propane regulator. Use for carving, quarrying, texturing, and cleaning dimensional stone and surfaces.

Stock No.	Description	Price
109400	Jet Stik 27" Flaming Tool Kit.....	\$2,199.99
109401	Jet Stik 48" Flaming Tool Kit.....	2,369.99
109402	Jet Stik Oxygen Regulator.....	108.86

**GranQuartz®
BIG DOG™ Stone Chiseler
and Carbide Teeth Sets**

- Powerful air over hydraulic ergonomic design
- 2cm to 8cm capacity
- Includes pump and 3 sets of quick change mining grade carbide teeth for multiple edge designs



Stock No.	Description	Price
721831	BigDog + 3 Sets of Straight Teeth.....	\$3,360.00
790207	BigDog + Sets of Teeth, 2-8 CM Capacity.....	3,785.00
790214	Reverse Scallop Teeth Set.....	418.00
600106	Narrow Teeth Set for HD Stone.....	143.00
600105	Soft Stone Teeth Set.....	176.00
600104	Laminated Stone Teeth Set.....	176.00
944481	Scallop Teeth Set.....	473.00

**The Beaver
Stone Chisel**

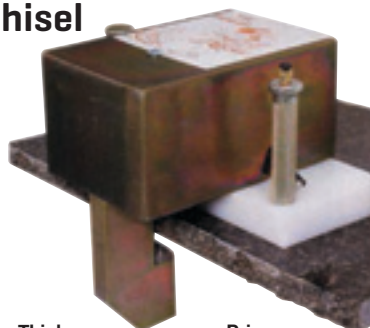

Stock No.	Stone Thickness	Price
500113	3/4" up to 1-5/8"	\$1,919.00
500114	3/4" up to 2-3/4"	2,795.00

**Rockbiter
Stone Chiseling Tool**

Create a split face chiseled edge on natural stone. Faster and easier to use for increased profit and productivity. Safer edge production than similar tools, without harsh impacts.

Stock No.	Stone Thickness	Price
800005	2-4 cm stone	\$775.00
696412	6 cm stone	1,035.00
699322	3-6 cm stone	1,145.00

Pair of steel replacement teeth
800007

Pair of steel replacement teeth w/tungsten carbide inserts
800009



Magnum® Router Elite Series

Magnum Elite Series 2018 Upgrades (Magnum 3 & 5)

Featuring a fan-less motor, fully shielded cover and pre-loaded bearings for a more quiet machine. The first 5 feet of the power cord coming from the router is wrapped with a nylon braided sheath to help protect against damage caused by sharp stone edges, dropped tools and other shop or job site hazards. Includes ample loc-line to enable the user to run water from any angle.

- Powder coated stainless steel wrap-around handle prohibits rust
- Higher grade steel spindle shaft and motor pulley ensures part longevity
- Packaged in an impact-resistant, lockable plastic tool box with wheels

Magnum Elite Series Upgrades (Magnum3 only)

- The individual start/stop and E-stop switches have been upgraded to a power on/off tactile membrane switch, rated to last 10,000 cycles, vastly outperforming the original buttons
- LED indicator lights when the router is powered up and for when it is running

Magnum Elite Series Upgrades (Magnum 5 only)

- The variable speed drive is now located inside the router along with all other electrical components; no more bulky electrical cabinet needed to run the Magnum 5, making it the EXACT SAME PHYSICAL SIZE AS THE MAGNUM 3
- With the VFD now located inside the cutting unit, there is a different approach we've taken to ensure personnel safety; a detachable (single phase 20A 280/220VAC) GFCI (Three phase 30A 220VAC available and sold separately)
- The Magnum 5 Elite Series router has a similar tactile membrane switch to the Magnum 3 Elite Series, but with the added benefit of a speed increase and a speed decrease button
- Magnum 5 still has a speed threshold of 2400-9500 RPM
- Tough water-resistant tachometer with large, bright display



Model	MAGNUM 3/single speed	MAGNUM 5/variable speed
Speed/RPM	8,500	2,400-9,500
Torque	4.8 ft.-lbs.	6 ft.-lbs.
Horsepower	1.5	3
Power requirements	single phase/120V/20 AMP	single phase/208/220V, 20 AMP
Tachometer	No	Yes
On/Off switch	Yes	Yes
Speed control switch	No	Yes
Warranty	90 days electrical, 6 mos. mechanical	90 days electrical, 6 mos. mechanical

IMPORTANT:
Magnum 5 Router requires a 20 Amp breaker, (Magnum 3 requires 15 Amp breaker) extension cords MUST BE 10 gauge or heavier

Stock No.	Description	Price
300354	Magnum 3 Elite Single Speed Router with Hydroplate	\$2,882.25
300355	Magnum 5 Elite Variable Speed Router with Hydroplate	\$4,635.00

The Magnum 5 is the stone industry's FASTEST, most POWERFUL router, with 6ft.-lbs. of torque!

Router Cart

- 36 3/4" L, 17 1/4" W, 34" Tall
- Solid rubber casters, 2 w/locking brakes

Stock No.	Description	Price
300300	Router Cart.....	\$99.00



Magnum® Hydroplate

- Glides routers smoothly over the work surface on a blanket of water.
- For Magnum 3 or Magnum 5

Stock No.	Description	Price
300166	Hydroplate.....	\$556.35

MASTER 3500 ROUTER



Master 3500 Router

The MASTER 3500 from Marmoelettromeccanica is designed for fabrication of marble, engineered stone and granite. The router is engineered using an electrical supply which is very low tension for safety reasons and is supplied via the use of an electrical conversion unit. The Master 3500's water system includes a "hydro" base which creates a gliding film of water between the machine and the slab, eliminating the stone pieces being damaged, broken or scratched during the fabrication process. The Master 3500 machine is built with high-quality material and designed to last for years of service.

Features:

- Versatile when working with different kinds of profiles
- Safe to use and easy to learn
- Easy to transport
- Heavy duty design withstands the harshest shop environments

Stock No.	Description	Price
442331	Master 3500 Router with Gliding Base.....	\$4,449.00
442409	MARMOELETTRMECCANICA 3,000 Watt Transformer	\$851.00

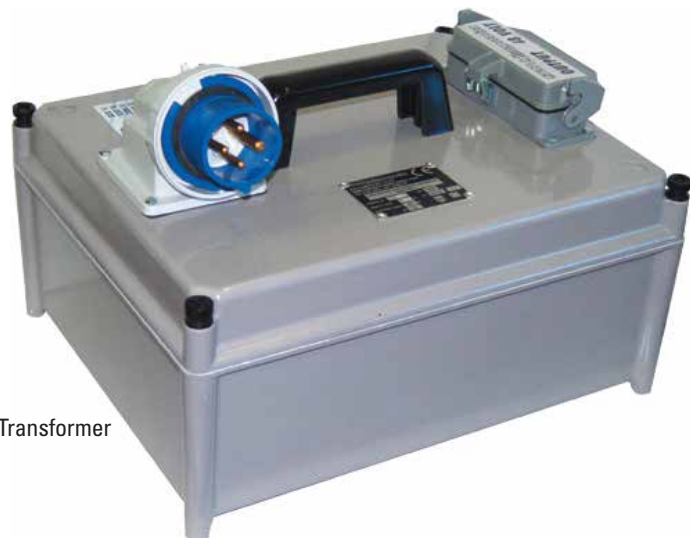

#442409 Voltage Transformer

EDGE MILLING AND POLISHING

Klindex UFO 330 Planetary Polisher

The Klindex UFO 330 is a unique solution to producing planetary polishing results with a small tool investment. The UFO 330 uses the proven technology of a full-scale floor machine but in a much smaller package.

The Klindex UFO 330 features a large, 1 horse power motor that is centered over the grinding head making the 36 lbs. machine superior in creating an even surface.

- 13" working width
- 1 hp motor power
- 1-phase
- 110 or 220V, 10 Amp
- 1,000 RPM
- Weight: 36 lbs.
- Includes 3, 5" Aluminum backers
- Tank capacity: 2 Liters
- Made in Italy



Stock No.	Description	Price
993131	Variable Speed, 330-770 RPM	\$4,140.00



Aqua Router

- Runs off a 3.25 hp Makita® platform
- Uses standard "Sector" 7/8" connection router bits
- Powerful 15 AMP/10,000 - 22,000 RPM motor
- Must be used with a GFCI
- 110V
- 2 LED lights aid when light conditions are low
- 3 Safety locks when adjusting height
- New model is lighter, helping to reduce friction between router base and stone surfaces

Stock No.	Price
790021	\$1,649.00



3-Head Planetary Polisher Model DS 3011

A rugged planetary tool designed to produce a flat, swirl free finish on counter tops, floors, wall, and steps. The DS 3011 can utilize a variety of abrasive products to fit many different applications including grinding, polishing, and texturing natural stone, terrazzo, and concrete.

- Power: 115 Volt / 11 Amp
- Drive Speed: 2,500RPM
- Platen Speed: 405 RPM
- Includes 3, 5" Aluminum backers
- Tool Weight: 30 lbs., Shipping Weight: 37 lbs.

Stock No.	Price
117752	\$2,600.00

T-31 ANCHOR MACHINES & ACCESSORIES

OmniCubed ProAnchor™ T-31 Anchor Machines

The Pro-Anchor easily and precisely cuts T-slots in stone for bottom-mount sinks and architectural facings. Featuring precision alignment indicators and a unique split-clamp design for optimum accuracy and stability. Electric or pneumatic models available, each with an optional vacuum base.

- Uses 1/4" shaft anchor bits

Stock No.	Description	Price
350280	Elec.w/vacuum (PA-132-EV).....	\$995.00
350281	Elec.no vacuum (PA-132-E)	850.00
350282	Pneum.w/vacuum (PA-132-PV).....	795.00
350283	Pneum.no/vacuum (PA-132-P).....	650.00



#350280



#350280

Made in the USA from US & imported parts.

T-31 Electric Anchor Machines

Electric version of the popular T-31 anchor machine, available with or without vacuum plate.

- 110V
- Make multiple sized mounting slots in any stone surface
- Warranty: 1 year



Stock No.	Description	Price
933198	Electric, no vacuum plate.....	\$1,109.00
933199	Electric with vacuum plate.....	1,165.00

T-31 Pneumatic Anchor Machine

Only available with vacuum base. Three bit sizes for anchoring to a wider range of stone thicknesses. Cuts in either PUSH or PULL direction. 8 HP motor w/ three bearing design. Powder coated body with corrosion-resistant pivots.

- Air requirements: 90 PSI @ 18–20 CFM
- Multiple sized slots in any stone
- Warranty: 1 year

Includes wrenches, case and one 3/16" Diamond Cutting Bit!



Stock No.	Description	Price
933200	Pneumatic T-31	\$1,029.00

Pro Series® Vacuum Brazed Anchor Bits

- Fast cutting action • Either 3/8" or 1/4" shank.
- Vacuum brazed for long life

Size	3/8" Shank	Price	1/4" Shank	Price
3/16"	933301.....	\$21.95	933309	\$26.20
1/4"	933303.....	27.25	933310	29.35
3/8"	933305.....	30.40		



NEW!

Center Water Fed T-31 Bits!



Electroplated T-31 Anchor Bits

- Available with 3/8" or 1/4" shank.

Size	3/8" Shank	Price	1/4" Shank	Price
3/16"	933306.....	\$26.19	933018	\$31.28
1/4"	933299.....	34.13	933307	39.78
3/8"	933302.....	49.95		
T-31 Bits w/Center Water Feed				
3/16"	364298.....	49.95		

T-Anchors with Nuts, Washers, Lock Washers

- Sold in packs of 25 (sets)

Stock No.	Description	Price
933313	3/16" x 1 1/2"	\$20.51
933314	3/16" x 2"	22.33
933315	3/16" x 2 1/2"	23.59
933316	1/4" x 1 1/4"	22.59
933317	1/4" x 1 1/2"	23.59
933318	1/4" x 1 3/4"	23.59
933319	1/4" x 2"	25.07



T-31 Anchors are intended ONLY for mounting undermount sinks to countertops.

Stock No.	Description	Price
933320	1/4" x 2 1/2"	\$31.45
933321	1/4" x 3"	34.14
933322	1/4" x 4"	45.54
933323	3/8" x 2"	46.68
933324	3/8" x 2 1/2"	45.89
933325	3/8" x 3"	61.50
933326	3/8" x 4"	70.11

Sink Clips

- Pack of 25

Stock No.	Price
933327	\$46.65

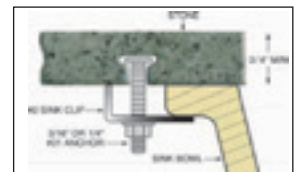
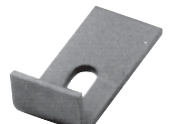



Lighted Plug Ends

Conntek Lighted Power Cords

Heavy duty power cords & GFCIs with power indicator lights at plug.

- Heavy duty contractor grade
- Lighted ends
- Available in 25' or 50' (cords)
- Available in 12 or 10 Volt/15Amp

Stock No.	Description	Price
202512	12/3, 25' Cord	\$35.75
202515	12/3, 50' Cord	49.95
202511	12/3, 100' Cord	89.99
209103	3-Outlet GFCI	42.40



Grinder Caddy

Will Fit the Following Grinders:

- Dewalt® DW402 • Rigid®R1000
- Makita® 9527PB • Bosch®1710 • Hitachi®G125E2 • Milwaukee®6148-6

Stock No.	Price
693708	\$41.55



For Angle Grinders

- Installs in seconds
- Easy to Use
- Great for tuck pointing
- Non-marking wheels
- Adjustable depth of cut

Water Kit™ for Wet Cutting Applications

CONTROLS DUST & INCREASES TOOL LIFE!

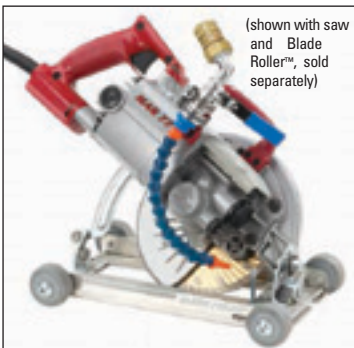

(shown with saw and Blade Roller™, sold separately)



GFCI INCLUDED

- Reduces the operator's exposure to dangerous airborne pathogens, dust and fatigue.
- Extends the life of your blade by up to 50%.

Water Kit™ 693720.....	\$109.89
---------------------------	----------



Pearl® Vacu-Guard™ Attachment

Work cleaner, faster and healthier using Pearl's new dust containment attachment.

- Fits Flex L1109K & L1506VR Saws

Stock No.	Desc.	Price
340299	Vacu-Guard.....	\$169.95

PEARL.



Pneumatic Tool Lubricant

16 oz. bottle, formulated to ISO 46 standards: inhibits rust, non-corrosive

Stock No.	Desc.	Price
600670.....	16 Oz. Bottle	\$9.49

Loc-Line Flexible Water/Coolant Line

- End nozzles, Y fittings and ON/OFF valves let you custom design your coolant feed system



Stock No.	Description	Price
117981	1/4" diameter x 1 ft. length Water Hose.....	\$7.74
117982	1/8" diameter Round Outlet Nozzle	1.25
117983	1/4" diameter Y Fitting.....	3.67
117984	1" wide Flare Outlet Nozzle.....	3.67
117985	1/4" In-line ON/OFF Valve	7.19
117986	1/4" In-line ON/OFF Valve w/1/2" NPT male thread	7.19
117987	Loc-Line Assembly PLIERS	17.27
117988	1/4" NPT Loc-Line Connector.....	1.65

PEARL BLADE ROLLER

For Circular Saws

- No Tools required • Non-marking wheels
- Eliminate costly heavy equipment



The Original 693710.....	\$62.35
-----------------------------	---------

- FOR: Skil® HD77, HD77 MAG
 • Skil® HD5860 (8-1/4" saw) • Makita® 5447NB
 • Bosch 1677M

Side Winder™ 118282.....	\$62.35
-----------------------------	---------

- FOR LEFT AND RIGHT SAWS INCLUDING:
 Makita® 5007NH • Makita® 5007NL • Makita® 5007NB • Dewalt® DW368 • Porter Cable® 743 • Milwaukee® 6390 • Bosch™ 1655

Anchor Continental Monument Stencil Material

#111 (1.1 mm) easy release. Single back stencil designed for hand cutting. Superior for shape carving and easy cutting.

Stock No.	Description
365042	H, 12 3/4" W, 2-Roll Pack
365043	H, 18 3/4" Width
365044	H, 21" Width
365045	H, 25" Width
365046	H, 30 1/2" Width

#116 (.8 mm) Single back stencil. High tack adhesive formulated to adhere to raw wood and rough surfaces without using filler. For use with Gerber plotters.

Stock No.	Description
365047	TFS, 15" Width, High Tack
365048	FS, 30" Width, High Tack

#117 (.8 mm) Single back stencil. Suitable for use on monuments, wood or glass. For Gerber plotters.

Stock No.	Description
365049	TFS, 15" Width, High Tack
365050	FS, 30" Width, High Tack

#123 (1.2 mm) Double back mylar stencil. Designed for machine cutting. Excellent blast resistance.

Stock No.	Description
365052	M, 12 3/4" W., 2-Roll Pack
365053	M, 15" Width
365054	M, 18 3/4" Width
365055	M, 25" Width
365056	M, 30" Width

#124 (1.2 mm) Double back mylar stencil. Designed for cutting on Gerber plotters.

Stock No.	Description
365057	S, 15" Width
365058	S, 30" Width

#125 (.9 mm) Signblast stencil. High tack adhesive formulated to adhere to raw wood and rough surfaces without using filler.

Stock No.	Description
365062	H, 25" Width, High Tack

#129 (1.2 mm) Yellow mylar stencil with a thick mylar liner for sprocket holes. 15" suitable for use on Gerber and IBM style sprockets. 30" suitable for IBM sprocket only.

Stock No.	Description
365064	SF, 15" Width, Yellow
365065	TF, 25" Width, Yellow
365068	TF, 30" Width, Yellow

#153 (.8 mm) single back stencil. This unpunched product is designed for the Roland friction feed plotter.

Stock No.	Description
365069	F, 19 7/8" Width
365070	F, 24" Width

#154 (1.2mm) double back mylar stencil. Features the same construction as #123 machine stencil. Designed to be used with IBM sprocket plotters only.

Stock No.	Description
365071	T, 15" Width
365072	T, 18 3/4" Width
365073	T, 25" Width
365075	T, 30" Width

#155 (.8 mm) Same construction as #153 stencil, except this product has a water-based acrylic adhesive, rather than petroleum based.

Stock No.	Description
365077	F, 19 7/8" Width
365078	F, 24" Width

#156 (.8 mm) Same construction as our high-tack #116 computer stencil, except that the hole pattern is for use on standard 1/2" center machines.

Stock No.	Description
365079	TF, 30" Width, High Tack

#157 (.8 mm) single back stencil. Same construction as #111 regular stencil. Designed to be used with IBM sprocket plotters only.

Stock No.	Description
365080	TF, 30" Width, Medium Tack

#192 (1.1 mm) yellow mylar stencil with Gerber punch. Same as the #124 except features a thicker, clear liner.

Size	Item#	
10"	5502-19230004	S
30"	5502-19230004	S



Legend:

Y	Yellow inner liner	H	Hand Cut
T	IBM computer hole plotter	F	Friction Fed
S	Gerber computer hole plotter	M	Machine
P	Polyester		
YP2	All rubber is rolled out		

#T226 (.5 mm) High-tack BlastLite™ is a specially-formulated rubber mask that is long-lasting and easy to use. Natural flexibility properties and impact resistance is great for shallow blasting.

Stock No.	Description
365082	H, 25" Width, High Tack Blastlite
367733	H, 30" Width, High Tack Blastlite



Call Us For
Everything You Need for
Monument Work.

Legend:	
Y Yellow inner liner	H Hand Cut
T IBM computer hole plotter	F Friction Fed
S Gerber computer hole plotter	M Machine
P Polyester	
YP2 All rubber is rolled out	

3M™ Scotch Monument Stencil

3M Sandblast Stencil 519YP2T

47.0 mil (1.2 mm) tan rubber backing with clear film laminate, rubber adhesive and 2mm thick translucent white film liner. Computer-Cut, Tractor Feed - Double Liner Format. 1/2" on center punch.

Stock No.	Description
365118	T, 25" Width x 10 Yards
365121	T, 25" Width x 20 Yards
365128	T, 30" Width x 10 Yards
367736	T, 30" Width x 20 Yards

3M Sandblast Stencil 519YT

45.0 mil (1.1 mm) tan rubber backing with clear film laminate, rubber adhesive and easy-release translucent white film liner. Computer-Cut, Tractor Feed - Double Liner Format. 1/2" on center punch.

Stock No.	Description
365109	T, 15" Width x 10 Yards
365113	T, 18 3/4" Width x 10 Yards
365117	T, 25" Width x 10 Yards
365120	T, 25" Width x 20 Yards
365124	T, 30" Width x 10 Yards

3M Sandblast Stencil 519YS

45.0 mil (1.1 mm) tan rubber backing with clear film laminate, rubber adhesive and easy-release translucent white film liner. Computer-Cut, Slot Punched - Double Liner Format.

Stock No.	Description
365110	S, 15" Width x 10 Yards
365126	S 30" Width x 10 Yards
365132	S, 30" Width x 20 Yards

3M Sandblast Stencil 520T

45.0 mil (1.1 mm) tan rubber backing with gray rubber adhesive and easy-release clear film liner. Computer-Cut, Tractor Feed - Single Liner Format. 1/2" on center punch.

Stock No.	Description
365138	T, 15" Width x 10 Yards
365142	T 25" Width x 10 Yards
365145	T, 30" Width x 10 Yards

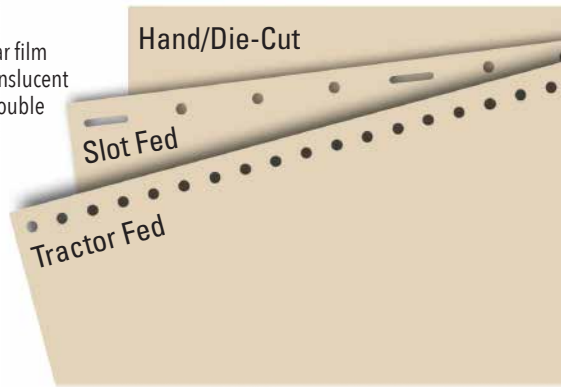

3M Sandblast Stencil 1532S

37.0 mil (.9 mm) green rubber backing with rubber adhesive and dark green polyethylene film high release liner. Computer-Cut, Slot Punched - Single Liner Format.

Stock No.	Description
365099	S, 30" Width x 10 Yards

3M Sandblast Stencil 520S

45.0 mil (1.1 mm) tan rubber backing with gray rubber adhesive and easy-release clear film liner. Computer-Cut, Slot Punched - Single Liner Format.

Stock No.	Description
365137	S, 15" Width x 10 Yards
365144	S 30" Width x 10 Yards

3M™ Stencil

3M Sandblast Stencil 507

43.0 mil (1 mm) green rubber backing with rubber adhesive and dark green polyethylene film high release liner. Ideal for letter press operations. Hand-Cut - Single Liner Format.

Stock No.	Description
365101	FH, 12 1/4" Width x 10 Yards
365102	T, 24 1/2" Width x 10 Yards

3M Sandblast Stencil 510

442.0 mil (1 mm) green rubber backing with rubber adhesive and easy-release clear film liner. Hand-Cut - Single Liner Format.

Stock No.	Description
365103	H, 12 3/4" Width x 10 Yards
365104	H, 18 3/4" Width x 10 Yards
365105	H, 25" Width x 10 Yards
365106	H, 30" Width x 10 Yards

3M Sandblast Stencil 519Y

45.0 mil (1.1 mm) tan rubber backing with clear film laminate, rubber adhesive and easy-release translucent white liner. Die-Cut, Doubled Liner Format.

Stock No.	Description
365107	FHM, 12 3/4" Width x 10 Yards
365108	FHM, 15" Width x 10 Yards
365112	FHM, 18 3/4" Width x 10 Yards
365116	FHM, 25" Width x 10 Yards
365123	FHM, 30" Width x 10 Yards

3M Sandblast Stencil 520

45.0 mil (1.1 mm) tan rubber backing with gray rubber adhesive & easy-release clear film liner. Hand and Die-Cut - Single Liner Format.

Stock No.	Description
365136	FH, 15" Width x 10 Yards
365139	FH, 18 3/4" x 10 Yards
365141	FH, 25" Width x 10 Yards
365143	FH, 30" Width x 10 Yards

For over 100 years, GCT is THE full line supplier of sandblast equipment, abrasive, adhesives, handling equipment and more.



Flatbed Stencil Cutter 827 & ANAfeed Flatbed Stencil Cutter

Works with any stencil - saves money by using non-punched stencil and scrap pieces. Stencil is held in place by vacuum.



#362693
Flatbed Plotter

Developed for monument professionals to provide reliability, high quality cutting and cost Savings!

Blades

Stock No.	Type
990080009.....	45°
365417	60°

Black Pen

#362805



#362804
Flatbed Plotter
with Automatic Feed

BENEFITS OF FLATBED DESIGN:

- Stop paying extra to have perforations punched into your stencils
- Cut the full Width of your material
- Cut scrap pieces for dates & small stencils
- Nest Monuments for better Stencil use
- No sprockets to get out of adjustment
- No thick and thin lines
- Material is vacuumed down and not moving
- Accurate cutting of even the smallest details
- Will run using all monument software
- Convenient tool holder
- Round knife cut off for Stencil

Plotters	Cutting Speed: 33 .5 in/sec
Cutting Area: 30.78"x60"	Maximum material width: 33"
Power Input: amp@115vac amp@230	Warranty: 1 year limited extended warranty available
Configuration: Closed loop digital Servo system	Software Language Driver: compatible with all graphics software using HPGL format Custom sizes available



Norton Stoneblast Abrasives

A hard, durable premium aluminum zirconium oxide abrasive compound. Excellent for monumental sandblast lettering, industrial and general sandblasting.

- 50 lbs. per box
- Long lasting 36/60 grit particles

Stock No.	Size
358519	50 Lbs.



#358515
50 Lb. Bag

The perfect blend for all of your sand-blasting medium needs. Zirconia alumina is a mixture of zirconium oxide and aluminum oxide.



#358501

Econoblast Aluminum Oxide

ECONOBLAST is an economical, safe and "silica free" abrasive made of pure white aluminum oxide abrasive, and graded in a 60/80 grit blend. Ideal for cemetery lettering ECONOBLAST is proven to be the most cost effective blasting abrasive.

- 50 lbs. per box



Steel Shot

Use steel shot on granite for greater contrast and whiter panels. Great for delicate shape carving, especially for fine detail and the whitest natural panels. Size No. S-170 is preferred by many for this dual purpose.

- 50 lbs. per bag

Stock No.	Grit
358517	S-170
358518	S-230



Sintered Bauxite Ball

This is a very durable long lasting material that lasts 2 to 3 times longer than aluminum oxide and is much more economical. It is not affected by surrounding humidity, contains no free-silica, and will not rust.

- 50 lbs. per bag

Stock No.	Grit
358516	20-40



Dynablast Abrasive

Pure Aluminum Oxide premium blasting abrasive. Coarse grits are used in monumental sandblast lettering, industrial blasting, steel blasting and cleaning. Fine grits are used in monumental shape carving and general sandblasting when smooth surface textures are needed. Available in 50 lbs. Bags.

Stock No.	Grit	Stock No.	Grit
358506	30	358509	80
358507	36	358510	120
358508	60	358511	180

Double Line Nylon Slings - Pairs

Few fibers have the strength of nylon. This soft, flexible material is only 5/32" in thickness. Can be made into slings of any length. Nylon is resistant to grease, oil, mildew, rotting and aging.

Other sizes and plys available

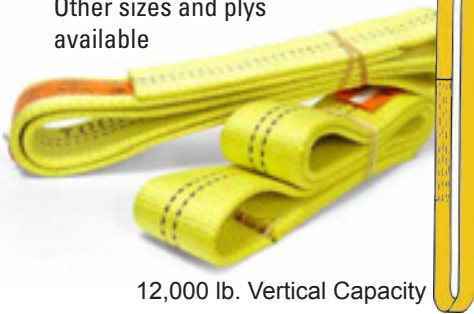

Size	1 PLY
3" x 3' 6"	364953
3" x 4'	364955
3" x 4' 6"	364957
3" x 5'	364959
3" x 5' 6"	364961
3" x 6'	364963
3" x 7'	364964
3" x 8'	364967

12,000 lb. Vertical Capacity

Twintex Nylon Endless Stone Slings - Pairs

Rugged slings designed expressly for lifting stone, building panels, and many other rough surfaced materials. Made of woven nylon web reinforced with special surface gripping and abrasion resistant facing yarns. 8,000 lb. vertical lift cap. Available in 4" width only.



Size	1 PLY
4" x 3' 6"	364944
4" x 4'	364965
4" x 4' 6"	364966
4" x 5'	364970
4" x 5' 6"	364985
4" x 6'	364971
4" x 7'	364972
4" x 8'	364973

8,000 lb. Vertical Capacity

Crate Sling - Pairs



3,200 lb. Vertical Capacity

Light weight, easy to handle nylon sling designed to handle crated stone products. Available in single or 2-ply endless construction.

Size	1 PLY
1" x 3'	364945
1" x 4'	364947
1" x 5'	364948
1" x 6'	364949
1" x 12'	364952

Eye-to-Eye Choker Slings - Each

Eye-to-Eye Choker Slings the answer to all your web sling lifting and or pulling applications. Used to lift markers, slants, bases and dies in a hurry. Slip one end underneath stone and come up through the eye on other end, tighten. Then put open eye on hook of your hoist.



Twist Eye		Flat Eye	
Size	2 PLY	Size	2 PLY
2" x 8'	364992	2" x 8'	364981
2" x 6'	365000	2" x 10'	364960
2" x 12'	364993	2" x 12'	364982
		2" x 16'	364969

6,400 lb. Vertical Capacity



Bundle Sling, 2 ply - Each

11,500 lb. Vertical Capacity



Size	Item #
4" x 18' Eye to Eye	365007
6" x 3' Sleeve	365008

Tulflex Round Slings - Each

Endless in configuration, and are constructed from endless yarns of 100% polyester fiber encased in a tough polyester woven tube.

Tulflex are superior in their ability to conform to the shape of the load and may be used in all three types of hitches. Specify desired capacity and length.



Size	Item #
6'	364958
3'	364976
10'	369130

Type-B Rollers and Shackles #1722

The type "B" Rollers and Shackles are designed for heavy-duty lifting. The maximum load is 4 tons. Use with endless stone slings up to 4-1/2" width.



15"

364939



2,000 lb. cap.

Straight Bar Type Shackle

The Straight Bar Shackle is built for use where headroom is low. Slings are suspended within 4" of the hoist hook for maximum use of headroom. Depending upon the size of the load, slings may be suspended from 11", 20" or 29" centers. Well constructed and balanced. Available in short bar type, 24" length with two place settings. Standard type, 34" length with three place settings. 4" rollers.

BAR 24"	BAR 34"
3649301	364932

St. Cloud Type Rollers and Shackles

These rollers and shackles are used where headroom is a problem. Slings are suspended from

aluminum rollers just 10" below the load hook to save space. Rollers are plain with a slight crown in the center and roll independently of the close fitting flanges. Rollers take slings up to 4" width. This assembly is handy in all plants and on truck cranes where lifting height is limited.



Size	Item #
14"	364933
18"	364935
24"	364937

2,000 lb. cap.

Type-A Rollers and Shackles

Most popular of all hardware for handling endless slings. The A-shaped yoke is designed to give equal and sufficient spread, allowing balanced suspension and freedom of movement of the load at all angles. Slings are suspended on crowned aluminum rollers, which roll independently of the close fitting flanges. This makes turning of the load in the sling easier. Rollers will handle up to 4" wide slings.

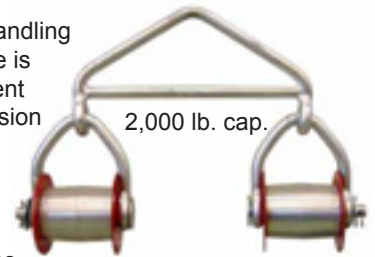

2,000 lb. cap.

14"	364934
18"	364936
24"	364938



Spreader Lifting Beam

Adjustable lifting points
Handle both wide and unbalanced loads
Optional: Swivel hooks and shackles

Specifications
Working Load Limit (WLL): 2.5 Tons
Weight: 92.6 lbs

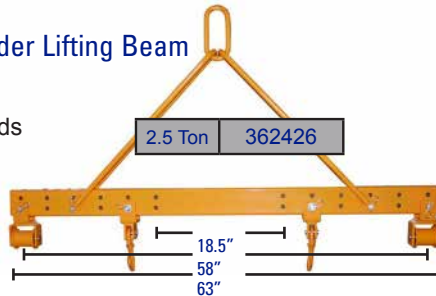

2.5 Ton 362426

18.5"
58"
63"

Specifically designed for the stone industry. The spreader bar, in combination with endless slings, is an invaluable piece of equipment where stone is required to be rolled over. Slings are suspended on crowned aluminium rollers. This makes turning of the load in the sling easier. Rollers will handle up to 100mm wide slings. Swivel hooks can be used in place of rollers. Overall width 2000mm.

Pin Lewis (sold in pairs)

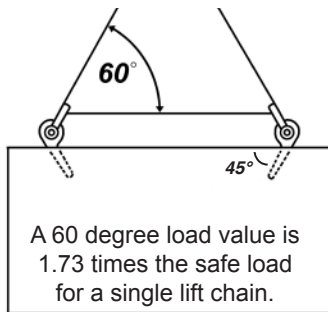

Pin Dia.	Pin Length	Pin Cap.	Size Alloy Chain	Item #
1/2"	3-1/2"	3/8 ton	1/4"	2518-0014
5/8"	4"	3/4 ton	1/4"	2518-0008
3/4"	4-1/2"	1-1/2 ton	1/4"	2518-0009
7/8"	5"	3 ton	3/8"	2518-0004
1"	6"	4-1/2 ton	3/8"	2518-0010
1-1/4"	6-1/4"	4-1/2 ton	3/8"	2518-0017
1-1/8"	6-1/2"	6 ton	1/2"	2518-0005
1-1/4"	7"	9 ton	1/2"	2518-0015
1-1/2"	6-3/4"	9 ton	1/2"	2518-0019
1-1/2"	7"	12 ton	5/8"	2518-0007
2"	9"	20 ton	7/8"	2518-0016



H.D. Straight Bar Type Shackle



Heavy Duty

35" Swing Bar w/Pipe Roller & Washers
From 1 - 4 Ton Capacity
Use up to 4in Slings

35" 365034

Join-Tite Setting Compound

The most popular setting compound in the industry.



Color	Gallon
Light Grey	364767
Dark Grey	364768
Brown	364769



4 Cartridge	364663
6 Cartridge	364664

GCT Dust Collectors

- Cartridge style downward flow dust collector
- 4 cartridge filters for up to 1,016 sq ft of filter media
- 6 cartridge filters for up to 1,524 sq ft of filter media
- 8 cartridge filters for up to 2,032 sq ft of filter media
- Nano fiber elite, merv 15 filters
- 5 HP motor/blower rated for 2,000 CFM @ 10" (4 Cart.), 4,500+ CFM (6 Cart.) 6,000+ CFM (8 Cart.)
- Reverse pulse filter cleaning system
- Filters are 99.9% efficient
- Dwyer pulse control timer board with built-in digital pressure gage
- Drum lid with latch kit
- Quick-lock, easy-access filter doors
- 5 year material and craftsmanship warranty
- Goyen solenoids and diaphragms
- **Made In the USA**

Terms And Conditions

Credit Policy

To qualify for open account status, a credit application must be completed in full. Satisfactory references are required. Those approved for open account are notified by mail. Companies not qualifying for open account are either C.O.D. or cash with order. The amount of credit we extend to a customer is subject to change or limitation at any time, either before or after the delivery or any part thereof of an order. Payment in cash may be required as a precedent to delivery. If a customer account is in arrears, we shall have the right, in addition to all other legal remedies, and without prejudice to any other of our rights, to defer further deliveries until full payment is received.

Receipt of payment, whether full or partial, shall in no way obligate us to extend further credit. In case the business of a customer is sold or transferred, or a customer becomes insolvent, or is sued by any creditor, or by customer, or a receiver is appointed for the customer or the customer's business, then in each such event the total amount shall be at once due and payable without notice or demand of any kind. Should a customer's check be returned by the bank, there will be a returned check charge, which is currently \$50. This fee is subject to change without notice.

Statement of Liability

The following statement is made in lieu of all warranties, expressed or implied; GranQuartz and/or manufacturer's only obligation shall be to replace such quantity of product proven to be defective provided that such guarantees or replacement are a stated policy of the manufacturer.

GranQuartz and/or manufacturer shall not be liable for any injury, loss or damage, direct, incidental or consequential, arising out of the use or the inability to use the product. Before using, user shall determine the suitability of the product for its intended use, and user assumes all risk and liability whatsoever in connection herewith. The foregoing may not be altered except by officers of GranQuartz.

Shipping Policy

Unless otherwise stipulated, goods covered within an order shall be shipped "FOB origin". Title to said goods pass to Buyer upon departure from the shipping point, regardless of risk of loss. Transportation charges on goods delivered FOB origin must be paid in accordance to customer terms noted on the invoice.

Terms of Sale

Our terms are net 30 from date of invoice, past due thereafter. A service charge of 1.5% per month will be charged on all accounts not paid by the month end. First-time shipments are sent C.O.D. or by credit card. If the first order is over \$500.00, we require payment by cash, money order, or certified check. We also accept Mastercard, VISA, American Express and Discover Card.

Special Orders & Large Equipment

All Purchase orders for large equipment and machines, including, but not limited to, environmental equipment, saws, StoneCyclers, crane systems, and non-stocked or custom products, including special order CNC profile wheels, are subject to a minimum 50% deposit in order to process order. Due to manufacturers' requirements, such orders are non-cancelable and deposits are non-refundable.

Power Tool Repair Policy

GranQuartz is not responsible for the warranty repair and/or maintenance service, please contact the specific tool manufacturer for the closest manufacturer warranty repair center.

- Bosch: 1-800-346-4103
- Skil: 1-800-346-4103

Power Tool Warranties By Manufacturer

Alpha: Alpha power tools offers a one year limited warranty against factory defects on all tools purchased after January 1, 2016. Any tool returned during the warranty period that is found to be damaged or defective due to misuse or normal wear and tear and not as a result of manufacturing or material defects will be quoted a \$30.00 labor fee plus the cost of parts necessary for repair. NOTE: Misuse, improper service, altered, disassembled tools or tools determined to be repaired by an unauthorized service center will be subject to voided warranty. Non-warranty repairs will be charged a \$30.00 bench fee per tool before an estimate for repair is determined. Repaired tools will be shipped back to customer freight pre-paid. All unclaimed tools not resolved within a 90-day period become the property of Alpha. All quoted tools that are processed as Do-Not-Repair-Do-Not-Return (DNRDNR) will be returned to customer at the customer's expense. All tool repairs carry a 30-day warranty. Alpha offers repair centers in the USA. All Alpha warranty and non-warranty repairs are to be sent directly to Alpha repair centers by the customer. Customer is responsible for all freight charges when returning tools to Alpha for repair. An RGA must be obtained from Alpha prior to shipment. Tools may be returned for repair to Alpha Professional Tools, 103 Bauer Dr., Oakland, NJ 07436-3102 (EASTERN USA) Telephone: 800-648-7229, Fax: 800-286-0114, email: tooldesk@alpha-tools.com or [A1 Industrial & eReplacementParts.com](http://A1Industrial.com), 7036 South High Tech Dr., Midvale, UT 84047 (WESTERN USA) Telephone: 801-285-7232, email: dale@replacementparts.com.

Barranca Diamond: All Barranca electric and pneumatic grinding and polishing tools are covered by a 90 day limited warranty against factory defects from the date of purchase. All Barranca warranty and non-warranty repairs are to be sent directly to Barranca or an Authorized Center from the customer (**Romey Power Tool Repair** is authorized by Barranca). Barranca Diamond Products, 1315 Storm Parkway Torrance, CA 90501 Toll-Free: 800-630-7682 Fax: 310-257-3063. Romey Power Tool Repair, 121 Price Hills Trail, Sugar Hill, GA 30518 Telephone: 770-932-8175 Fax: 678-765-2685 romedy121@charter.net.

Hitachi: All Hitachi power tools have a 1 year limited warranty against factory defects from the date of purchase. Hitachi offers a tool replacement for any tool that fails within the first 30 days from the date of purchase (please obtain an RGA from GranQuartz Customer Service prior to replacing the tool). All Hitachi warranty and non-warranty repairs are to be sent directly to Hitachi or an Authorized Repair Center from the customer. For a complete list of service centers, visit www.hitachipowertools.com/index/main-navigation/service-and-support/contact-us.aspx.

Makita: All Makita power tools have a 1-year limited warranty against factory defects from date of purchase. Makita offers a tool replacement for any tool that fails within the first 30 days from date of purchase (please obtain an RGA from GranQuartz Customer Service prior to replacing the tool). All Makita warranty and non-warranty repairs are to be sent directly to Makita or an Authorized Repair Center by the customer. Telephone: 1-800-4MAKITA www.makitatools.com/en-us/Modules/Service/ServiceCenters.aspx

Metabo: All Metabo power tools have a 1-year limited warranty against factory defects from date of purchase. An additional 2-year limited warranty can be obtained if the product is registered at www.metabo.com/xxl. Metabo offers a tool replacement for any tool that fails within the first 30 days from date of purchase. Please obtain an RGA from GranQuartz Customer Service prior to replacing the tool. All Metabo warranty and non-warranty repairs are to be sent directly to Metabo or an Authorized Repair Center by the customer. For a complete list of service centers, visit www.metabo.us/Services-Support.3649.0.html.

Omega Diamond: Tools with limited warranty for 1 year (12

months) and 30-day refund, both from date of purchase include Blue Ripper Jr™ Rail Saw, Blue Ripper Sr™ Rail Saw, Pitbull BigDog™ Stone Chiseler, Red Ripper Jr™ Stone Router and Red Ripper Sr™ Stone Router. Tools with limited warranty for 6 months from date of purchase include Blue Ripper Miter Master™ Rail Saw, Eagle Edger Jr™ Linear Edge Attachment and Red Ripper Ultralight™ Stone Router. All repairs: Many issues are field-serviceable by the owner of the tool, please call one of our technicians to save both time and money.

Warranty repairs: Free factory service, replacement parts, labor, and UPS Ground shipping (see warranty for each tool for details). Customers are required to call prior to returning any unit for service.

Omega Diamond 10125 Ophir Rd Newcastle, CA 95658-9504 Ph: 888-996-4777 Fax: 530-885-3785 Non-warranty repairs: Parts or upgrade kits are available for purchase for all tools and paid factory service is available. Customers are required to call prior to returning any unit for service. On these products Omega Diamond's warranty excludes the motor. Motor warranted under motor manufacturer warranty, if available.

Omni Cubed: Omni Cubed offers a limited warranty for a period of ONE YEAR from the date of purchase (i.e. receipt or invoice date). For Omni Cubed vacuum pumps sold after 10/15/2009, online registration at www.omnicubed.com/ registration is required to receive this full year of coverage (otherwise the pump warranty defaults to 6 months from purchase date). This warranty covers all defects in workmanship and materials for Omni Cubed products. This warranty only covers defects arising under normal usage. This warranty applies only to the original purchaser, and is non-transferable. This warranty does not cover malfunctions, failures, or defects resulting from misuse, abuse, neglect, accident, alteration, or lack of proper maintenance. This warranty also does not cover modifications or repairs performed by entities other than Omni Cubed authorized service personnel. Omni Cubed will either replace the product, or repair any defects in workmanship or materials, at their discretion and without any charge to the customer. The customer will need to pay for replacement parts, labor charges, and total freight charges after the one year limited warranty expires, and in all cases when the damaged or failed part has resulted from misuse, abuse, neglect, accident, alteration, lack of proper maintenance, or modification/repair performed by an entity other than Omni Cubed authorized service personnel. This warranty gives the customer specific legal rights; the customer may have additional rights applicable to this warranty. The customer will need to return the warranted product, freight prepaid, along with an RMA (returned merchandise authorization) form and number obtained from our Customer Service Center. Contact the Omni Cubed Customer Service Center via email at customerservice@omnicubed.com, or by phone at (877) 311-1976, to request an RMA form. The form will either be emailed or faxed directly to the customer, which will contain the RMA number assigned to your return. Returns will not be processed without a valid RMA number. RMA numbers are only valid for 30 days from the date of issuance. Return the product (including all related components) to the Omni Cubed Exchange Center noted on the RMA form. Be sure to include: completed RMA form (which was provided to you and contains your RMA number), proof of purchase documentation. Omni Cubed recommends that the customer fully insures the package being returned. Omni Cubed also suggest that a "traceable carrier" that can provide a "proof of delivery" be used to ship the return. Omni Cubed shall not be responsible for items returned that are lost or damaged in transit.

(Continued next page)

Pearl: All PEARL tile saws have a 1 year limited warranty against factory defects from the date of purchase. All PEARL warranty and non-warranty repairs are to be sent directly to a PEARL Authorized Repair Center from the customer. For a complete listing of Pearl Repair Centers, please visit <http://www.pearlabrative.com/Custom/Pages/ServiceCenters.aspx>

Private Label Brands: Refers to All GranQuartz®, Pro Series®, Assassin®, and Diarex® branded air polishers. GranQuartz's private label tools have a 30 day limited warranty against factory defects from the date of purchase. All warranty repairs or out of warranty repairs should be sent directly to Rometry Power Tool Repair from the customer. Rometry Power Tool Repair, 121 Price Hills Trail, Sugar Hill, GA 30518. Telephone: 770-932-8175 Fax: 678-765-2685 romedy121@charter.net

Magnum Routers: All warranties begin at the date of purchase. Magnum routers have a 90 day limited warranty on electrical components and a 6 month limited warranty on mechanical components. All Magnum warranty and non-warranty repairs are to be sent directly to Nytech Industries or an Authorized Repair Center from the customer. Nytech Industries is located at 24253 County Rd., St. Cloud, MN 56301. Telephone: 320-240-9033, Fax: 320-240-9118 nytech@cloudnet.com. Rometry Power Tool Repair is authorized by Nytech and are located at 121 Price Hills Trail, Sugar Hill, GA 30518. Telephone: 770-932-8175 Fax: 678-765-2685 romedy121@charter.net

•Warranty begins on the date of invoice, not the first day of use on the power tool.

•For non-warranty repairs of GranQuartz private label Power Tools, there will be a minimum non-refundable charge of \$50 to inspect and diagnose a tool. The \$50 nonrefundable fee must be paid in advance (no COD accepted). Should the customer wish to proceed with a repair of a GranQuartz Power Tool, this \$50 charge will be credited to the final cost of the repair.

•An RGA number is required and the customer is responsible for all freight charges to and from our warehouse. No repair will be shipped on C.O.D basis, but must be paid for by cash or credit card in advance of shipment.

Return Policy

A Return Authorization Number (RGA#) is required for all product returns. An RGA# and shipping instructions can be obtained by contacting Customer Service. No returns will be accepted without an RGA#.

GranQuartz Customer Service: 800-458-6222

- A 15% re-stocking fee will be applied to all returned goods on stock material (non-defective products).
 - All returns must be shipped back in original, unopened packaging in order to receive credit.
 - No returns authorized after 90 days from date of purchase.
 - No returns will be accepted or credit issued on used products, unless they are proven to be defective.
 - All claims of shortages must be reported to customer service within 48 hours of receipt.
 - No returns will be authorized on Hazmat products, chemicals, or adhesives.
 - No returns will be authorized on special order items including special order CNC tools.
 - Customers must pay shipping charges on all returns.
- Upon receipt and inspection of the product return, GranQuartz will issue a refund on shipping charges if it is proven that there was a shipping error or the product was defective.
- Returns are limited to 10% of the previous 12 months net purchases.

PLEASE CHECK ALL CARTONS CAREFULLY

Shipping Addresses:

GranQuartz-East
3950 Steve Reynolds Blvd.
Norcross, GA 30093

GranQuartz-West
4900 Zambrano St.
Commerce, CA 90040

Mailing Address:

GranQuartz
P.O. Box 1767
Norcross, GA 30091-1767

All purchases made from this catalog are subject to GranQuartz's Terms of Sale, (available at: www.GranQuartz.com/termsforsale). By purchasing any products through this catalog, you expressly accept and agree to such terms.

The information provided in this catalog is for general information purposes only and GranQuartz does not guarantee that it is accurate, current or complete. GranQuartz reserves the right to correct any errors, inaccuracies or omissions and to change or update information at any time without prior notice (including after you have submitted your order). Please note that such errors, inaccuracies or omissions may relate to product description, pricing and availability. Photos may vary. Pricing and shipping and handling rates are subject to change after publication without notice. We apologize for any inconvenience this may cause you.



113M.....	198	Colorants	182-183,189	Farnese® EasySink CNC Sink Machine	128
Aardwolf Lifters.....	136	Cones	92-93	Farnese® Linx Plus Bridge Saw	125
Acrylics.....	184	Contour Blades.....	10-11	Farnese® MARC5 5-Axis CNC Bridge Saw.....	124
Adapters	63	Convex Pads	49	Farnese® Miter Saw.....	127
Adhesive Accessories	188-193	Cook Top Bags.....	167	Farnese® Studio Block Saw.....	129
Adhesives.....	179-188	Corbels.....	168	Felt Buffing Pads	203
ADJ® Auto Edge.....	108-110	Core Bits	57-62	Fiberglass Rodding	168
ADJ® Falcon Finger Bits.....	90	Countertop Films	167	Filler Sticks.....	167
ADJ® Porcelain/Glass Bridge Saw Blade	28	Countertop Support Systems.....	156-159	Filter Cloths	121
ADJ® Mitre Ninja Pre-Cut Bits	88	Cranes.....	134	Five Step Systems.....	97
Advant Edge® CNC Dressing Machine	95	Cup Wheels.....	64-67, 133	Flip Cart.....	140
A-Frames.....	139-140, 145	Cyanoacrylate Glues	170	Floor Grinding & Polishing.....	171-178
Aging Brushes	108, 112	Diarex® Marble Blade.....	26	Floor Machines.....	171-172, 177
Aging Products.....	197	Dia-Glo Products.....	202	Flush-Mount Flanges.....	17
Air Polishers.....	215-217	Diamond Hand Pads.....	55, 178	Flute Grinding & Polishing System.....	232
Alpha® Summit Wheels	113	Diamond Polishing Pads.....	35-50	Frankfurt Tooling	112
Anchor Bits and Adaptors	75, 236	Dicalite®	121	Glass Cutting Blades	15, 27-28
Anchor Epoxy.....	167	Diarex® Resin Filled Cup Wheels.....	67	Glossfire® Disks & Wheels	101-102
Antiquing Brushes	108-109, 112	Diarex® 3-Step Hybrid Polishing Pads.....	39	Gloves	190
Aprons, Waterproof.....	206	Diarex® Vanity Disc Combo Cutting/Grinding	8	Glue Gun	192
Assassin® Electroplated Marble Blades	8	Die Grinder Bits.....	76	Gorilla Grip®.....	159
Auto Edge Tools	96-110	Die Grinders	218	Granite Grabbers® Dishwasher Mounting	163
Backer Pads.....	154, 220	Dishwasher Bracket.....	164	GranQuartz® 600 Cordless Hot Glue Gun.....	192
Back-Up Heads	154, 220	Disco Blue® Marble Blade.....	26	Grinders	212-213
Beaver Edge Chiseler.....	232	Diskit Pads.....	178	Grinder Caddy.....	237
BigDog Stone Chiseler.....	232	Dollies	141, 150-152	Grinding Wheels.....	63
Black Magic® Bridge Saw Blade.....	21	Dongsin® Easy Bit Incremental Finger Bits.....	111	Grout Sponges.....	170, 210
Black Magic® D Fiber Cup Wheels.....	65	Dongsin® Electroplated Multi-Cutter	8	Hand Pads.....	55, 178
Black Magic® Polishing Pads, Wet Use.....	35	Dongsin® GMB Remover.....	66	Harborlite®.....	121
Blade Roller.....	237	Dongsin® Milling Wheels.....	34	Hearing Protection.....	209
Blind Hole Bits	62	Dongsin® Top Polishing Discs.....	113	Hide A Scratch	170
Blue Ripper Saws.....	224	Dongsin® Turbo Rounder Cup Wheels.....	65	Hoists	134
Booms.....	146-147	Dressing Blocks	63	Honing Powder.....	201
Boots, Waterproof	205	Dressing Tool.....	68	Hopper	140
Brace Setters.....	165	Drill Bits	62	Hot Glue Guns.....	192
Bridge Saw Blades.....	18-33	Drum Wheels.....	56, 114-115	Hot Stuff Glue.....	170
Bridge Saws.....	124-125, 226-231	Drums.....	114-115	Hydrocycler.....	121-122
Buffing Pads.....	174, 203	Dry Core Bits.....	57-60	HydroSettler.....	122
Bundle Racks.....	148	Dry Polishing Pads.....	43-45	HydroQuad Adapters.....	17
Burr Sets, Electroplated.....	76	DS 3011 3-Head Planetary Polisher	235	Impregnators	194-198
Bush Hammer Plates.....	114	DuraPro® Steel Toe Work Boots.....	205	Irwin® C-Clamps	204
Carry Clamps.....	149, 153	Dust Masks	120, 207-208	Irwin® Quick-Grip SL300 Bar Clamps	204
Carts	140, 143-145, 152-153	Dustless Tools	116-119	Incremental Finger Bits.....	111
Caulk and Caulk Guns.....	192-193	Eagle Edger Jr.	224	Italian Craftsmen Polish.....	203
Caulk-EZ.....	193	Ear Muffs.....	209	Jet Stik® Flaming Tool.....	232
Chamfer Wheel.....	107	Ear Plugs.....	209	Jib Cranes	134
China Markers	210	Eibenstock Saw.....	223	König® GST Mitre Blades.....	29
Chip Repair Kit.....	170, 191	Edge Breakers	74	König® Razor Mitre Blades.....	29
Cinclips	164	Edge Polish Machine.....	123	Klindex Planetary Machine.....	235
Circular Saws	222-223	Edge Seamer.....	156	Lam-Clamps	154
Clamps	154, 204	Electroplated Blades.....	8-11	Latapoxy	187
Cleaners.....	198-199	Engineered Stone Pads.....	47	Latex Gloves.....	190
Cluster Wheel, Cyclone®.....	66	Epoxies.....	181-187	Leather/Antiquing Brushes	108-109
CNC Blades	96	EZ Dishwasher Bracket	164	Legend® Cerberus Bridge Saw Blades.....	19
CNC Cones	92-93	EZ Sink Bracket.....	164	Legend® Hybrid Poly-Epoxy Adhesives	179
CNC Core Bits.....	61, 94	EZ Sink Installation Tool.....	163	Legend® Premium Polyester Adhesive.....	179
CNC Dressing Blocks & Stones.....	63, 96	Fab King® Sink Cutout Machine.....	127	Legend® Router Bits.....	71
CNC Finger Bits	89-91	Fabrication Chemicals.....	194-199	Lifters	130, 135-137
CNC Stubbing Wheels.....	92	Fabrication Stands.....	139, 145, 149	Loc-Line Flexible Water Line.....	237
CNC Tooling	80-95	Fabrication Tables	138, 141-142, 149	Mandrels	111
CNC Vacuum Pods.....	77-79	Fabricator's Friend Sleeve Protectors.....	206	Mangia Macchia.....	199
Coilhose Blow Guns.....	210	Face Polishing Tool Combo Package	55	Manzelli® Vacuum Lifters.....	130, 135-136
Color Enhancers.....	194-198	Farnese® Alexia Sink Cutout Machine.....	126	Marble Blades	8-9, 11-12, 25-26

Masking Tape.....	191	Pro Series® Vacuum Brazed Core Bits.....	61	Stone Pro® SR2 Vacuum Support Rail System.....	159
Masks, Protective.....	207-208	ProSpec B-150 Epoxy.....	187	Strap Anchors.....	75
Master Tre® Brushes.....	108	Protective Film.....	167	Stubbing Wheels, CNC.....	92
Metal Dot Polishing Pads.....	47	PVA Wheels.....	54	Suction Cups.....	156, 160-161
Metal Polishing Pads.....	47	QRS Sandpaper Discs.....	51	Superior® Gold Adhesive.....	180
MFP5 Profile Wheels.....	81, 88	Quartz Renew Restoration Products.....	50	Superior® Pearl Adhesive.....	181
Milling Wheels.....	34	Quartzite Bridge Saw Blades.....	30-32	Superior® V-Max Adhesives.....	181
Miracle Sealants.....	198	Racks.....	138-139, 145	Super-Z Profile Wheels, ADI.....	88
Miter Blades.....	29, 33	Radial Arm Tools.....	111-115	Surface Prep Tools.....	171
Miter Clamps.....	154, 204	Rags.....	191	Swing Machines.....	172
Miter Saw.....	127	Rail Saws.....	224-231	T-31 Anchors and Anchor Bits.....	236
Mixing Cups.....	191	Ratchet Straps.....	137	T-31 Machines.....	236
NCF Stone Accelerator for Cyanoacrylates.....	170	Razor Blades.....	170, 211	Tables.....	138, 141-142
Ninja Pre-Cut System.....	88-89	Recon® Polyester Adhesive.....	179	Tape.....	191
Nitro One Shot Adhesives.....	188	Recon® Segmented Blades.....	17	Tape Measures.....	210
No-Spin Edger (Omni Cubed).....	154	Respirators.....	120	TapFlex Wheels.....	109
NSI Solutions® Sink Bull™.....	221	Revere® Sinks.....	162	Tenax® Aging Brushes.....	108
Omni Cubed® Products.....	130, 151-158	Rigid Aluminum Backup Heads.....	219	Tenax® Adhesives.....	186-187
Omni Cubed® Pro Anchor T-31 System.....	236	Rockbiter Stone Chisel.....	232	Tenax® Glaxs.....	186
Orbital Sander.....	49	Rodding Blades.....	16-17	Tenax® Stone Fabrication Chemicals.....	195, 197
Over Head Cranes.....	134	Router Bits.....	69-74	Thinwall Core Bits.....	58
Paint Markers.....	210	Routers.....	224, 233-235	Tile Core Bits.....	61-62
Pearl® P2 Pro-V Glass Blade.....	15	Rubbing Stones.....	54	Tile Blades.....	13
Pearl® P2 Pro-V Porcelain Blade.....	14	Rust Remover.....	198-199	Tile Saws.....	225-228
Pearl® P4 Pro-V Porcelain Blade.....	15	Safety Glasses.....	208-209	Tool Oil (Pneumatic).....	210, 215
Pearl® P4 Core Bit.....	60	Sanders.....	213, 218	Tornado System.....	63
Pearl® P5 Core Bit.....	60	Sandpaper.....	51-54	Track Saws.....	224-225
Pearl® P5 Glass Blade.....	15	Saws.....	222-231	Transport Racks.....	138-140, 145
Pearl® P5 Professional Core Bit.....	57	Scrim Cloth.....	192	Tuck Point Blades.....	16
Pearl® P5 Reactor Pro II Bridge Saw Blade.....	18-33	Seam Phantom.....	221	Turbo Blades.....	3-7
Pearl® Silicon Carbide Turbo Cutting Discs.....	53	Seam Polishing.....	48	Turbo Discs.....	49
Perlite.....	121	Seam Setters.....	157-160	Tuscan Leveling®.....	132
Planetary Floor Machines.....	177	Self-Locking Trolley.....	150	UCS (Ultra Compact Surfaces) Blades.....	133
Planetary Polisher.....	235	Shims.....	166	UHS® Profile Wheels.....	84-87
Pneumatic Altima® Adhesives Gun.....	189	Shop Wipes.....	191	Utility Knife.....	211
Pneumatic Grinders.....	217	Silicon Carbide Wheels.....	54, 68	UV Stone Repair Kit.....	191
Pneumatic Polishers.....	215-217	Sink Anchors.....	164	Vacuums.....	118
Pneumatic Alpha® Saw.....	223	Sink Bull (NSI).....	221	Vacuum Cups.....	156, 160-161
Polishers.....	214-218	Sink Clips.....	164, 236	Vacuum Lifters.....	135-137
Polishing Bars.....	203	Sink Drums.....	114	Vacuum Pods.....	77-79
Polishing Bricks.....	112	Sink Hole Saver, Omni Cubed.....	156	Variable Speed Grinders.....	212
Polishing Drums.....	56	Sink Installation.....	163-164	Velcro® Strips.....	220
Polishing Fluids.....	200, 203	Sinkits LC (Low Clearance) Brackets.....	163	Vitrified Polishing Pads.....	46
Polishing Pads.....	35-51	Sink Setters.....	163	VTX® Gold Maintenance Pads.....	174
Polishing Powders.....	201-203	Sinks.....	162	VSM® Sandpaper.....	53
Polyester Adhesives.....	179-182	Slab Racks.....	138, 147-148	Water Fed Polishers.....	214-217
Porcelain Blades.....	13-15, 27	Sleeve Protectors, Waterproof.....	206	Water Proof Clothing.....	205-206
Poultice Products.....	199	Smart Spacer.....	169	Water Recycling Systems/Supplies.....	121-122
Power Cords.....	237	Snail Lock Adapters.....	110	Waxes.....	200
Pro-Cart® (Omni Cubed).....	152	Specialty Blades.....	12-17	Wedgie™ Safety Tool.....	137
Pro-Dolly® (Omni Cubed).....	152	Specialty Polishing Pads.....	43-45	Wet Core Bits.....	57-58
Pro-Lift® (Omni Cubed).....	153	Sponges.....	170, 210	Wet Polishing Pads.....	35-42, 44-47
Profilers.....	74	Spray Adhesive.....	52	Work Station Cranes.....	134
Profiling Bits.....	74, 76	Square.....	211	Work Tables.....	138, 141-142
Propane Floor Burnishing Equipment.....	171	Squeegees.....	211	Zenesis® II Bridge Saw Blade.....	24
Pro Series® Bridge Saw Blades.....	20	Stealth Seamer.....	157-158	Zenesis® CNC Fingerbits.....	91
Pro Series® Copper Polishing Pads.....	47	Steel Wool Pads-Floor.....	175	Zenesis® Dry Core Bits.....	60
Pro Series® Hand Pads.....	55, 178	Steel Wool-Hand Held.....	200	Zero Tolerance Wheels.....	115
Pro Series® Marble Blade.....	25	Stir Sticks.....	191	Zoller® SMILE Pilot CNC Tool Preset System.....	95
Pro Series® Seam Polishing.....	48	Stone Braces.....	165	Xtreme™ Fabrication Table.....	138
Pro Series® Thin Wall Core Bit.....	58	Stone Chiseler Tools.....	232	Xtreme™ Slab Rack Kits.....	138
Pro Series® Turbo Tuck Point Blades.....	16	Stone Repair Products.....	170, 191	Xtreme™ Transportation Rack.....	138

What You Need, When You Need It!

Biggest Product Variety & Inventory in The Stone Industry!



Best Selection of
Blades & Pads
Pages 3-50



Precision Quality
CNC Tooling & Equipment
Pages 80-96

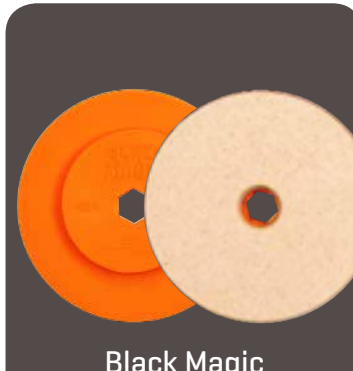

Black Magic
Combo Wheels
Page 105



Full Line of Power Tools
and Accessories
Pages 212-237

granquartz.com • 800.458.6222

NEW!



Manzelli® EXE 16PN GRES
Thin Material Vacuum Lifter
Page 130

NEW!



ELaser™ XPress 2D/3D
Digital Templating System
Page 123

NEW!



Duroair
the evolution of air

DuroTower
Automatic
Cleaning Systems
Page 116

NEW!



Omni Cubed S3-Slim Slab Saver
Porcelain Frame
Page 130